

**Elastohydrodynamic Lubrication with Polyolester
Lubricants and HFC Refrigerants**

Final Report

VOLUME II

RAW DATA

APRIL 1999

Selda Gonsel
Michael Pozebanchuk

Pennzoil Products Company
Technology Center
1520 Lake Front Circle
The Woodlands, TX 77380 USA

Prepared for:
The Air Conditioning and Refrigeration Technology Institute
under
ARTI MCLR Project Number 670-54400

“This research project is supported, in whole or in part, by U.S. Department of Energy grant number DE-FG02-91CE23810: Materials Compatibilities and Lubricants Research (MCLR) on CFC-Refrigerant Substitutes. Federal funding supporting the MCLR program constitutes 93.57% of allowable costs. Funding from the air-conditioning and refrigeration industry supporting the MCLR program consists of direct cost sharing of 6.43% of allowable costs and significant in-kind contributions.”

EXECUTIVE SUMMARY

Lubrication properties of refrigeration lubricants were investigated in high pressure nonconforming contacts under different conditions of temperature, rolling speed, and refrigerant concentration. The program was based upon the recognition that the lubrication regime in refrigeration compressors is generally elastohydrodynamic or hydrodynamic, as determined by the operating conditions of the compressor and the properties of the lubricant. Depending on the compressor design, elastohydrodynamic lubrication conditions exist in many rolling and sliding elements of refrigeration compressors such as roller element bearings, gears, and rotors.

The formation of an elastohydrodynamic film separating rubbing surfaces is important in preventing the wear and failure of compressor elements. It is, therefore, important to predict the elastohydrodynamic (EHD) performance of lubricants under realistic tribocontact conditions. This is, however, difficult as the lubricant properties that control film formation are critically dependent upon pressure and shear, and cannot be evaluated using conventional laboratory instruments.

In this study, the elastohydrodynamic behavior of refrigeration lubricants with and without the presence of refrigerants was investigated using the ultrathin film EHD interferometry technique. This technique enables very thin films, down to less than 5 nm, to be measured accurately within an EHD contact under realistic conditions of temperature, shear, and pressure. The technique was adapted to the study of lubricant/refrigerant mixtures. Film thickness measurements were obtained on refrigeration lubricants as a function of speed, temperature, and refrigerant concentration. The effects of lubricant viscosity, temperature, rolling speed, and refrigerant concentration on EHD film formation were investigated. From the film thickness measurements, effective pressure-viscosity coefficients were calculated.

The lubricants studied in this project included two naphthenic mineral oils (NMO), four polyolesters (POE), and two polyvinyl ether (PVE) fluids. These fluids represented viscosity grades of ISO 32 and ISO 68 and are shown in the [table below](#). Refrigerants studied included R-22, R-134a, and R-410A. Film thickness measurements were conducted at 23 °C, 45 °C, and 65 °C with refrigerant concentrations ranging from zero to 60% by weight.

Refrigerant	Lubricant	Commercial Identification
R-22	ISO 32 Naphthenic Mineral Oil (NMO-32) ISO 68 Naphthenic Mineral Oil (NMO-68)	Suniso 3GS Suniso 4GS
R-134a	ISO 32 Polyolester (POE-32) ISO 32 Polyvinyl Ether (PVE-32) ISO 68 Polyolester A (POE-68A) ISO 68 Polyolester B (POE-68B) ISO 68 Polyolester C (POE-68C) ISO 68 Polyvinyl Ether (PVE-68)	ICI Emkarate RL 32H Idemitsu Kosan FVC 32B ICI Emkarate RL 68H Mobil EAL 68 CPI Solest 68 Idemitsu Kosan FVC 68B
R-410A	ISO 32 Polyolester (POE-32) ISO 32 Polyvinyl Ether (PVE-32) ISO 68 Polyolester A (POE-68A) ISO 68 Polyvinyl Ether (PVE-68)	ICI Emkarate RL 32H Idemitsu Kosan FVC 32B ICI Emkarate RL 68H Idemitsu Kosan FVC 68B

All of the lubricants studied behaved as expected from the EHD theory under air. EHD film thickness increased with speed and dynamic viscosity and decreased with temperature. Effective pressure-viscosity coefficients (α) calculated from the film thickness data showed the effect of chemical structure on the pressure-viscosity characteristics of the fluids. The fluids were ranked with respect to their pressure-viscosity coefficients in the following order:

naphthenic mineral oils > polyvinyl ethers > polyolesters.

Differences were observed in the pressure-viscosity characteristics of the polyolesters studied. This was related to the degree of branching in the ester structure. Esters with branching have higher α -values than those with linear structure. Effective pressure-viscosity coefficients also change with temperature, decreasing as the temperature increases.

Refrigerants have a significant effect on reducing the EHD film formation ability of lubricants. EHD film thickness decreases drastically in the contact as the refrigerant concentration in the lubricant increases. Even at the low refrigerant concentration of 10%, the reduction in film thickness ranges from 30 to 65% depending on the test temperature. Refrigerants reduce dynamic viscosity as well as the pressure-viscosity coefficients of lubricants. However, this effect decreases as the temperature increases. The thickness of the EHD film formed by the lubricant/refrigerant mixtures show a similar dependence on speed as that of the lubricant itself. Under some conditions (high refrigerant concentrations, high

temperatures and pressures), some deviations were observed from the EHD theoretical slope for the film thickness/speed relationship.

Effective pressure-viscosity coefficients for the lubricant/refrigerant mixtures were calculated from the film thickness data using the theoretical relationship of Dowson-Hamrock and dynamic viscosity data available for the mixtures in the literature. The accuracy of the calculated pressure-viscosity coefficients depends strongly on the accuracy of the dynamic viscosity data used in the calculations.

For a given refrigerant and lubricant mixture, pressure-viscosity coefficient increases linearly in proportion to the logarithm of dynamic viscosity as shown below. This finding suggests that the same fundamental molecular properties govern changes in both dynamic viscosity and pressure-viscosity properties of fluids.

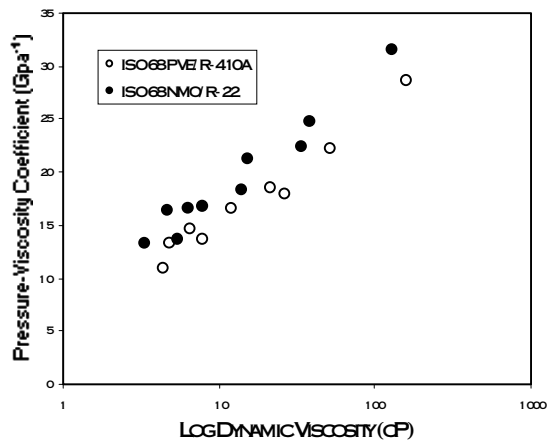

The ranking obtained with respect to the pressure-viscosity characteristics of the lubricants under air was also observed under refrigerant environments. However, the differences became smaller as the refrigerant concentration and the temperature increased. In general, refrigerant (R-134a or R-410A) mixtures with polyvinyl ethers have higher α -values than those with polyolesters. Mixtures of naphthenic mineral oil and R-22 have higher α -values than those of polyolesters or polyvinyl ethers and R-134a or R-410A.

The presence of R-410A in the lubricants (polyolesters or polyvinyl ethers) results in thinner EHD films, as shown below, than those produced by the same lubricants in the presence of R-134a.

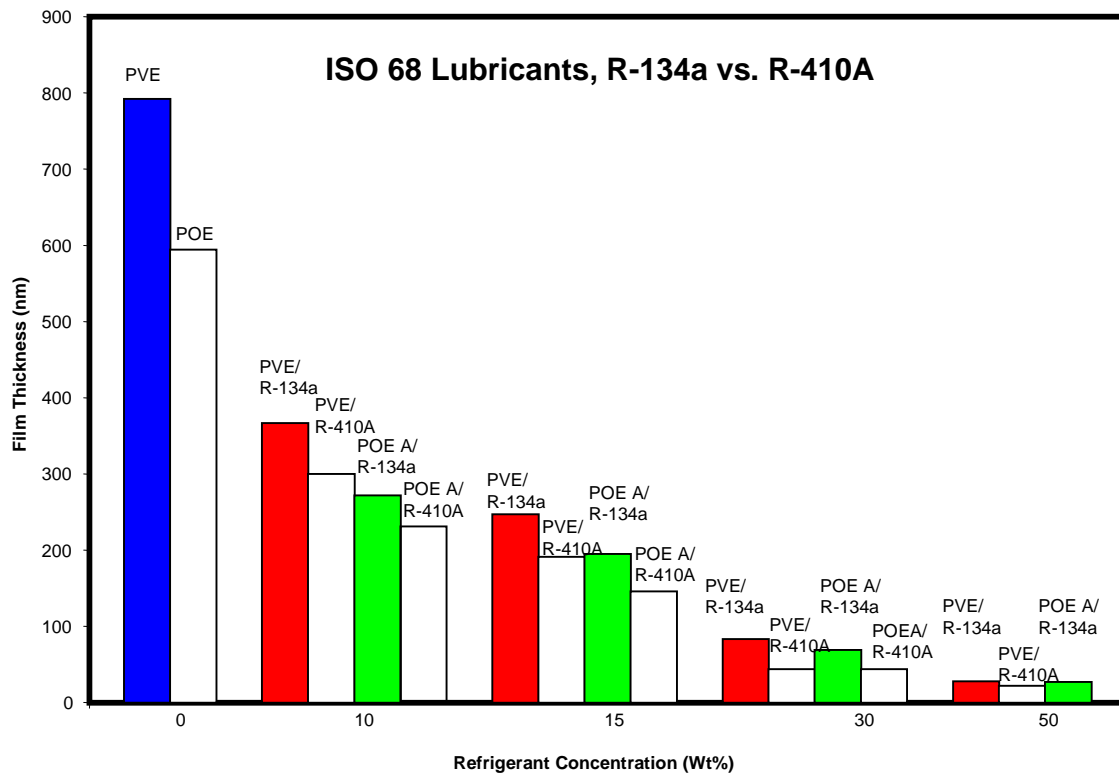

A graphical ranking of all the tested lubricant/refrigerant combinations is shown in the charts below. The film thickness data reported in these charts were obtained under the same conditions of temperature (22.5 °C) and speed (0.8 m/s) for ISO 32 and ISO 68 lubricants and their mixtures with refrigerants.

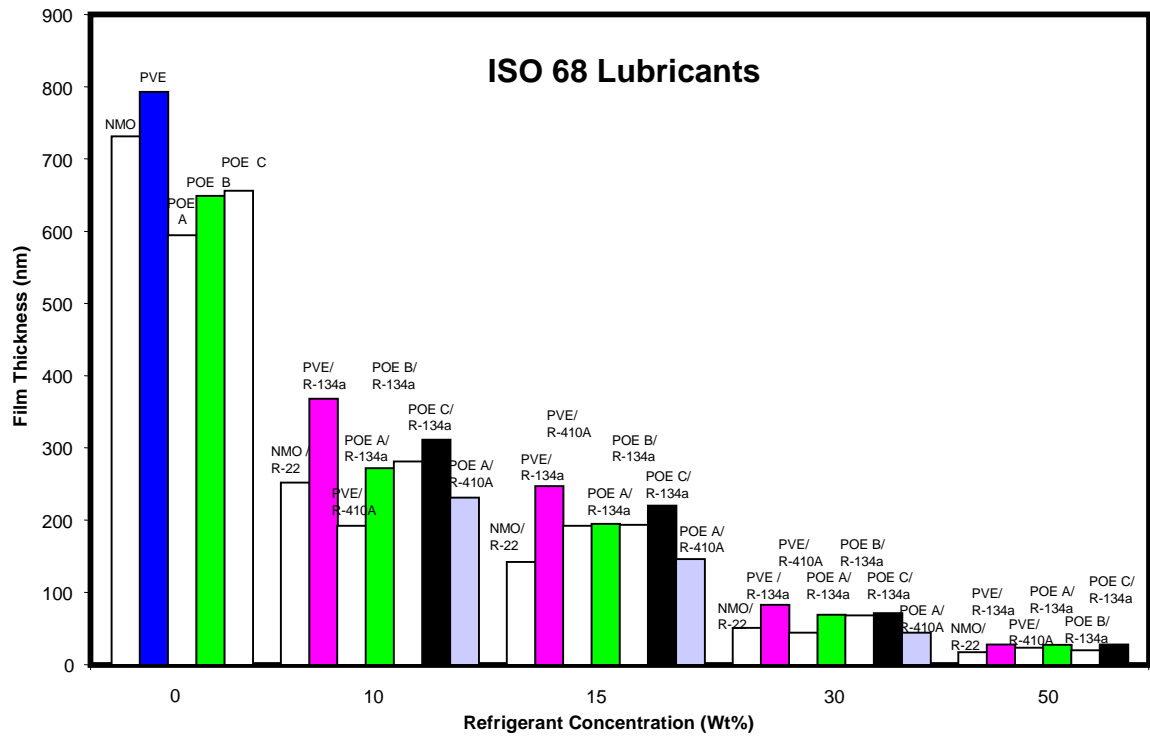
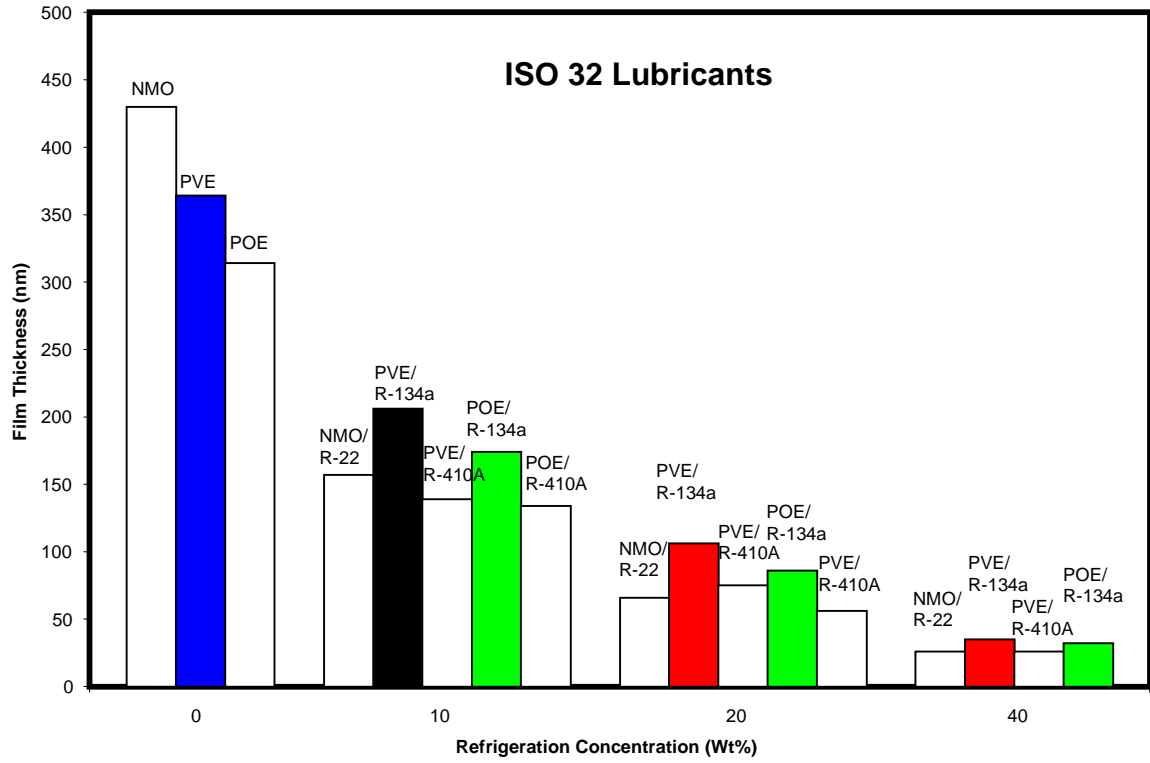

Based on the results of the current study, future areas of investigation were identified. These areas concentrate on 1) ways to improve the accuracy of the dynamic viscosity and pressure-viscosity coefficient determinations on lubricant/refrigerant mixtures, and 2) evaluation of EHD friction (traction) properties of lubricant/refrigerant mixtures. This work would be useful for modeling viscosity and pressure-viscosity characteristics of lubricant/refrigerant mixtures, and for determining and optimizing lubricant behavior in EHD contacts of refrigeration compressors.

EXPERIMENTAL SECTION

Optical Interferometry

[Figure 1](#) shows the principles of optical interferometry as applied to an EHD contact. The EHD contact can be formed by a steel ball loaded against a flat disc as a contact geometry equivalent to many nonconforming contacts of practical importance. Either the ball or the disc can be driven to give varying slide-to-roll ratios, simulating conditions found in practice. The disc is transparent to visible light, and the EHD film generated is measured by the observation of interference color within the contact. This technique has been very useful in studying EHD behavior of lubricants since the wavelength of light is of the same order as a typical EHD lubricant film.

The surface of the glass disc shown in [Figure 1](#) is coated with a thin (20 nm) semi-reflecting chromium layer. Light is shone into the contact through the glass disc. Some of this light is reflected from the underside of the disc and some passes through the lubricant's film and is reflected back from the steel surface. Since the two beams of light travel different distances, when they recombine they interfere either constructively or destructively, according to [Equations 1 and 2](#) below, and produce colored interference patterns which are characteristic of the lubricant film thickness. The lubricant film thickness, which is represented by the optical path difference between the two beams, is determined by studying the intensity of the recombined beam.

Destructive interference:

$$h_{\text{oil}} = \frac{(N + \frac{1}{2} - \phi) \lambda}{2n \cos \theta} \quad N = 0,1,2 \quad \text{Equation 1}$$

Constructive interference:

$$h_{\text{oil}} = \frac{(N - \phi) \lambda}{2n \cos \theta} \quad N = 1,2,3 \quad \text{Equation 2}$$

where h = lubricant film thickness

N = fringe order

ϕ = net phase change

λ = wavelength of interfered light

n = refractive index of lubricant

θ = angle of incidence

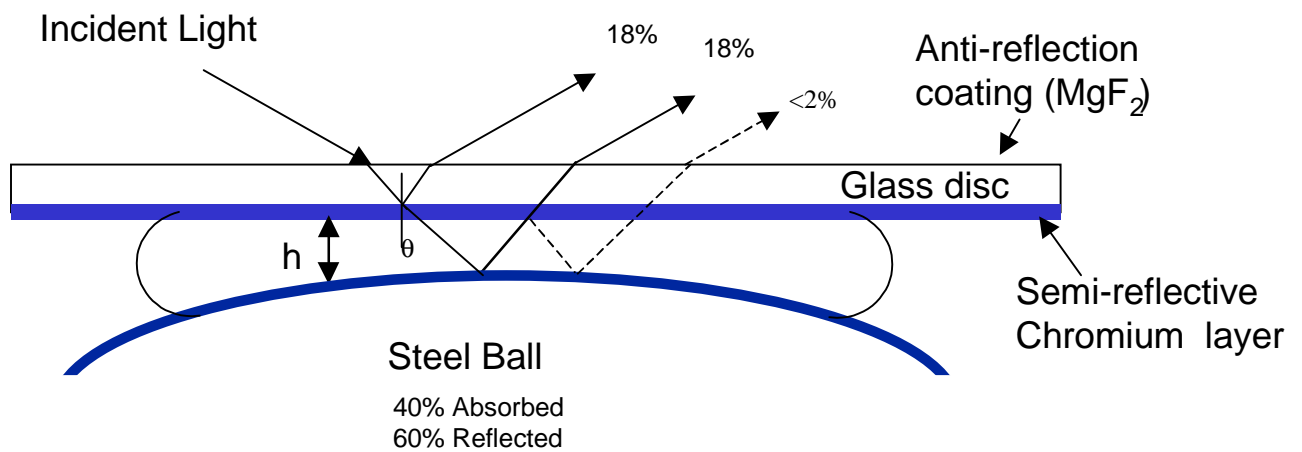

Figure 1. Principle of optical interferometry

The optical interferometry technique has been a useful tool for measuring lubricant film thickness in EHD contacts. This technique, however, also has some significant limitations with respect to the thickness of the films measured and the precision of the measurements. For example, for vertical illumination Equation 3 reduces down to the following equation for the first fringe:

$$nh_{\text{oil}} = \frac{\lambda}{4} \quad \text{Equation 3}$$

This indicates that the first fringe occurs at the wavelength of visible light divided by four, which means that the thinnest films that can be measured by conventional optical interferometry are around 80 to 100 nanometers. This limitation has been overcome by the development of the “ultrathin film EHD interferometry” technique which is described in [Section 5.0 \(1\)](#).

Ultrathin Film Interferometry Method – Lubricant Film Thickness Measurements

Ultrathin film interferometry method (1) was adapted to measure film thickness of lubricant and refrigerant mixtures. This method is an extension of conventional optical interferometry that permits very thin films, down to less than 5 nm, to be measured accurately within an EHD contact. This technique can be used to study lubricant behavior in EHD as well as in mixed lubrication regimes. It is particularly useful for measuring film thickness for low viscosity fluids and/or under high temperatures. It has been successfully applied to study the EHD behavior of lubricant base oils, antiwear additives, metalworking fluids and polymers used as viscosity index improvers in lubricants (2-8). Some preliminary studies were also conducted on refrigeration lubricants (9).

The test set-up is shown schematically in [Figure 2](#). A highly polished steel ball (AISI 52100, 19.05 mm diameter, 11 nm RMS surface roughness) is loaded against the underside flat surface of a rotating transparent glass disc to form a circular concentrated EHD contact. The underside of the chromium-plated glass disc is coated with a spacer layer of transparent silica of about 500 nm thickness. The composite surface roughness of the undeformed surfaces is 11 nm.

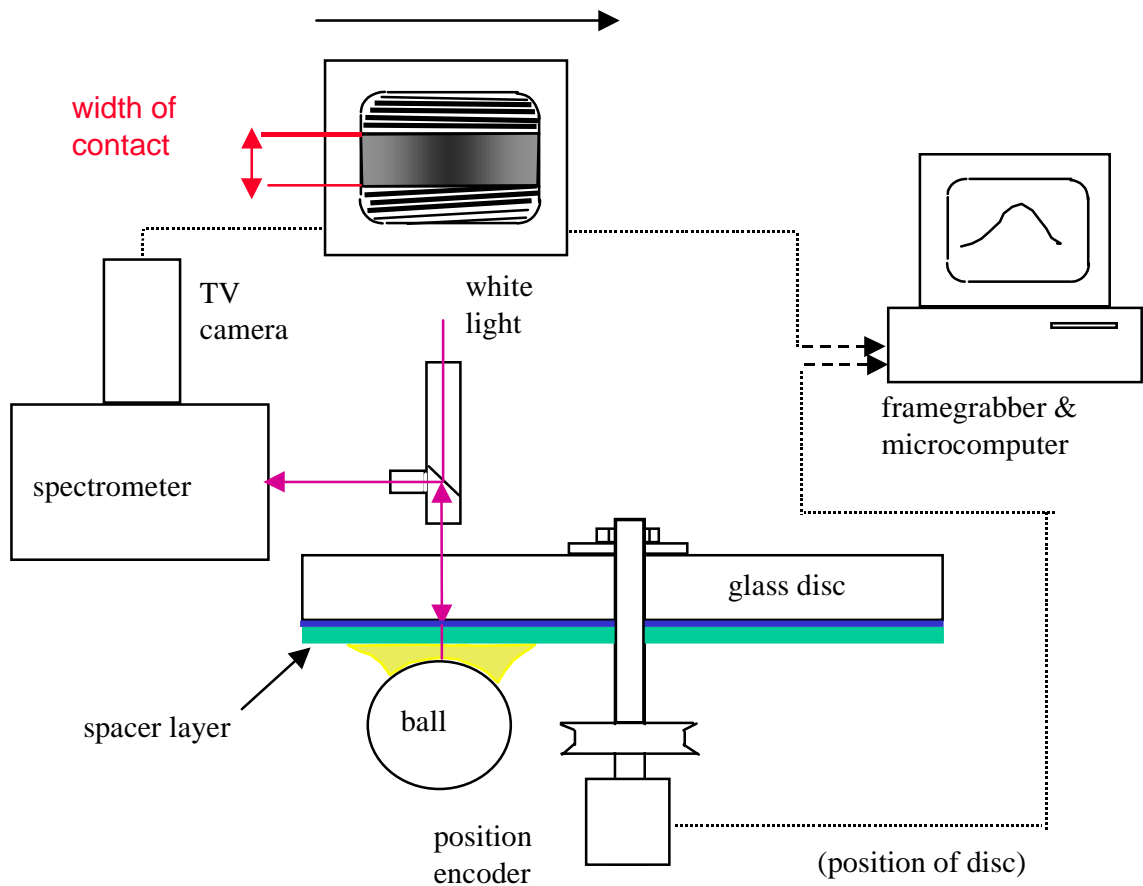

Figure 2. Schematic set-up for ultrathin film interferometry

The ball is contained in a lubricant bath and is driven by the disc in nominally pure rolling. The lubricant is filled halfway to the top of the ball, so that the lubricant is entrained into the contact by the rolling motion of the ball. The test lubricant is enclosed in a stainless steel chamber and a heat insulation lid sits on top of the glass disc. This helps to maintain constant test temperature and protects the lubricant from exposure to the outside environment. The test temperature is controlled using heating rods embedded in the chamber walls and is monitored near the contact inlet using a digital thermometer. The temperature can be controlled to a set value within ± 0.5 °C.

Lubricant film thickness is determined by optical interferometry as shown schematically in [Figure 3](#). White light is shone into the contact and some is reflected from the chromium layer, while some passes through the silica spacer layer and any lubricant film present to be reflected from the ball. The two beams recombine and interfere. The interfered light from the contact is passed into a spectrometer where it is dispersed and detected by a solid state, black and white TV camera as shown in [Figure 2](#). A framegrabber is used to capture this image and a microcomputer program determines the wavelength of maximum constructive interference in the central region of the contact. In this case, the maximum constructive interference of spacer layer plus lubricant film occurs when:

$$n_{oil} h_{oil} + n_{sp} h_{sp} = \frac{(N - \phi) \lambda_{sp + oil}}{2 \cos \theta} \quad N = 1,2,3 \quad \text{Equation 4}$$

Maximum constructive interference of spacer layer occurs when:

$$n_{sp} h_{sp} = \frac{(N - \phi) \lambda_{sp}}{2 \cos \theta} \quad N = 1,2,3 \quad \text{Equation 5}$$

The lubricant film thickness is then calculated from the difference between the measured film thickness and the thickness of the silica spacer layer:

$$h_{oil} = \frac{(N_{sp + oil} \lambda_{sp + oil} - N_{sp} \lambda_{sp})}{2n_{oil}} \quad N = 1,2,3 \quad \text{Equation 6}$$

The ultrathin film technique incorporates two important advances over conventional optical interferometry. The first one is the use of a transparent silica spacer layer which acts like a supplementary oil film, enabling optical interference to be observed even when the actual oil film present is very thin. This overcomes a major limitation of conventional optical interferometry, that it cannot easily measure film below approximately one quarter the wavelength of visible light. Thus, lubricant films less than 100 nm (0.1 micron) thick cannot be measured using the conventional method. The second advance is that the reflected interfered light is dispersed by a spectrometer rather than being observed by the eye, as is done in

conventional optical interferometry. The dispersed spectrum is computer-analyzed to identify the wavelength of light that is most constructively interfered. This greatly increases the precision of the method compared to conventional optical interferometry.

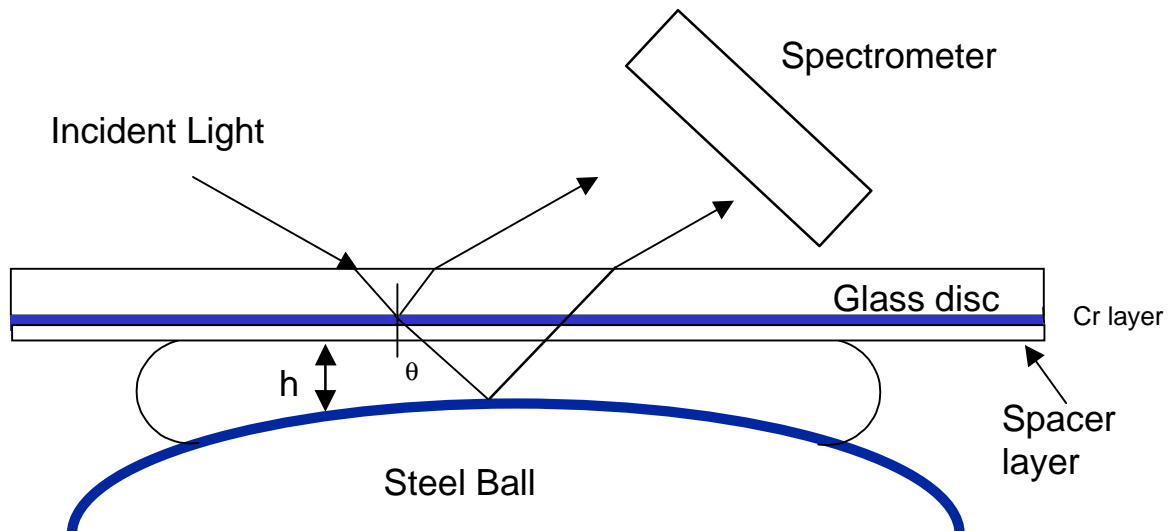

Figure 3. Principle of ultrathin film interferometry

Film Thickness Measurements for Lubricant/Refrigerant Mixtures – Pressurized Test Rig

The ultrathin film EHD rig was modified to operate at pressures above the vapor pressure of the refrigerants at the test temperatures. For this purpose, a new stainless steel test chamber with thicker walls (20 mm) was constructed. This chamber was fitted with a heavy section bolt-down lid with a nitrile O-ring and a small (25 mm diameter) fused silica insert to view the contact, as shown in Figure 4. The fused silica window was sealed with a nitrile O-ring and a copper washer to prevent stress cracking of the window due to misalignment. The optics were adjusted to compensate for the longer focal length as compared to the atmospheric system. The chamber was fitted with a new shaft and seal assembly. The seal assembly consisted of a high pressure bellows seal with graphite face. A solid-based chamber with no aperture for the load system was designed. A spring loading system with parallel leafs was fitted inside the chamber. When the ball and disc were placed and clamped in the chamber, the

springs deflected and applied a constant load of 20N to the contact. The chamber was fitted with heating rods, cooling galleries, an inlet valve, an adjustable pressure relief valve, and an emergency burst valve.

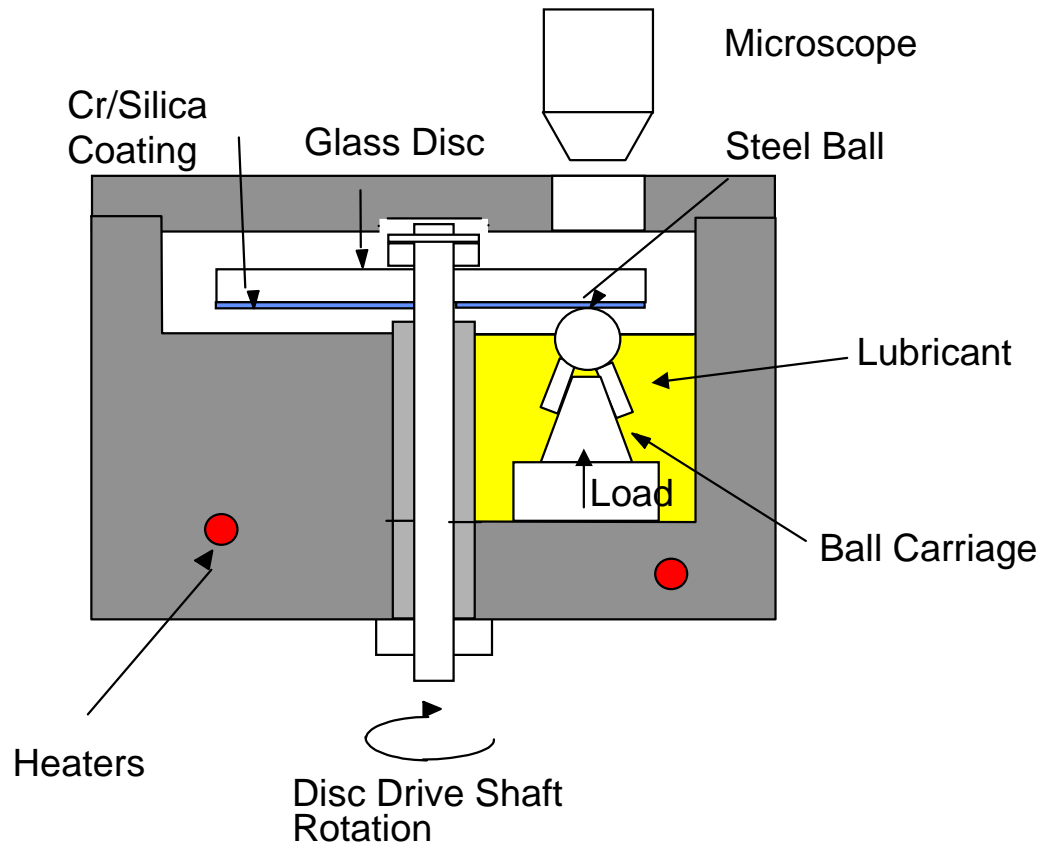

Figure 4. Pressurized Ultrathin Film Interferometry Rig

Figure 5 is a simplified diagram showing the test set-up for refrigerant/lubricant mixtures. The refrigerant cylinder was placed on a balance with a resolution of ± 0.05 g. The cylinder was connected to the test chamber by a 4.76 mm ID flexible stainless steel tubing. A known amount of refrigerant was introduced into the test chamber by a needle valve, V2. The system was designed to operate under 25 bars of pressure. The externally adjustable pressure relief valve was set at 35 bars. The emergency burst valve was rated at 50 bars. The system was fitted with vent and vacuum lines with needle valves for degassing the lubricant and discharging the refrigerant.

Test Procedure and Conditions

The test conditions are shown in Table 1. Film thicknesses of lubricants and refrigerant/lubricant mixtures were measured between the ball and the disc using ultrathin film interferometry as described above at a series of rolling speeds ranging from 0.01 m/s (2 rpm-disc rotational speed) to about 2 m/s (460 rpm). All of the tests were carried out at a load of 20N. For the glass-on-steel contact, this load resulted in a maximum Hertz contact pressure of 0.54 GPa.

Table 1. Test Conditions and Materials

Contact Materials	52100 steel ball (19 mm diameter) SiO ₂ coating (~ 400 nm) on Cr coated glass disc
Contact Load	20 N
Maximum Contact Pressure	0.54 GPa
Rolling Speed	0.01 to 2 m/s
Bulk Temperature	23 °C, 45 °C, 65 °C

The film thickness was measured at three fluid temperatures: ambient, 45 °C, and 65 °C. The ambient temperature varied from 22 °C to 25 °C between tests. The variation in the ambient temperature for each test was within ± 0.5 °C. The average temperature for each ambient temperature test was reported along with the data. The test temperature of 45 °C and 65 °C was controlled to a set value within ± 0.5 °C using a small K-type thermocouple with a resolution of 0.1 °C near the contact inlet. A new steel ball of RMS surface roughness of 11 nm was used for each test.

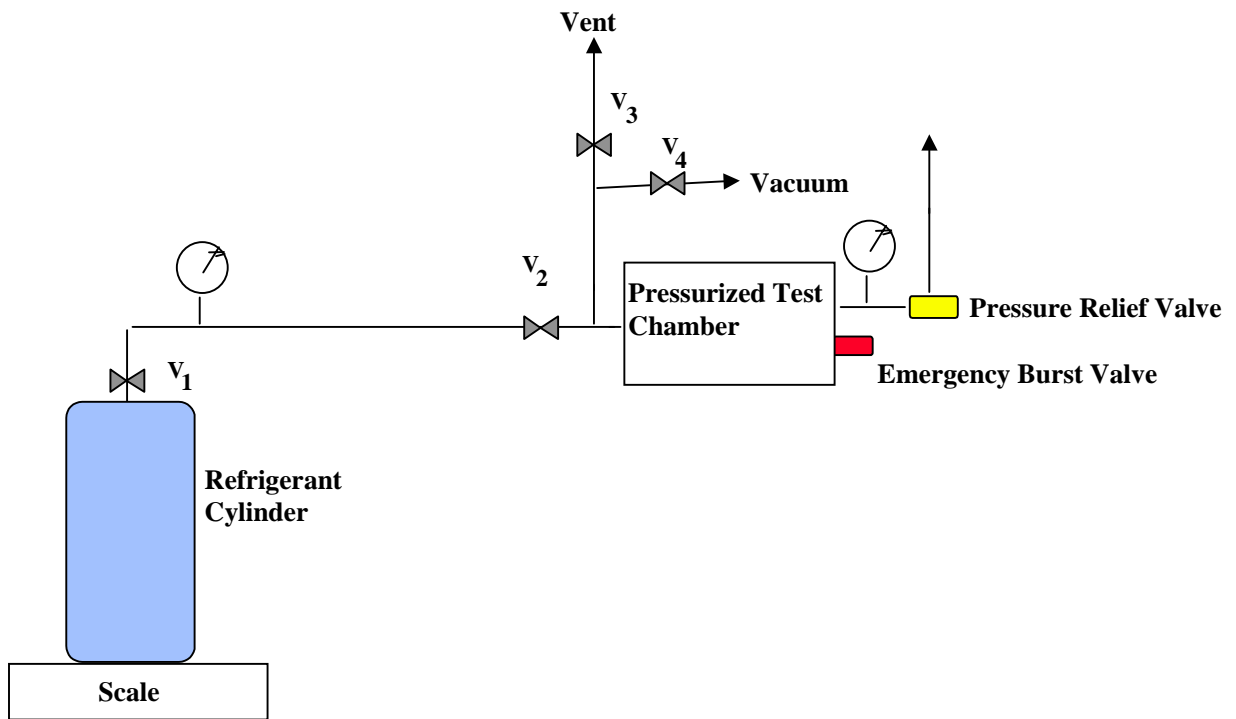

Figure 5. Pressurized Ultrathin Film Interferometry Rig

REFERENCES

1. Johnston, G. J., Wayte, R., and Spikes, H. A., "The Measurement and Study of Very Thin Lubricant Films in Concentrated Contacts", *Trib. Transactions*, 34, 2, 187, 1991.
2. Gonsel, S., Spikes H. A., and Aderin, M., "In-Situ Measurement of ZDDP Films in Concentrated Contacts", *Trib. Trans.*, 36, 2, 276, 1993.
3. Gonsel, S. and Spikes, H., "Film Formation Behavior of Lubricant Base Stocks in Concentrated Contacts", presented at the 1996 STLE Annual Meeting in Cincinnati, May 1996.
4. Casserly, E. and Gonsel, S., "Elastohydrodynamic Lubrication of Aluminum Cold Rolling Base Oils and Formulated Lubricants", presented at the 1996 STLE Annual Meeting in Cincinnati, May 1996.
5. Smeeth, M., Spikes, H. A., and Gonsel, S., "The Formation of Viscous Surface Films by Polymer Solutions: Boundary or Elastohydrodynamic Lubrication?", *Trib. Trans.*, 39, 237, 1996.
6. Smeeth, M., Spikes, H. A., and Gonsel, S., "Boundary Film Formation by Viscosity Index Improvers in Lubricated Contacts", presented at the STLE/ASME Tribology Conference, FL, October 1995, Preprint No. 95-TC-3C-1, accepted for publication in *Trib. Trans.*
7. Gonsel, S., Smeeth, M., and Spikes, H. A., "Friction and Wear Reduction by Boundary Film-Forming Viscosity Index Improvers", was presented at the 1996 SAE International Fall Fuels and Lubricants Meeting, October 1996, San Antonio, TX, accepted for publication by SAE, SAE 962037.
8. Smeeth, M., Spikes, H. A., and Gonsel, S., "The Performance of Viscosity Index Improvers in Lubricated Contacts", accepted for publication by *Langmuir*, September 1995.
9. Gonsel, S., "Elastohydrodynamic Lubrication Properties of Refrigeration Oils", presented at ASHRAE Meeting, Philadelphia, January 1997.

EHD Data for Suniso 3GS - 1st Run, Old Test Chamber
(Ambient Temperature = 24.3 ± 0.4°C)

Software version	2			
Lubricant name	Suniso 3GS			
Viscosity	0			
Oil refractive index	1.4954			
Spacer type	Silica			
Ball diameter	0.01905			
Disc track radius	0.044			
Trigger point	327			
Comments	Suniso 3GS IG07834 7/24/97			
Temperature=25	45	65°C		Load=20N
M.R.=0.141 Trig. Pt.=347				
Avg. Band Top=198 Bottom=341				
Spacer Layer Film Thickness=468.3				
R.I.25C=1.4954 45C=1.4887 65C=1.4814				
Disc #307				
Number of logged d	84			
Disc Speed (m/s)	Pot Temp (°C)	Lube Temp (°C)	Load (N)	Film (nm)
9.48E-03	24.21461	24.63446	20.0169	22.462972
9.50E-03	24.21461	24.64421	19.9675	22.765473
1.43E-02	24.21002	24.65884	20.27829	28.251532
1.43E-02	24.2192	24.67347	20.06218	27.982637
1.91E-02	24.19165	24.66859	20.11569	34.368365
1.91E-02	24.20084	24.66859	20.27006	34.906067
2.72E-02	24.20543	24.67347	20.22889	41.828827
2.73E-02	24.20543	24.65884	20.41516	41.963241
3.84E-02	24.20543	24.62958	20.21757	51.84202
3.85E-02	24.19625	24.62958	20.29784	51.506012
0.0547099	24.21002	24.63934	19.44472	63.130116
0.0547645	24.19165	24.64909	19.52499	64.944208
7.71E-02	24.19625	24.65884	20.07967	81.083742
0.0771085	24.21461	24.63934	19.56101	81.083742
7.72E-02	24.19165	24.63446	19.70714	81.133461
0.1077577	24.02176	24.41505	20.17023	99.68641
0.1078168	24.04472	24.4248	19.88414	99.417879
0.1078615	23.61312	23.85923	20.09717	100.9009
0.1080557	24.19625	24.64909	19.70302	101.23076
0.1080656	23.58097	23.85435	20.12495	101.03517
0.10819	24.25134	24.63446	20.02204	100.87029
0.1499979	23.64066	23.88848	19.96441	126.88189
0.1500341	23.64066	23.89823	20.26697	126.68049
0.2110866	23.62689	23.91773	19.56203	171.97348
0.2112421	23.65903	23.91286	19.50646	171.16848
0.2954289	23.67281	23.92261	19.89855	222.68611
0.2954306	23.67281	23.96162	19.86356	222.4104
0.4131691	23.69117	23.97137	20.48411	277.82065
0.4133033	23.70035	23.95674	20.18052	277.82065
0.5790405	23.71872	23.98599	19.85121	345.20083
0.5796881	23.70495	24.01525	20.12907	345.06312
0.8095279	23.7279	24.02012	20.21243	429.60478
0.810305	23.7325	24.025	19.47045	430.61364
1.133438	23.75545	24.09326	20.33798	538.31022
1.133745	23.75086	24.064	20.05292	538.31022

EHD Data for Suniso 3GS - 1st Run, Old Test Chamber
(Ambient Temperature = 24.3 ± 0.4°C)

1.584933	23.81055	24.16152	19.61864	660.13559
1.585949	23.80596	24.16152	19.39223	660.01924
slope=0.676				
9.46E-03	45.10627	44.82951	20.03336	6.4844858
9.53E-03	45.09708	44.80513	19.84813	6.4844858
1.44E-02	45.11086	44.92702	20.25565	8.8485073
1.91E-02	45.31289	45.1318	20.056	11.347509
1.91E-02	45.34044	45.11717	20.11363	11.347509
0.0271649	45.49196	45.1123	20.24742	15.805018
2.72E-02	45.42309	45.15618	20.07556	14.994573
3.85E-02	45.53328	45.14643	20.3884	19.789473
3.85E-02	45.55624	45.16593	20.00661	19.654376
5.46E-02	45.62971	45.19031	19.43237	25.124347
5.47E-02	45.59298	45.21956	20.1126	25.529471
7.70E-02	45.68021	45.16593	20.66729	32.619315
7.72E-02	45.66644	45.16106	19.53322	32.281755
0.1079355	45.81337	45.52673	20.17332	38.848394
0.1082008	45.96948	45.46822	19.4334	39.92854
0.1495543	46.00163	45.08792	20.35135	53.159649
0.1498794	46.01081	45.08792	20.44397	53.49715
0.2110779	46.04295	45.1123	20.61172	64.903374
0.2111915	46.05213	45.11717	19.94177	64.734658
0.2944353	46.11641	45.08305	19.66186	82.852377
0.2947544	46.08886	45.06354	20.2999	82.953569
0.4123819	46.20824	45.25369	19.4725	104.26548
0.4124573	46.21743	45.24882	20.05395	104.26548
0.5785002	46.30926	45.34145	19.99529	131.47468
0.5787191	46.32763	45.34633	19.84607	131.47468
0.8096434	45.91898	45.42532	20.33798	180.08518
0.8100432	45.85929	45.43019	20.11878	180.17754
1.134312	45.5241	45.43507	20.53659	226.72326
1.134622	45.49196	45.42532	19.53219	226.72326
1.58495	46.14856	46.2298	19.43546	283.10282
1.585322	46.14856	46.28831	20.7383	282.68763
slope=0.726				
0.0285279	63.34399	64.76671	20.38634	8.7191626
2.85E-02	63.27971	64.75655	20.06424	8.8209894
3.97E-02	63.57357	64.9038	19.72978	11.671571
3.97E-02	63.50011	64.87841	20.32871	11.400075
5.56E-02	63.76183	65.04597	19.53116	14.623819
5.57E-02	63.73887	65.04597	20.69404	14.725619
7.64E-02	64.04651	65.18306	19.93869	19.414081
7.64E-02	64.07406	65.15768	20.68067	19.074758
0.106605	64.3771	65.03581	20.76608	23.960738
0.106605	64.16129	64.76671	20.19699	23.349968
0.1496382	64.43679	65.08659	19.64436	29.049842

EHD Data for Suniso 3GS - 1st Run, Old Test Chamber
(Ambient Temperature = 24.3 ± 0.4°C)

0.1497304	64.47811	65.12721	19.71434	29.253392
0.2100993	64.5975	65.1983	19.52602	37.937937
0.2102182	64.63882	65.27953	19.97985	37.802273
0.2941449	64.83626	65.69081	20.19184	45.196825
0.294375	64.8684	65.75175	19.61246	45.128978
0.4129468	68.50951	66.12241	19.81211	55.092874
0.4131619	68.56002	66.13763	20.2824	55.160691
0.5789824	68.1881	66.20364	20.14656	70.216382
0.5789896	68.33044	66.38136	20.28858	70.216392
0.8099806	67.66926	65.89899	19.90987	90.033221
0.8103055	67.55447	66.04624	19.81314	89.82982
1.133404	67.155	65.97035	19.69479	111.73879
1.134405	67.18714	65.98051	19.7977	112.14539
1.134795	67.41672	66.5743	19.5466	113.68794
1.134795	67.41672	66.58446	20.12289	113.68794
1.585834	66.92542	66.89419	19.79152	142.90547
slope=0.678				

EHD Data for Suniso 3GS - 2nd Run, New Test Chamber
(Ambient Temperature = 22.6 ± 0.3°C)

Software version	2		
Lubricant name	Suniso 3GS		
Viscosity	0		
Oil refractive index	1.484		
Spacer type	Silica		
Ball diameter	0.01905		
Disc track radius	0.04387		
Trigger point	53		
Comments	Suniso 3GS 8/21/97		
Temperature=25	45 65°C Load=20N		
M.R.=0.139 Trig. Pt.=53			
Avg. Band Top=237 Bottom=322			
Spacer Layer Film Thickness=478.5			
R.I.25°C=1.4954 45°C=1.4887 65°C=1.4839			
Disc #307			
Number of logged data	150		
Disc Speed (m/s)	Pot Temp (°C)	Lube Temp (°C)	Film (nm)
9.44E-03	23.98503	22.70956	18.43172
9.54E-03	23.97126	22.71464	18.43172
1.44E-02	23.93912	22.70448	25.35697
1.44E-02	23.95748	22.70448	25.28973
1.91E-02	23.93912	22.70956	30.93699
1.91E-02	23.93452	22.69433	31.34034
1.91E-02	23.94371	22.6994	31.34034
2.72E-02	23.90697	22.74002	40.54966
2.72E-02	23.91157	22.72987	40.54967
0.0384478	23.88402	22.75526	49.69054
3.85E-02	23.91157	22.73495	50.09378
3.85E-02	23.8932	22.72987	50.09378
5.47E-02	23.91157	22.71464	63.73534
5.47E-02	23.91616	22.71971	64.8104
7.71E-02	23.90697	22.72987	82.61382
7.72E-02	23.92993	22.74002	82.54665
0.1077162	23.87943	22.78572	102.789
0.1077212	23.88402	22.79588	102.1846
0.1077558	23.86565	22.7908	102.7218
0.1077559	23.6223	22.35921	101.4971
0.1494366	23.84728	22.82126	129.1081
0.1494968	23.64526	22.35921	128.7783
0.1495376	23.84728	22.83142	129.8465
0.149664	23.61312	22.37444	128.0399
0.2106008	23.68199	22.38968	162.3449
0.2108509	23.66821	22.38968	162.2778
0.2939398	23.6774	22.43029	218.954
0.2940034	23.8381	22.84665	217.2892
0.2941594	23.66362	22.40491	217.2073
0.2942975	23.83351	22.84665	217.4272
0.2944044	23.68658	22.40491	216.7475
0.2945318	23.69117	22.39475	218.954
0.2946083	23.67281	22.42522	218.4331
0.4134945	23.82892	22.88727	273.4922
0.4138	23.69117	22.44553	276.1209

EHD Data for Suniso 3GS - 2nd Run, New Test Chamber
(Ambient Temperature = 22.6 ± 0.3°C)

0.4138715	23.6774	22.43029	275.3859
0.5777476	23.81055	22.94312	340.2657
0.5780187	23.69117	22.45568	347.8313
0.5781015	23.69117	22.46076	347.2478
0.8078063	23.78759	22.92789	422.5903
0.8082995	23.68658	22.4963	433.5797
0.8083633	23.70495	22.47599	433.5797
1.133642	23.70954	22.56739	547.9589
1.133653	23.71413	22.57247	547.8176
1.585634	23.7325	22.72987	667.4515
1.586508	23.72331	22.76541	667.0276
slope=0.701			
9.53E-03	45.15678	45.62975	6.357472
9.53E-03	45.01903	45.67037	6.86391
1.43E-02	45.11545	45.54851	8.78826
1.44E-02	45.12923	45.57898	8.78826
1.91E-02	43.60023	44.60382	11.67796
1.91E-02	43.69206	44.59367	11.91506
2.72E-02	44.9226	45.35556	14.35835
2.72E-02	44.38998	45.02018	14.82796
2.72E-02	44.29356	44.91862	15.03123
2.72E-02	44.5966	45.22328	14.52315
2.72E-02	44.9272	46.34541	14.35835
3.84E-02	44.165	44.68506	19.91095
3.85E-02	45.51951	45.00549	18.96247
5.45E-02	44.40835	44.71553	25.08803
5.45E-02	44.41753	44.71553	25.28973
7.70E-02	44.58742	44.84754	32.85292
7.70E-02	44.55069	44.7663	32.95378
0.1075118	44.77108	45.15727	40.41524
0.1076043	44.83077	45.23343	40.28079
0.1494102	44.91342	45.8732	50.29541
0.1495008	44.94097	46.01537	50.49699
0.2104653	44.96393	46.14231	64.00412
0.2104893	44.99148	46.10169	64.27288
0.2940416	45.07413	45.75642	80.53143
0.2940624	45.66644	46.02045	78.67514
0.2941052	45.5792	45.95952	78.87666
0.4132067	45.60216	45.21367	107.3131
0.413393	45.60216	45.21367	107.2207
0.5770403	44.8721	45.66021	131.1526
0.5774038	45.37813	45.39645	131.5543
0.5774238	45.45982	45.23397	131.7511
0.5778664	44.8721	45.68053	130.9678
0.5779969	45.3414	45.45231	131.4623
0.8074481	45.40472	45.15273	160.9879
0.8075681	45.37258	45.14766	161.0803
0.807672	44.78582	45.36599	160.1627
1.132671	44.93638	45.90901	200.514
1.132864	45.34044	45.31522	202.3585

EHD Data for Suniso 3GS - 2nd Run, New Test Chamber
(Ambient Temperature = 22.6 ± 0.3°C)

1.133146	44.9226	45.80746	200.9756
1.585293	45.15678	45.34568	263.1649
1.585355	45.04658	45.1375	256.1306
1.585565	45.14759	45.25936	263.5166
slope=0.707			
9.52E-03	61.2732	65.43688	3.797078
9.54E-03	61.38339	65.47242	4.101973
1.44E-02	61.25024	65.17793	4.813416
1.44E-02	61.36962	65.26424	4.915025
1.44E-02	61.42931	65.27948	5.016622
1.91E-02	60.72221	64.83266	6.16837
1.91E-02	60.72221	64.89359	6.236141
0.0191526	60.71302	64.87328	6.337742
2.72E-02	62.38436	66.12743	7.723639
2.72E-02	62.46241	66.12743	7.723639
0.0272139	62.32467	66.12234	7.79138
3.84E-02	61.83796	65.0256	10.1625
0.0384592	61.9252	65.09161	10.23026
3.85E-02	61.73235	64.93929	10.1625
5.46E-02	60.79108	64.59909	13.71906
5.46E-02	60.71762	64.58894	13.82068
7.71E-02	60.25387	64.53816	17.17377
7.71E-02	60.29519	64.58894	16.86895
7.71E-02	60.24468	64.54832	17.27542
0.1076693	60.07939	64.69048	21.47511
0.107673	60.1253	64.79204	21.54283
0.1078026	60.08398	64.71587	21.44124
0.1494554	60.80945	65.45211	26.35471
0.1494818	60.74057	65.39118	26.96427
0.1494906	60.19877	64.95451	26.96137
0.1495072	60.29519	65.04083	27.02905
0.1496733	60.31356	65.06622	26.41945
0.2105476	62.20988	66.30006	35.6521
0.2106533	62.18692	66.23405	35.78754
0.2941847	62.50374	66.2899	42.40474
0.2944185	62.26498	66.00048	43.01413
0.2945186	62.35221	66.11219	42.74327
0.4133403	60.94719	65.51305	53.39241
0.4134632	61.11708	65.71107	53.46012
0.4135951	61.10331	65.66537	53.39244
0.4135951	61.1079	65.67552	53.39244
0.5773893	60.57528	65.04083	66.86374
0.5777457	60.76353	65.36072	68.6236
0.5778404	60.69007	65.25916	68.6236
0.5778521	60.64874	65.2287	68.6236
0.5778642	60.76812	65.37595	68.58976
0.5780531	60.84159	65.45211	68.35287
0.5780531	60.85995	65.4775	68.35287
0.8072093	60.68089	65.07638	87.29949
0.8076695	60.64874	65.06622	87.43481

EHD Data for Suniso 3GS - 2nd Run, New Test Chamber
(Ambient Temperature = $22.6 \pm 0.3^{\circ}\text{C}$)

0.8077151	60.66711	65.05099	87.33332
1.131017	60.66711	65.13223	112.3994
1.132262	60.69925	65.03068	111.9259
1.132662	60.69925	65.06622	111.7681
1.58518	60.89669	65.33533	145.7825
1.585707	60.73139	65.17285	139.9922
1.585927	60.73139	65.14746	139.7893
1.586897	60.8875	65.35564	145.7825
slope=0.706			

EHD Data for Suniso 4GS - 1st Run, Old Test Chamber
(Ambient Temperature = 22.8 ± 0.5°C)

Software version	2			
Lubricant name	Suniso 4GS			
Viscosity	0			
Oil refractive index	1.484			
Spacer type	Silica			
Ball diameter	0.01905			
Disc track radius	0.043			
Trigger point	73			
Comments	Suniso 4GS IG07835 7/28/97			
Temperature=25	45	65°C		Load=20N
M.R.=0.144	Trig. Pt.=73			
Avg.Band Top=198	Bottom=341			
Spacer Layer Film Thickness=487.3				
R.I.25°C=1.498	45°C=1.491	65°C=1.4839		
Disc #307				
Number of logged data	125			
Disc Speed (m/s)	Pot Temp (°C)	Lube Temp (°C)	Load (N)	Film (nm)
0.0107924	23.7325	22.96851	19.74521	19.74521
1.09E-02	23.74168	22.9939	19.72669	19.72669
1.09E-02	23.70954	22.93805	19.68656	19.68656
1.40E-02	23.69117	22.90758	19.70405	19.70405
1.41E-02	23.70035	22.87712	19.69993	19.69993
2.03E-02	23.64526	22.82634	19.71125	19.71125
2.03E-02	23.68658	22.86696	19.86562	19.86562
2.03E-02	23.68199	22.86188	19.60835	19.60835
0.0280463	23.66362	22.81111	19.93148	19.93148
2.82E-02	23.65444	22.78572	19.78432	19.78432
3.92E-02	23.6223	22.76541	20.0488	20.0488
3.93E-02	23.64066	22.76541	20.2433	20.2433
5.50E-02	23.60393	22.7451	20.31842	20.31842
5.50E-02	23.59016	22.75526	20.56232	20.56232
5.50E-02	23.59934	22.7451	20.24124	20.24124
7.71E-02	23.55342	22.7451	20.3637	20.3637
7.71E-02	23.55802	22.75526	19.91193	19.91193
0.1067806	23.54424	22.80095	20.28858	20.28858
0.1070919	23.55342	22.76541	20.06115	20.06115
0.1495862	23.35599	22.40491	19.40973	19.40973
0.149706	23.33762	22.38968	19.4581	19.4581
0.2110249	23.35599	22.39475	20.2505	20.2505
0.2112934	23.38354	22.38968	19.47456	19.47456
0.2948141	23.36058	22.41506	20.52836	20.52836
0.2949439	23.39731	22.37952	20.65185	20.65185
0.4132107	23.39731	22.49122	20.17949	20.17949
0.413398	23.38813	22.50138	20.4131	20.4131
0.5789862	23.42027	22.55723	20.34209	20.34209
0.5790715	23.42945	22.53692	19.9603	19.9603
0.8108985	23.457	22.57754	20.49646	20.49646
0.8109908	23.45241	22.56231	20.20728	20.20728
1.133559	23.87943	23.16653	20.45015	20.45015
1.133918	23.48914	22.7451	20.71771	20.71771
1.1345	23.47078	22.72987	20.55306	20.55306
1.585119	23.8932	23.26301	20.17023	20.17023

EHD Data for Suniso 4GS - 1st Run, Old Test Chamber
(Ambient Temperature = 22.8 ± 0.5°C)

1.58535	23.88861	23.25285	20.09614	20.09614
1.585488	23.86565	23.26301	20.04983	20.04983
slope=0.687				
1.08E-02	44.99607	44.72033	19.66495	19.66495
1.08E-02	44.99607	44.53246	19.62275	19.62275
1.09E-02	45.00985	44.5477	19.90884	19.90884
1.40E-02	44.99148	44.84727	19.76065	19.76065
1.40E-02	44.99607	44.79649	19.72978	19.72978
2.03E-02	45.0328	44.9082	20.10128	20.10128
2.03E-02	45.02821	44.89804	19.9428	19.9428
2.81E-02	44.96852	45.13161	20.01381	20.01381
2.81E-02	44.95934	45.10622	19.77403	19.77403
3.92E-02	44.98689	45.157	20.4203	20.4203
3.92E-02	44.96852	45.13669	19.53734	19.53734
0.0549615	44.99148	45.20778	20.17229	20.17229
5.50E-02	44.99607	45.19254	19.58159	19.58159
7.70E-02	45.05117	45.18238	20.45221	20.45221
7.70E-02	45.08331	45.20778	19.95824	19.95824
0.1069362	44.46345	45.43118	20.34827	20.34827
0.1069416	45.07413	45.43118	20.44809	20.44809
0.1491589	45.45523	45.44134	19.65568	19.65568
0.1495145	45.43227	45.42103	19.58467	19.58467
0.210748	45.38635	45.27378	19.93457	19.93457
0.2108328	45.29452	45.21285	20.1939	20.1939
0.2944047	45.44145	45.54289	20.24227	20.24227
0.2946584	45.4139	45.54797	20.21757	20.21757
0.4129616	45.26238	45.34487	20.28755	20.28755
0.4133193	45.28075	45.39056	19.84607	19.84607
0.5782437	45.06495	45.14177	19.81211	19.81211
0.578272	45.09249	45.11638	20.2433	20.2433
0.809658	44.86751	45.06052	20.50881	20.50881
0.8098264	44.88128	45.07576	19.74419	19.74419
0.8102373	44.97311	45.14684	20.47485	20.47485
1.133028	44.79404	45.04529	20.47588	20.47588
1.133087	44.79863	45.09099	19.87077	19.87077
1.584202	44.59201	45.29409	19.75345	19.75345
1.584518	44.61038	45.2687	19.89238	19.89238
1.584741	44.63793	45.3144	20.18052	20.18052
slope=0.723				
2.03E-02	64.28527	64.94436	19.57335	19.57335
2.03E-02	64.3771	65.00529	20.01072	20.01072
2.82E-02	66.08517	65.02533	19.52396	19.52396
0.028255	66.27801	65.04057	19.85842	19.85842
3.91E-02	66.89328	65.14719	20.00352	20.00352
3.92E-02	66.75095	65.15227	19.67318	19.67318
5.49E-02	67.10449	65.08626	19.71743	19.71743
5.50E-02	67.09072	65.11672	19.85945	19.85945
7.71E-02	67.4259	65.17766	20.36679	20.36679

EHD Data for Suniso 4GS - 1st Run, Old Test Chamber
(Ambient Temperature = $22.8 \pm 0.5^{\circ}\text{C}$)

0.0770872	67.33408	65.08118	20.42236	20.42236
0.1070687	67.72895	64.69048	20.64053	20.64053
0.107259	67.87128	64.70572	20.3318	20.3318
0.1492749	65.04747	65.0713	19.41693	19.41693
0.149494	65.01992	65.17285	19.78844	19.78844
0.1495392	66.63156	65.2637	19.52087	19.52087
0.1495839	66.7739	65.2637	19.73184	19.73184
0.2111169	65.77753	65.1063	20.50057	20.50057
0.2112685	66.04843	65.08091	20.52836	20.52836
0.2943739	69.94668	65.43634	20.39252	20.39252
0.2943791	69.89617	65.42618	20.69404	20.69404
0.2945286	69.12479	64.67979	20.03542	20.03542
0.2948468	67.93098	64.76103	20.20214	20.20214
0.4127922	69.02377	65.38049	20.65185	20.65185
0.4129844	69.14315	65.36525	19.94383	19.94383
0.5782434	68.44982	65.53281	20.08173	20.08173
0.5785239	68.61971	65.56835	20.21448	20.21448
0.8098118	67.93557	65.70037	20.2505	20.2505
0.810335	68.05954	65.43126	19.87488	19.87488
1.133126	67.36163	65.79711	20.07556	20.07556
1.133289	67.43968	65.64986	19.42414	19.42414
1.58358	66.30556	65.60951	19.98602	19.98602
1.58408	66.68666	65.46227	20.48822	20.48822
slope=0.756				

EHD Data for Suniso 4GS - 2nd Run, New Test Chamber
(Ambient Temperature = 23.4 ± 0.4°C)

Software version	2		
Lubricant name	Suniso 4GS		
Viscosity	0		
Oil refractive index	1.498		
Spacer type	Silica		
Ball diameter	0.01905		
Disc track radius	0.0418		
Trigger point	19		
Comments	Suniso 4GS 8/22/97		
Temperature=25	45	65°C	Load=20N
M.R.=0.139	Trig. Pt.=19		
Avg. Band Top=234	Bottom=312		
Spacer Layer Film Thickness=478.7			
R.I.25°C=1.498	45°C=1.491	65°C=1.4839	
Disc #321			
Number of logged d:	135		
Disc Speed (m/s)	Pot Temp (°C)	Lube Temp (°C)	Film (nm)
1.06E-02	24.69673	23.52196	35.31589
0.0105919	24.7105	23.4915	34.91338
1.07E-02	24.71509	23.54227	35.11465
1.37E-02	24.70591	23.55243	41.62182
1.37E-02	24.69673	23.5575	41.65536
1.97E-02	24.70591	23.6032	53.92993
1.98E-02	24.68754	23.56766	53.96349
1.98E-02	24.71509	23.59305	53.62814
1.98E-02	24.69673	23.63367	54.43296
2.74E-02	24.67377	23.73522	68.46454
2.74E-02	24.66918	23.71491	68.46455
2.75E-02	24.65999	23.76568	67.25759
3.98E-02	24.67836	23.79107	86.36528
0.0397597	24.67836	23.77584	87.50488
5.50E-02	24.66459	23.80123	109.2873
5.51E-02	24.66459	23.79615	108.8182
7.65E-02	24.67377	23.81138	136.9578
7.66E-02	24.67377	23.87231	137.0248
0.1070188	24.71509	23.51181	185.2173
0.1072321	24.70591	23.52704	186.7318
0.1072462	24.69673	23.58797	170.1898
0.1073389	24.70591	23.52196	186.0892
0.1073461	24.71509	23.53719	187.2825
0.1074061	24.71509	23.53719	183.7028
0.150119	24.43501	23.01421	243.1719
0.1501563	24.49929	23.02436	243.2637
0.2099478	24.43041	23.01421	305.7403
0.2099548	24.41664	23.06499	306.886
0.2101039	24.42582	23.05991	306.1069
0.2941699	24.4396	23.07006	382.7987
0.2943983	24.43501	23.07006	383.0277
0.412468	24.45796	23.14115	484.5309
0.412502	24.46255	23.12592	484.1818
0.5780987	24.45337	23.17161	597.9326
0.5783198	24.45796	23.20716	598.0488
0.8081333	24.51765	23.42041	731.035

EHD Data for Suniso 4GS - 2nd Run, New Test Chamber
(Ambient Temperature = 23.4 ± 0.4°C)

0.8086671	24.44419	23.43564	730.7532
1.133461	24.52684	23.61336	894.6474
1.133463	24.53602	23.59812	894.7302
1.585873	24.5498	23.82154	1074.852
1.586061	24.55439	23.78599	1075.993
slope=0.686			
1.06E-02	43.82063	45.51777	12.28658
1.07E-02	43.80226	45.41114	12.08527
1.37E-02	43.65074	45.07095	14.60183
1.37E-02	43.72421	45.19789	14.16562
1.37E-02	43.58646	44.8577	14.70251
1.97E-02	43.40279	44.80692	18.32619
1.98E-02	43.41657	44.79676	18.12489
1.98E-02	43.4533	44.812	17.78937
2.74E-02	43.48544	44.84754	22.95628
2.75E-02	43.49004	44.86277	23.35887
2.75E-02	43.52677	44.80184	23.09047
3.97E-02	43.40279	44.95417	30.00133
3.97E-02	43.40739	44.87801	29.53169
0.0550779	43.42116	45.02018	38.15257
5.51E-02	43.44412	45.0151	37.98487
5.51E-02	43.43034	45.04556	38.11899
5.51E-02	43.44412	45.09634	38.05191
5.52E-02	43.41657	45.05064	38.65567
7.66E-02	43.43494	45.15727	47.24182
7.66E-02	43.42575	45.15727	47.57722
7.66E-02	43.42575	45.15219	47.71134
0.1071867	43.55891	44.7663	63.13375
0.1071939	43.41198	45.20805	59.8507
0.1071999	43.43494	45.21312	59.78365
0.1072054	43.54972	44.77138	63.26788
0.1072672	43.41198	45.28421	59.38128
0.1500722	43.76553	45.02525	79.04939
0.1501294	43.6186	44.94909	80.18911
0.1502293	43.63696	44.90847	79.71983
0.2097063	43.80226	45.19281	100.3319
0.2100118	43.82522	45.20805	100.0303
0.2100787	43.86654	45.29436	100.0303
0.2939947	43.93542	45.62948	125.2592
0.2941251	43.94001	45.65994	125.5607
0.4122334	44.1099	46.09661	159.4194
0.412329	44.05939	46.04583	158.9171
0.5778286	43.95378	45.86304	207.1995
0.5778953	43.92624	45.8275	207.3372
0.8078845	43.86654	45.80719	260.3155
0.8080969	43.88032	45.80719	260.0403
0.8081803	43.8344	45.81735	260.9575
1.133469	43.71961	45.79196	325.442
1.134058	43.71961	45.7818	325.5337
1.585578	43.62319	45.81227	411.0977
1.585997	43.6186	45.83258	410.9425

EHD Data for Suniso 4GS - 2nd Run, New Test Chamber
(Ambient Temperature = 23.4 ± 0.4°C)

1.586163	43.58646	45.83258	410.9812
slope=0.707			
1.06E-02	60.03806	64.76665	5.229474
1.06E-02	60.23091	65.04591	5.162351
1.37E-02	60.46967	65.25409	6.10202
1.37E-02	60.60742	65.4318	6.370491
1.97E-02	60.60742	65.30994	7.880548
1.97E-02	60.44671	65.15762	7.880552
1.98E-02	60.40998	65.10684	7.880551
2.74E-02	60.16204	64.71587	10.39734
2.75E-02	60.17581	64.72095	10.19601
2.75E-02	60.15285	64.73618	10.19594
3.97E-02	60.21714	64.85297	13.88705
3.97E-02	60.24009	64.92913	14.02125
5.51E-02	60.27223	65.07638	18.28248
5.51E-02	60.35947	65.18808	18.1483
0.0765157	60.55232	65.7263	22.97961
7.65E-02	60.59364	65.81261	23.48287
0.1071881	60.84159	66.23405	28.11251
0.1072233	60.79108	66.20866	28.31382
0.1500776	60.95638	66.57932	36.43175
0.1501024	60.98852	66.59963	36.36468
0.2097022	59.72584	64.73618	48.51624
0.2099751	59.75339	64.75141	48.44916
0.2941332	59.96919	64.67017	62.33194
0.2942247	59.84981	64.65495	62.06375
0.4121019	60.07939	64.77173	79.22875
0.4123204	60.02429	64.80219	79.29578
0.5777853	60.71762	65.33533	97.66275
0.5779001	60.66711	65.42165	97.59573
0.8077971	59.99674	64.62955	137.3758
0.8079274	61.12627	66.4473	133.2895
0.8085144	61.11249	66.42699	133.3813
0.8086897	60.02429	64.67525	137.3758
1.13316	60.03347	64.9799	169.7402
1.133798	60.07021	64.96975	169.7402
1.585878	60.35488	65.6806	213.2438
1.586765	60.39621	65.73645	213.1521
slope=0.747			

EHD Data for Emkarate RL32H - 1st Run, Old Test Chamber
(Ambient Temperature = 25.4 ± 0.2°C)

Software version	2			
Lubricant name	Emkarate RL 32H			
Viscosity	0			
Oil refractive index	1.451			
Spacer type	Silica			
Ball diameter	0.01905			
Disc track radius	0.04			
Trigger point	366			
Comments	Emkarate RL 32H IG08288 8/8/97			
Temperature=25	45	65°C	Load=20N	
M.R.=0.142	Trig. Pt.=336			
Avg. Band Top=202	Bottom=330			
Spacer Layer Film Thickness=491.3				
R.I.25°C=1.4510 45°C=1.4440 65°C=1.4370				
Disc #307				
Number of logged c	141			
Disc Speed (m/s)	Pot Temp (°C)	Lube Temp (°C)	Load (N)	Film (nm)
1.02E-02	26.30837	25.59359	20.30504	12.88846
1.02E-02	26.31296	25.60882	20.25153	12.95884
1.03E-02	26.32673	25.60374	20.04983	13.20515
1.46E-02	26.31296	25.57328	20.2505	17.00517
1.47E-02	26.29918	25.58343	20.2824	16.75885
1.47E-02	26.3451	25.5682	20.21963	17.53293
2.04E-02	26.33592	25.53774	20.28035	20.91962
2.04E-02	26.32214	25.53774	20.20111	20.28634
2.04E-02	26.33133	25.54789	20.34003	20.3567
2.78E-02	26.34051	25.52758	20.056	25.14137
2.78E-02	26.33592	25.50727	20.43368	25.56353
3.95E-02	26.33133	25.51235	19.75036	32.73977
3.95E-02	26.34051	25.50727	19.9994	33.7951
5.42E-02	26.33133	25.48696	19.69582	40.75952
5.43E-02	26.34051	25.49712	19.78432	41.18159
7.62E-02	26.32214	25.4565	19.96338	54.9585
7.62E-02	26.29918	25.42095	19.37783	54.60683
7.63E-02	26.35428	25.48696	19.39429	53.8423
0.1071485	26.36806	25.50727	20.24227	65.53147
0.1072035	26.34051	25.48696	19.84401	65.10956
0.151033	26.35888	25.49712	19.73287	79.52347
0.1511606	26.34051	25.50219	19.71949	79.45316
0.2109919	26.36347	25.52758	19.61452	103.0716
0.2110716	26.35888	25.50727	20.28858	103.0716
0.2947492	26.33133	25.65452	19.56306	132.5838
0.2950071	26.36347	25.60882	20.00558	132.092
0.4139853	26.33133	25.40572	19.72463	170.5235
0.4140497	26.34051	25.4108	20.28549	178.633
0.4141686	26.33592	25.37018	20.37399	178.9218
0.4141733	26.33133	25.43111	19.88826	170.4533
0.5782621	26.33592	25.34479	19.65465	221.7998
0.5785353	26.34051	25.32448	19.83681	221.6555

EHD Data for Emkarate RL32H - 1st Run, Old Test Chamber
(Ambient Temperature = 25.4 ± 0.2°C)

0.810121	26.33133	25.35495	19.67627	275.0454
0.8108404	26.32673	25.34987	20.31225	275.5263
1.134999	26.34051	25.28894	20.08379	341.4136
1.135157	26.35888	25.3194	20.16097	346.4989
1.135612	26.35888	25.27878	20.19493	341.5096
1.583252	26.58845	25.50727	19.33872	420.4728
1.586722	26.616	25.50219	19.62481	420.4728
1.587658	26.37265	25.34479	20.07453	421.4223
1.587866	26.36806	25.32956	19.83783	421.9107
slope=0.692				
1.02E-02	46.14856	45.31413	20.27726	6.125635
1.03E-02	46.35059	45.38014	20.21551	6.231238
1.03E-02	46.04873	45.40553	20.24433	5.914413
1.46E-02	44.9823	45.5477	20.37811	8.167379
1.47E-02	45.00066	45.57308	20.34209	8.026573
2.05E-02	45.01903	45.65432	20.27314	10.06827
2.05E-02	45.00525	45.68479	20.2752	10.03306
0.0205077	44.99148	45.77111	20.49337	10.56109
2.78E-02	44.97311	45.91328	20.14965	13.94032
0.0278058	44.99607	45.84219	20.25976	13.30674
2.78E-02	45.01443	45.81173	20.31842	13.30674
3.95E-02	45.00066	45.94374	19.77506	17.31941
3.95E-02	44.9777	45.94374	19.92016	16.68581
3.95E-02	45.00985	44.94882	20.37502	17.24902
5.43E-02	44.99607	44.91835	19.74727	21.54297
5.43E-02	44.96852	44.93359	19.67421	21.54298
5.43E-02	44.97311	44.92343	20.22066	21.22624
7.62E-02	44.96393	44.93866	19.74419	28.30022
7.63E-02	44.99148	44.89297	20.60451	28.08905
0.107005	45.00066	44.88281	19.88826	33.36774
0.1072015	44.99607	44.85743	20.23507	33.78998
0.1510043	44.99148	44.8625	20.15788	40.54599
0.151031	45.00985	44.85743	19.48794	40.26449
0.151051	44.99148	44.82188	19.64539	40.82746
0.1514577	45.00066	44.83712	20.18567	40.65155
0.2108713	45.06953	44.92851	19.58467	54.68921
0.2110416	45.07413	44.93359	19.9356	54.58369
0.2945543	45.01443	44.88281	20.33386	69.88474
0.2949098	45.05576	44.92851	20.00455	69.67371
0.4134692	45.40931	44.3144	20.17744	86.73234
0.4139062	45.4139	44.27886	19.84195	86.45105
0.5778406	45.27616	44.98436	19.80593	110.9199
0.5784388	45.27156	45.06052	20.54071	110.9199
0.8099698	45.22565	44.9996	19.44163	138.9648
0.8102422	45.19351	45.00975	19.60629	139.035
1.134514	45.10168	44.43626	19.89649	187.1748
1.134694	45.11086	45.27886	19.94383	177.2552

EHD Data for Emkarate RL32H - 1st Run, Old Test Chamber
(Ambient Temperature = 25.4 ± 0.2°C)

1.13532	45.12004	44.40072	20.32151	187.271
1.136002	45.08331	45.14177	20.41619	176.4826
1.58607	45.10627	45.32455	19.42928	229.2957
1.58749	45.0879	45.35502	20.00352	229.4401
slope=0.709				
1.03E-02	68.20647	64.72576	20.21757	3.793784
1.46E-02	64.9786	64.7156	20.00867	5.032817
2.05E-02	68.77361	64.69556	19.94074	6.382194
0.0277742	68.79419	64.3046	20.17435	7.317095
2.78E-02	70.38288	64.24366	19.76683	7.526973
2.78E-02	70.34926	64.42645	20.33386	7.251674
2.78E-02	71.25528	65.22843	20.15582	7.317099
3.96E-02	65.57091	64.91389	19.85121	10.04531
3.96E-02	66.08057	64.69556	19.88826	10.04531
3.96E-02	67.3754	64.46707	19.87077	10.14036
5.43E-02	66.84737	65.33052	19.83372	11.65418
5.43E-02	67.14123	65.46254	20.04365	11.49355
5.43E-02	65.62601	65.20332	19.80799	11.89898
7.63E-02	67.56365	65.65041	19.52293	14.99094
7.63E-02	67.66926	65.69102	20.44397	16.34065
0.1070854	67.89424	65.70118	19.81828	19.23164
0.1071498	68.05954	65.76719	19.88003	19.41817
0.1508881	68.36718	65.15308	19.90781	23.0551
0.1509629	68.39473	65.09723	20.12084	23.54466
0.1510791	68.38095	65.148	20.04674	23.36981
0.2111462	69.45997	65.03576	19.79358	29.25183
0.2113574	69.62527	65.02052	20.01175	29.25183
0.2944248	68.53247	65.26987	19.87385	38.80762
0.294862	69.71251	64.8885	19.92119	37.85264
0.2950696	69.67118	64.94436	20.18567	38.06241
0.4138598	69.82729	64.8225	20.02307	47.71075
0.413974	69.77679	64.89867	20.07556	47.50102
0.5787321	69.96045	64.55847	19.83886	62.18068
0.5788711	69.97882	64.59909	19.96647	62.18068
0.8108479	70.41961	64.72603	20.26903	78.21991
0.8109339	70.2084	64.76157	19.99014	78.11511
1.134938	71.32874	65.63998	19.9109	97.35659
1.136147	70.88336	65.05099	20.17744	99.35525
1.136493	70.71347	64.92405	19.72978	99.28535
1.587916	71.27824	66.12743	19.68038	122.6766
1.588334	71.28283	65.98525	19.98911	122.7813
slope=0.687				

EHD Data for Emkarate RL32H - 2nd Run, New Test Chamber
(Ambient Temperature = 22.5 ± 0.4°C)

Software version	2		
Lubricant name	Emkarate RL32H		
Viscosity	0		
Oil refractive index	1.437		
Spacer type	Silica		
Ball diameter	0.01905		
Disc track radius	0.04252		
Trigger point	340		
Comments	Emkarate RL32H 8/25/97		
Temperature=25	45	65°C Load=20N	
M.R.=0.141 Trig. Pt.=340			
Avg. Band Top=220 Bottom=294			
Spacer Layer Film Thickness=478.7			
R.I.25°C=1.4510 45°C=1.4440 65°C=1.4370			
Disc #321			
Number of logged data	131		
Disc Speed (m/s)	Pot Temp (°C)	Lube Temp (°C)	Film (nm)
1.07E-02	23.6223	22.29828	16.70887
1.08E-02	23.57179	22.24243	16.50103
1.08E-02	23.61771	22.29828	16.43174
1.08E-02	23.56261	22.25766	16.50103
1.39E-02	23.53047	22.21196	18.99504
1.39E-02	23.52128	22.21704	19.30679
1.39E-02	23.53965	22.21704	19.06434
0.0200095	23.63148	22.28812	24.81413
2.00E-02	23.84728	22.88219	25.22983
2.01E-02	23.65444	22.31351	25.36833
0.020069	23.86565	22.89235	24.60636
2.79E-02	23.53047	22.22212	31.25615
2.79E-02	23.54424	22.21704	31.6025
3.88E-02	23.51669	22.21704	40.19083
3.89E-02	23.52128	22.20688	39.98305
3.89E-02	23.5121	22.22212	41.02187
5.45E-02	23.50292	22.19673	49.88606
5.45E-02	23.49373	22.20181	49.55624
0.076287	23.47537	22.20181	64.30422
7.63E-02	23.47537	22.17642	64.30419
0.1074635	23.46618	22.16626	79.39503
0.1075119	23.46159	22.16626	79.53345
0.1075425	23.47078	22.17642	79.60266
0.1497064	23.64066	22.27797	98.08689
0.1497604	23.64066	22.25258	97.94849
0.2105144	23.65903	22.30336	123.8928
0.2105311	23.63607	22.27797	123.0627
0.2105731	23.66362	22.27797	123.6161
0.2947119	23.66362	22.26781	154.7371
0.2947956	23.63148	22.31351	154.3914
0.2948711	23.64985	22.27289	154.7025
0.4133843	23.68658	22.34905	206.2228
0.413455	23.68199	22.3846	206.1281
0.4137158	23.6774	22.35413	206.4123
0.5784506	23.68658	22.38968	256.14

EHD Data for Emkarate RL32H - 2nd Run, New Test Chamber
(Ambient Temperature = 22.5 ± 0.4°C)

0.5788258	23.70035	22.39475	256.3294
0.8081036	23.70954	22.51154	313.6321
0.8083928	23.67281	22.46584	313.6013
0.8084062	23.69576	22.39475	314.1692
0.8086654	23.69117	22.40998	313.6487
1.133099	23.71413	22.62324	384.3937
1.133331	23.71413	22.55723	385.5285
1.133691	23.70954	22.56739	386.1905
1.584603	23.7325	22.71464	476.663
1.586117	23.7279	22.70448	476.5429
slope=0.673			
1.07E-02	43.90787	45.75134	8.079831
1.08E-02	43.43494	45.32991	7.386582
1.08E-02	43.17321	44.95417	7.386582
1.08E-02	43.82063	45.72087	7.662115
1.08E-02	43.91246	45.72595	8.288733
1.08E-02	43.69206	45.63963	8.222054
1.39E-02	43.95837	46.00521	9.057529
1.39E-02	43.95837	45.95952	9.370844
0.0200439	44.05021	45.97475	11.77283
0.0200789	44.00429	45.97475	11.42473
2.78E-02	44.11449	45.94936	14.38358
2.79E-02	44.10071	45.94429	14.13992
3.88E-02	44.08694	45.72595	17.82956
3.88E-02	44.12826	45.74626	17.75996
5.45E-02	44.00429	45.61932	22.63286
5.45E-02	44.03643	45.64471	23.12012
7.62E-02	43.94001	45.50762	28.89739
7.63E-02	43.85277	45.45177	28.8278
0.1074403	43.52677	45.27913	36.62302
0.1074726	43.40279	45.14204	37.35378
0.1075205	43.71043	45.467	37.17978
0.1496955	43.11353	45.22836	44.34775
0.1498871	43.13189	45.25882	44.13895
0.2104347	43.1273	45.25374	57.01161
0.2107952	43.11812	45.30452	57.08118
0.2946366	43.17321	45.2639	71.8295
0.2946483	43.16862	45.24866	71.89906
0.413361	43.30178	45.24866	88.86951
0.4134802	43.22831	45.23343	88.79999
0.4136818	43.29259	45.23851	89.0086
0.5784273	43.72879	45.64979	109.7517
0.578749	43.69206	45.56347	109.8213
0.5792508	43.71961	45.65487	110.3079
0.5793368	43.71043	45.59901	110.3079
0.8082165	43.74257	45.80719	138.4584
0.8082678	43.76553	45.84274	138.111
0.8084934	43.74716	45.82243	138.3195
1.132737	43.77471	46.122	182.1705
1.132846	43.76094	46.122	183.0275

EHD Data for Emkarate RL32H - 2nd Run, New Test Chamber
(Ambient Temperature = 22.5 ± 0.4°C)

1.132914	43.77012	46.08138	182.3609
1.133494	43.77012	46.06615	182.6466
1.58393	43.86654	46.43681	221.9201
1.585094	43.88491	46.46219	222.2533
1.585147	43.89409	46.46727	222.7293
slope=-0.671			
0.0107772	60.04725	64.61432	4.131187
1.08E-02	60.00592	64.60925	4.131186
1.09E-02	60.02888	64.59401	4.655943
1.39E-02	60.45131	65.18301	4.760927
1.39E-02	60.33192	65.04591	5.180728
1.39E-02	60.2355	64.91389	4.760903
2.01E-02	61.11708	65.9751	6.230173
2.02E-02	61.20432	66.04111	5.915338
2.79E-02	62.3614	67.72684	7.769372
0.0279485	62.35681	67.70653	7.804376
3.89E-02	61.90224	66.70118	10.00822
3.89E-02	62.18233	67.05153	9.588445
5.44E-02	59.61564	63.9644	12.52682
5.44E-02	59.82226	64.04057	12.73664
7.62E-02	59.308	64.24366	16.19954
7.63E-02	59.30341	64.24874	16.0946
0.1075348	59.26209	64.56863	21.34111
0.1075643	59.28045	64.54832	21.20121
0.1496165	60.92883	65.97002	26.02762
0.2102567	60.10694	64.79711	32.7421
0.2105046	60.29519	65.17793	32.67215
0.294618	60.06561	64.61432	42.04335
0.294677	60.03806	64.51277	41.76364
0.4133728	60.07021	64.41122	53.44095
0.4135202	60.05643	64.42645	53.75558
0.5786946	60.16204	64.50262	67.00372
0.8081028	60.04725	64.40614	84.05815
0.8088281	60.09316	64.40107	83.84849
1.133245	60.46967	65.52827	102.7426
1.133276	60.52018	65.60444	102.6028
1.584913	60.62579	65.69583	128.1001
1.586422	60.66711	65.79739	127.6112
slope=0.689			

EHD Data for Emkarate RL68H - 1st Run, Old Test Chamber
(Ambient Temperature = 23.3 ± 0.3°C)

Software version	2			
Lubricant name	Emkarate RL68H			
Viscosity	0			
Oil refractive index	1.441			
Spacer type	Silica			
Ball diameter	0.01905			
Disc track radius	0.0395			
Trigger point	365			
Comments	Emkarate RL68H IG02920 8/11/97			
Temperature=25	45	65°C	Load=20N	
M.R.=0.145	Trig. Pt.=365			
Avg. Band Top=205	Bottom=341			
Spacer Layer Film Thickness=487.7				
R.I.25°C=1.4536 45°C=1.4468 65°C=1.4406				
Disc #307				
Number of logged c	151			
Disc Speed (m/s)	Pot Temp (°C)	Lube Temp (°C)	Load (N)	Film (nm)
1.00E-02	24.09064	23.31378	20.14656	24.8936
1.01E-02	24.09064	23.26301	20.2258	24.96274
1.01E-02	24.06768	23.29855	20.08791	24.96274
1.44E-02	24.07227	23.24778	20.25359	31.49422
1.44E-02	24.08146	23.26809	20.20419	31.45965
1.44E-02	24.07227	23.25793	20.22375	31.18321
2.01E-02	24.07227	23.26301	20.24021	38.85435
2.01E-02	24.07227	23.27824	20.29064	39.40718
2.02E-02	24.0585	23.2427	20.268	39.06167
2.74E-02	24.05391	23.23762	20.4203	49.21936
2.74E-02	24.02636	23.21223	20.07041	49.63394
2.75E-02	24.04931	23.22239	19.59394	49.21938
0.0389455	24.0034	23.18177	19.81725	65.43663
3.90E-02	24.03095	23.20208	20.2186	64.98762
3.91E-02	24.0034	23.16653	19.67318	64.71131
5.50E-02	23.98503	23.12592	20.19802	81.9098
5.50E-02	23.99422	23.13607	19.64436	81.70259
7.67E-02	23.95289	23.09037	19.67627	104.3616
0.0767461	23.95748	23.07514	19.78432	105.052
7.68E-02	23.99422	23.10053	20.62407	104.4892
0.1071004	23.93452	23.04975	20.4203	126.3127
0.1071655	23.92993	23.05991	20.39664	126.8648
0.107204	23.96207	23.04467	19.96133	126.7268
0.1504581	24.15033	23.17161	19.15142	161.4419
0.1505582	24.13655	23.16653	19.87694	161.9622
0.1506046	24.13196	23.18685	19.69479	161.5365
0.2096002	24.1136	23.19192	20.79387	213.3542
0.2098664	24.15492	23.197	20.27623	213.3542
0.2102605	24.15492	23.21223	20.15891	214.5831
0.2954338	24.17329	23.2427	19.76374	269.1402
0.2957606	24.1641	23.22746	20.10849	268.9512
0.4130721	24.1687	23.22746	19.56306	336.0993
0.4132186	24.1641	23.26809	19.4725	335.7217

EHD Data for Emkarate RL68H - 1st Run, Old Test Chamber
(Ambient Temperature = 23.3 ± 0.3°C)

0.5784324	24.20084	23.25793	19.71434	418.3269
0.5784761	24.18706	23.26301	20.0488	417.6665
0.5785754	24.22839	23.28332	20.02925	419.5702
0.8095101	24.26512	23.38487	19.39635	512.7579
0.8095269	24.26512	23.37979	19.92428	512.4383
0.8100072	24.23298	23.33917	19.62378	512.7579
0.8104607	24.26053	23.34933	19.81725	512.9976
1.134905	24.29726	23.51181	19.62481	624.4083
1.135044	24.28808	23.4915	20.72286	624.9896
1.584583	24.33399	23.65398	20.36473	722.2523
1.586079	24.32481	23.59812	20.17332	710.1668
1.586163	24.32022	23.6032	19.43031	710.312
slope=0.665				
1.00E-02	48.26986	45.28421	20.06012	11.41924
1.00E-02	48.42598	45.2639	20.17332	11.93996
0.0100665	48.15507	45.2639	20.21243	11.80112
1.44E-02	48.45811	45.19281	20.26388	14.64772
1.44E-02	48.49026	45.16235	20.14965	14.85599
1.45E-02	48.44893	45.15727	20.28343	14.64772
2.02E-02	48.60964	45.16742	20.28755	17.91074
2.02E-02	48.71065	45.22328	20.3318	17.98018
2.03E-02	48.65555	45.19789	20.28652	17.7719
2.74E-02	48.71065	45.23343	20.27314	21.59014
2.75E-02	48.66474	45.23851	19.71949	21.00004
3.90E-02	48.91727	45.32991	19.71949	27.76829
3.90E-02	48.84381	45.36037	20.162	27.97657
3.90E-02	48.85758	45.35529	20.03954	27.98656
3.90E-02	48.87595	45.41622	20.19699	27.76831
5.49E-02	49.1193	45.52285	20.43265	32.97415
5.50E-02	49.09634	45.49746	19.99014	34.0153
5.50E-02	49.00911	45.52285	19.81622	33.73769
7.67E-02	49.32592	45.52285	19.77506	43.03779
0.0767768	49.47744	45.5127	20.39355	42.3238
0.1071281	49.73457	45.41114	20.29064	53.89784
0.1071406	49.92283	45.31975	20.62304	53.37746
0.1504224	49.78049	45.1268	20.14142	67.42094
0.1505459	54.44094	45.85797	20.20934	67.38651
0.1505459	54.4042	45.84274	19.63613	67.38651
0.1506071	49.85395	45.11665	19.91193	67.14346
0.2098413	53.93586	45.45177	20.48822	86.32187
0.210048	54.10116	45.57363	19.42002	86.46066
0.2953582	54.83581	45.39591	19.94589	110.8384
0.2955044	54.64296	45.32483	20.32151	110.769
0.4126848	54.89091	45.46219	19.67112	147.0135
0.4130182	54.6057	45.38095	20.09202	147.1085
0.5781549	54.18477	45.43173	19.76683	184.4578
0.5783809	54.15263	45.36064	20.20111	185.0279
0.810217	54.70266	45.65514	20.19184	226.3522

EHD Data for Emkarate RL68H - 1st Run, Old Test Chamber
(Ambient Temperature = 23.3 ± 0.3°C)

0.8104922	54.57409	45.67545	20.12701	226.2573
1.134712	52.23698	45.46781	20.16714	267.5095
1.135601	52.25994	45.45258	19.74316	267.6044
1.585882	51.32326	45.45285	20.12186	318.8555
1.586537	51.25898	45.32084	20.18979	318.1913
slope=0.671				
0.0100091	66.95757	64.91389	20.05497	5.989218
1.00E-02	66.96216	64.84789	20.12392	5.989218
1.01E-02	67.00348	64.6651	20.08585	5.846694
1.01E-02	66.99889	64.67525	20.07041	5.567631
0.014415	66.97593	65.12688	20.20419	7.520954
0.0144392	67.00348	64.52688	20.23918	7.451195
0.0144435	66.97134	64.54211	20.09305	7.698206
2.02E-02	66.96216	64.98498	19.95412	9.756276
2.02E-02	67.00807	65.15227	20.31534	9.990721
2.02E-02	66.96216	65.02533	20.13113	9.573915
2.74E-02	67.00807	65.2589	20.08379	12.90834
2.74E-02	66.98052	65.29951	20.37296	12.80414
3.90E-02	67.00348	64.59401	19.64436	16.24264
3.90E-02	67.00348	64.54324	20.19905	16.38158
3.90E-02	66.99429	64.64479	19.56615	16.03426
3.90E-02	66.99429	64.57851	20.19081	15.89176
3.91E-02	66.98971	64.61405	19.63613	15.6825
5.50E-02	67.09531	65.33025	19.67318	20.21929
5.50E-02	66.97593	65.66483	19.71846	19.86754
5.50E-02	66.99429	65.65975	20.56952	20.07676
7.67E-02	66.97593	65.59374	19.85636	25.72618
7.67E-02	66.96216	65.69556	19.36033	26.03622
7.68E-02	66.99429	65.62421	19.8471	25.72619
7.69E-02	66.97134	65.71079	19.88003	26.03622
0.1070973	66.98052	65.42618	19.94589	29.49221
0.1071571	66.97593	65.32971	19.81108	30.32907
0.1505762	67.04939	65.73056	20.03645	39.83245
0.1508112	67.02644	65.72548	19.77917	39.62328
0.2098928	66.97134	65.73564	19.36959	51.54582
0.2099303	67.00807	65.68994	19.65465	50.98807
0.210008	66.99889	65.69502	19.9428	50.91837
0.210048	67.02184	65.70517	19.50132	52.1733
0.2955418	66.92083	64.9692	20.01896	67.85748
0.29566	66.92542	64.89812	20.0488	67.54382
0.4131548	66.90247	64.7001	20.51189	82.84124
0.4131839	66.93461	64.81688	19.70405	82.91093
0.5781228	66.98971	64.563	19.5538	106.2057
0.5782177	66.86573	64.48176	20.08482	108.0973
0.5785316	67.03562	64.63917	19.94898	106.5191
0.5788796	66.89328	64.6087	19.94177	107.7838
0.8102477	66.96216	65.33451	19.8615	134.97
0.8108832	67.03562	65.42083	19.46324	135.0397

EHD Data for Emkarate RL68H - 1st Run, Old Test Chamber
(Ambient Temperature = $23.3 \pm 0.3^\circ\text{C}$)

1.136047	66.81522	65.89304	19.7092	173.8161
1.136165	67.19633	64.53789	19.61864	175.4952
1.136516	67.12745	65.44141	20.06732	175.8769
1.136645	66.85196	65.71025	19.67935	174.0945
1.588695	67.2101	65.64959	19.88517	216.2329
1.588969	67.22847	65.49219	19.52087	216.2329
slope=0.707				

EHD Data for Emkarate RL68H - 2nd Run, New Test Chamber
(Ambient Temperature = 22.5 ± 0.3°C)

Software version	2		
Lubricant name	Emkarate RL68H		
Viscosity	0		
Oil refractive index	1.454		
Spacer type	Silica		
Ball diameter	0.01905		
Disc track radius	0.04327		
Trigger point	231		
Comments	Emkarate RL68H 8/26/97		
Temperature=25	45	65°C Load=20N	
M.R.=0.145 Trig. Pt.=231			
Avg. Band Top=230 Bottom=308			
Spacer Layer Film Thickness=480.0			
R.I.25°C=1.4536 45°C=1.4468 65°C=1.4406			
Disc #321			
Number of logged data	128		
Disc Speed (m/s)	Pot Temp (°C)	Lube Temp (°C)	Film (nm)
9.38E-03	23.59475	22.25766	27.37882
9.49E-03	23.58097	22.26274	27.79357
1.42E-02	23.57638	22.25258	36.19177
1.42E-02	23.5672	22.26274	36.08811
1.42E-02	23.59475	22.25258	35.88075
2.04E-02	23.55802	22.24243	47.99
2.05E-02	23.55802	22.2475	47.02251
2.05E-02	23.58097	22.26781	46.88435
2.84E-02	23.52128	22.22719	58.66576
2.85E-02	23.56261	22.25258	58.49303
3.96E-02	23.53506	22.2475	72.37934
3.96E-02	23.53965	22.2475	72.65565
5.55E-02	23.54424	22.22719	91.09719
5.55E-02	23.54883	22.23735	91.51159
7.61E-02	23.52128	22.23735	114.9188
7.61E-02	23.53047	22.23735	114.9188
7.61E-02	23.53047	22.25258	115.264
0.107743	23.5121	22.22212	147.2207
0.1078059	23.52588	22.22212	146.9447
0.1078654	23.5121	22.2475	147.2897
0.1507028	23.59475	22.29828	194.4303
0.150831	23.6223	22.27797	194.4303
0.1508387	23.61771	22.27797	194.4303
0.2111795	23.60852	22.28812	247.841
0.2111816	23.62689	22.28812	248.03
0.2954032	23.60852	22.31859	306.0623
0.295409	23.64526	22.29828	305.3068
0.412846	23.64066	22.35921	384.078
0.4129144	23.63148	22.35413	384.2667
0.5781675	23.66362	22.45061	478.2896
0.5783492	23.64985	22.44553	478.8889
0.8079553	23.66362	22.57247	594.0966
0.8086889	23.68658	22.58262	593.079
0.8088514	23.67281	22.57247	593.8058
1.132052	23.70035	22.61308	713.5338

EHD Data for Emkarate RL68H - 2nd Run, New Test Chamber
(Ambient Temperature = 22.5 ± 0.3°C)

1.13323	23.6774	22.59785	713.0981
1.585511	23.69576	22.85173	819.2136
1.587407	23.7325	22.85173	820.0673
slope=0.676			
9.32E-03	43.84818	45.19789	12.54996
9.40E-03	43.79767	45.14711	12.10053
1.42E-02	44.12367	45.31467	16.38712
1.42E-02	44.1053	45.35529	16.04142
2.04E-02	44.0548	45.09634	21.15736
2.04E-02	44.10071	45.2182	20.53515
2.04E-02	44.1099	45.24359	20.74253
2.84E-02	43.93542	45.05572	26.342
0.0283837	43.98592	45.07095	25.78897
2.84E-02	44.02266	45.05064	25.67377
3.95E-02	43.88032	44.99987	32.56306
3.95E-02	43.8895	45.04556	32.56304
5.53E-02	43.79767	44.90847	39.61288
5.54E-02	43.82522	44.9694	39.71658
7.59E-02	43.76553	44.74599	51.43012
7.59E-02	43.7793	44.82723	50.60091
0.1077428	43.76094	44.77645	64.14349
0.1078811	43.75634	44.7663	63.24537
0.1506201	43.72421	45.0151	79.35746
0.1507265	43.71043	45.05064	79.56466
0.2109732	43.68288	45.03541	99.76515
0.2109856	43.69666	45.01002	99.31631
0.2949826	43.65533	44.95925	124.8728
0.2950236	43.68288	44.99479	126.3105
0.2951988	43.63237	44.92878	125.425
0.2953795	43.69666	45.0151	126.1724
0.4126687	43.66911	44.98463	159.3092
0.4127588	43.65533	44.98971	158.2053
0.4127761	43.65992	44.97448	159.2403
0.577804	43.76553	45.1268	205.8855
0.5779199	43.76553	45.15219	206.1692
0.8079955	43.76094	45.30959	253.053
0.8082023	43.78389	45.32991	253.1002
1.132	43.83899	45.77165	324.7095
1.132385	43.83899	45.77673	324.3495
1.586836	43.82981	45.86812	391.5466
1.586836	43.81144	45.85797	391.5466
1.587629	43.81604	45.88335	391.4866
slope=0.676			
9.41E-03	60.81863	65.03576	6.907382
9.43E-03	61.36044	65.48257	6.838238
9.49E-03	60.41916	64.66002	6.384266
1.41E-02	60.19418	64.6194	9.184613
1.42E-02	60.15744	64.46707	8.216607

EHD Data for Emkarate RL68H - 2nd Run, New Test Chamber
(Ambient Temperature = 22.5 ± 0.3°C)

1.42E-02	60.17122	64.50769	8.354875
2.05E-02	61.90683	65.87862	10.49832
2.05E-02	60.87832	64.79204	10.63657
2.84E-02	60.08857	64.15227	14.05898
2.84E-02	60.21254	64.20812	13.67873
2.84E-02	60.52018	64.39091	13.88616
3.95E-02	62.73332	66.85858	17.27387
0.0395601	60.24468	64.89867	17.48131
3.96E-02	60.17122	64.74634	16.65166
0.0553786	61.20432	64.87835	21.83664
5.54E-02	61.36962	64.95959	21.76751
5.54E-02	61.99407	65.61459	21.62929
7.60E-02	60.47886	64.3706	28.26551
7.60E-02	60.94719	64.72095	27.98902
7.60E-02	60.51559	64.88583	28.05813
0.1077947	60.03347	64.8706	35.31581
0.1077992	59.9646	64.35537	35.21214
0.1505358	61.42013	65.90401	41.12141
0.1505784	60.35029	65.32517	41.35719
0.1508009	61.50737	66.03603	41.39783
0.21089	61.67266	65.59963	51.76368
0.2109082	61.90224	65.86874	52.82863
0.2109732	60.30897	65.37595	53.03594
0.210978	61.92979	65.89413	52.82863
0.2109793	61.60838	65.54378	51.90187
0.2110423	60.2906	65.37595	52.96684
0.2110777	61.5992	65.55901	51.90187
0.2949158	60.24009	65.12715	66.6125
0.295132	60.27223	65.1627	66.71615
0.4125181	60.20336	64.94436	84.60675
0.4129212	60.20795	64.9799	84.53767
0.5772402	60.22632	64.74634	107.7401
0.5777097	60.24468	64.74634	107.464
0.808148	60.19418	64.76665	135.9044
0.8086642	60.19418	64.75649	136.2149
1.132073	60.29978	65.00021	170.2668
1.132278	60.37325	65.08653	170.2668
1.586453	60.81404	65.76692	219.2096
1.586847	60.81863	65.78723	219.2096
1.587045	60.86455	65.93955	218.5007
slope=0.679			

EHD Data for Mobil EAL Arctic 68 - 1st Run
(Ambient Temperature = 22.5 ± 0.5°C)

Software version	2		
Lubricant name	Mobil EAL Arctic 68		
Viscosity	0		
Oil refractive index	1.438		
Spacer type	Silica		
Ball diameter	0.01905		
Disc track radius	0.04392		
Trigger point	369		
Comments	Mobil EAL Arctic 68 IG0 9/2/97		
Temperature=25	45	65°C Load=20N	
M.R.=0.139 Trig. Pt.=369			
Avg. Band Top=234 Bottom=315			
Spacer Layer Film Thickness=483.7			
R.I.25°C=1.4516 45°C=1.4445 65°C=1.4384			
Disc #327			
Number of logged data	133		
Disc Speed (m/s)	Pot Temp (°C)	Lube Temp (°C)	Film (nm)
9.44E-03	23.50751	22.21196	30.33567
9.47E-03	23.48455	22.17642	30.26643
9.50E-03	23.47996	22.1815	30.02418
1.43E-02	23.457	22.19165	40.71692
1.44E-02	23.47537	22.18657	41.13213
1.90E-02	23.43863	22.17134	50.68142
1.90E-02	23.43404	22.15103	49.92029
1.91E-02	23.45241	22.15611	49.64352
2.71E-02	23.42486	22.15611	64.39965
0.0271388	23.43863	22.16626	64.67634
2.71E-02	23.41109	22.15611	63.84617
0.0384363	23.37894	22.14088	80.86214
3.84E-02	23.41109	22.14088	81.20792
5.46E-02	23.39731	22.16119	102.1607
5.46E-02	23.38813	22.15103	101.2964
5.46E-02	23.4019	22.16119	102.9904
7.71E-02	23.39272	22.15611	132.2305
7.72E-02	23.37435	22.15611	132.6107
0.1077874	23.53047	22.25258	178.8489
0.1077877	23.54883	22.21704	178.47
0.1078874	23.53047	22.22212	178.8488
0.149712	23.59016	22.27797	220.5083
0.1497263	23.55802	22.25766	219.9403
0.1497541	23.57638	22.27797	220.5083
0.2107499	23.58097	22.27797	286.5678
0.2108762	23.58557	22.30843	287.2891
0.2946983	23.59475	22.35921	351.2304
0.2946986	23.61771	22.30843	352.3119
0.2948452	23.61312	22.32367	352.7925
0.4121517	23.62689	22.36936	436.1884
0.4126439	23.63607	22.3846	435.7081
0.4126685	23.63148	22.40491	435.588
0.5778348	23.65903	22.51661	540.4653
0.5786648	23.64066	22.52169	540.7652
0.8084177	23.65444	22.57754	674.5956
0.8093742	23.63607	22.54708	674.8138

EHD Data for Mobil EAL Arctic 68 - 1st Run
(Ambient Temperature = 22.5 ± 0.5°C)

0.809382	23.66821	22.53692	674.8865
1.133274	23.75545	22.90758	816.095
1.133524	23.7279	22.85173	819.0016
1.133626	23.74627	22.88219	818.3177
1.585917	23.74627	23.01421	986.2396
1.586243	23.76464	23.04467	984.668
slope=0.692			
9.47E-03	43.32014	45.41114	11.30871
9.48E-03	43.14567	45.13696	10.97244
9.51E-03	43.32474	45.39591	11.34347
1.44E-02	43.51299	45.55839	15.51746
1.44E-02	43.57268	45.61932	15.58702
1.44E-02	43.53595	45.5787	15.48267
1.91E-02	43.6186	45.42638	18.99555
1.91E-02	43.5084	45.31467	18.92595
2.71E-02	42.99414	44.80692	24.50711
2.71E-02	43.22831	44.82723	24.02025
0.0271868	43.16403	44.84754	24.50711
3.84E-02	45.75368	46.82777	32.36642
3.84E-02	45.65726	46.44188	32.22735
5.46E-02	43.51758	45.35022	39.44482
5.46E-02	43.51299	45.29944	38.81897
7.70E-02	43.59105	45.35022	50.50075
7.70E-02	43.45789	45.31975	49.87497
7.71E-02	43.47167	45.29436	49.87497
7.71E-02	43.58646	45.29944	50.36168
0.1076717	43.39361	45.41622	64.47454
0.1077428	43.49004	45.27913	65.20121
0.1077772	43.41657	45.36037	64.26598
0.1078287	43.53136	45.30959	64.29752
0.149661	43.13189	45.01002	82.22985
0.1496958	43.56809	45.40607	81.25689
0.1497314	43.57727	45.41622	81.1874
0.2106041	43.40279	45.55839	101.0292
0.210802	43.59564	45.49239	101.0607
0.2108278	43.49004	45.43145	101.1996
0.2108299	43.60482	45.50762	101.1996
0.2945128	43.47626	45.45177	130.3046
0.294615	43.6186	45.58378	129.1239
0.2946633	43.60023	45.52285	129.8878
0.2946812	43.46249	45.467	130.6865
0.4121988	43.6186	45.60409	163.0773
0.4122241	43.62319	45.61932	163.1467
0.4123245	43.48085	45.46192	163.355
0.5779672	43.38443	45.40099	217.9805
0.5782933	43.37984	45.40607	217.8378
0.8088743	43.39361	45.44161	271.5187
0.8092417	43.35688	45.44161	271.4712
1.132252	43.34311	45.47715	344.595
1.132776	43.38902	45.63456	343.7497
1.133	43.36147	45.65994	343.7497

EHD Data for Mobil EAL Arctic 68 - 1st Run
(Ambient Temperature = 22.5 ± 0.5°C)

1.584256	43.43494	45.83258	420.1825
1.585281	43.42575	45.82243	420.3031
1.585339	43.43034	45.79196	419.9411
slope=0.706			
9.46E-03	60.50181	65.31502	6.087145
9.46E-03	60.39161	65.13223	6.087145
9.51E-03	60.29978	65.00529	6.01722
1.43E-02	61.57165	66.39146	7.97472
1.44E-02	60.69007	65.46735	8.044627
1.44E-02	60.91046	65.67552	7.97472
1.91E-02	61.74154	66.47777	10.21181
1.91E-02	61.69562	66.40161	10.4914
2.71E-02	61.47982	65.6806	13.63722
2.72E-02	61.61297	66.06649	13.77702
3.83E-02	61.18137	64.90882	17.20222
3.84E-02	61.28697	65.06114	17.41194
0.0545739	61.00229	64.81235	22.44459
5.46E-02	61.06657	64.81235	22.09513
7.70E-02	60.90128	64.80219	28.31563
7.71E-02	60.89669	64.80727	28.31563
0.1076695	60.77731	64.92405	36.91157
0.1076755	60.78649	64.90882	36.63203
0.1495686	60.22173	65.40642	44.45826
0.1497376	60.21714	65.33025	44.24863
0.2107825	60.21714	65.17793	56.61514
0.2107909	60.35947	65.22363	55.56723
0.2108672	60.19877	65.2287	56.40555
0.2947842	60.50181	65.09161	71.28433
0.2948115	60.57987	65.12207	71.42401
0.4120421	60.65792	65.28455	87.86749
0.4120899	60.65792	65.27948	87.65802
0.5779403	60.57987	65.23378	111.9544
0.578267	60.59824	65.23378	111.745
0.8079073	60.64415	65.65521	140.848
0.8091171	60.63037	65.63998	140.7782
0.8091717	60.64415	65.67045	140.6387
1.132053	60.65792	65.77708	186.6785
1.132226	60.60283	65.72122	186.4394
1.132682	60.66252	65.71614	186.8219
1.132737	60.67629	65.76692	186.8219
1.585705	60.63956	65.86847	229.5534
1.586156	60.64874	65.90909	229.5534
1.58637	60.63037	65.84308	230.0311
1.586924	60.64874	65.86339	230.1267
slope=0.705			

EHD Data for Mobil EAL Arctic 68 - 2nd Run
(Ambient Temperature = 23.5 ± 0.5°C)

Software version	2		
Lubricant name	Mobil EAL Arctic 68		
Viscosity	0		
Oil refractive index	1.452		
Spacer type	Silica		
Ball diameter	0.01905		
Disc track radius	0.04417		
Trigger point	30		
Comments	Mobil EAL Arctic 68 IG08946 9/4/97		
Temperature=Amb	45	65°C	Load=20N
M.R.=0.136 Trig. Pt.=30			
Avg. Band Top=223 Bottom=305			
Spacer Layer Film Thickness=470.9			
R.I.25°C=1.4516 45°C=1.4445 65°C=1.4384			
Disc #321			
Number of logged c	125		
Disc Speed (m/s)	Pot Temp (°C)	Lube Temp (°C)	Film (nm)
9.68E-03	24.41664	23.0396	29.22738
9.68E-03	24.40746	23.02436	28.81201
9.72E-03	24.38909	23.0396	28.74277
0.0145586	24.41664	23.0396	38.98774
1.46E-02	24.43041	23.02944	38.43402
1.46E-02	24.42123	23.02944	38.88394
1.93E-02	24.41664	23.05991	47.29337
1.93E-02	24.43501	23.0396	46.8781
2.75E-02	24.41664	23.05991	60.5803
2.75E-02	24.40286	23.04975	60.78785
2.75E-02	24.42582	23.05483	61.6182
3.88E-02	24.42123	23.07006	78.07541
3.88E-02	24.42582	23.07514	78.45589
3.88E-02	24.5452	23.66413	76.91
5.51E-02	24.42582	23.04975	100.3124
5.51E-02	24.43501	23.06499	100.3816
5.51E-02	24.41205	23.10053	101.4189
7.60E-02	24.43501	23.09037	124.236
7.61E-02	24.4396	23.08529	125.1347
7.61E-02	24.4396	23.07514	124.7891
0.1067976	24.42123	23.09037	156.7896
0.1068944	24.41664	23.07006	156.8933
0.1069044	24.43041	23.1056	156.306
0.1506283	24.43501	23.08022	212.6014
0.1507146	24.40286	23.08022	213.1695
0.2105697	24.41205	23.07514	266.3646
0.2105755	24.41664	23.07514	266.128
0.2948636	24.42123	23.1056	337.3585
0.2949057	24.40746	23.10053	338.6805
0.2950921	24.39827	23.09545	338.0795
0.4132377	24.41205	23.12592	422.4235
0.413264	24.41205	23.12084	421.7029
0.5785536	24.41205	23.18177	526.336
0.5785732	24.41205	23.19192	526.4816
0.8088694	24.41664	23.25793	648.548

EHD Data for Mobil EAL Arctic 68 - 2nd Run
(Ambient Temperature = 23.5 ± 0.5°C)

0.8090619	24.39368	23.23254	649.4036
0.8091998	24.40286	23.23762	647.8635
1.132968	24.44419	23.41026	795.9603
1.133166	24.43501	23.4458	793.6008
1.13338	24.4396	23.40518	795.3704
1.584904	24.46715	23.78091	944.7989
1.585471	24.49929	23.85708	941.262
1.585529	24.53143	23.90277	939.7883
1.586303	24.4947	23.77584	943.8164
slope=0.697			
9.67E-03	43.61401	45.13696	11.63395
9.71E-03	43.57727	45.11665	11.77242
9.76E-03	43.58187	45.15219	11.53007
1.46E-02	43.50381	44.97448	15.58071
1.46E-02	43.49922	44.90339	16.06544
1.46E-02	43.53595	44.94909	15.58071
1.93E-02	43.64615	44.96432	19.83893
1.94E-02	43.65074	44.97956	19.83893
2.75E-02	43.72421	45.05064	24.71996
2.75E-02	43.78849	45.12173	24.71996
3.88E-02	43.89409	45.26897	32.19662
0.0388563	43.87572	45.22836	31.85048
5.51E-02	44.82159	46.08646	40.77993
5.51E-02	44.84455	46.07122	41.12602
7.60E-02	44.82159	45.77165	50.88473
7.61E-02	44.83996	45.86304	51.29994
7.61E-02	44.82618	45.79704	51.09235
0.1069162	43.93542	44.5632	67.36262
0.1070575	43.9446	44.55812	67.29343
0.1504369	44.06857	44.71045	85.14185
0.1505143	44.12367	44.83739	85.28016
0.2103445	44.24305	45.13696	105.8207
0.2103741	44.36702	45.25374	106.5122
0.2104974	44.36243	45.27913	106.5122
0.2947533	44.69762	45.83766	131.6943
0.2948549	44.66088	45.78688	131.3487
0.4130888	43.55432	45.13188	173.3858
0.4133335	43.5635	45.15727	173.7646
0.578731	43.54972	45.18266	216.473
0.5789081	43.58646	45.15727	216.0943
0.8083444	43.63237	45.25374	268.3415
0.8088329	43.6186	45.29436	268.2469
1.132317	43.69206	45.55839	339.2918
1.132683	43.70584	45.69549	338.4104
1.133239	43.68288	45.56855	339.1716
1.585388	43.73798	45.8275	413.7258
1.586497	43.73339	45.80211	415.1071
1.586648	43.72879	45.73611	415.7076
slope=0.704			

EHD Data for Mobil EAL Arctic 68 - 2nd Run
(Ambient Temperature = 23.5 ± 0.5°C)

9.67E-03	60.5615	65.40134	5.540164
9.76E-03	60.62579	65.43688	5.505527
9.76E-03	60.63497	65.45719	5.505527
1.46E-02	59.92786	64.72095	7.75612
1.46E-02	60.01051	64.76665	7.790732
1.46E-02	59.90491	64.70572	8.10236
1.93E-02	60.08857	64.85297	9.7643
1.93E-02	60.01051	64.86312	9.418076
0.0275175	60.17581	64.93929	12.6726
2.75E-02	60.24928	65.06114	12.88034
3.88E-02	61.55787	65.87354	16.6194
3.89E-02	61.78745	66.26452	16.20392
5.51E-02	61.13545	65.05607	21.08522
5.51E-02	60.85536	64.74634	20.98129
5.51E-02	60.74057	64.66002	20.77358
7.60E-02	60.25846	64.47215	27.31608
7.61E-02	60.26305	64.49246	27.3507
0.1069889	59.5284	64.45692	35.24241
0.1506184	60.24928	65.50288	43.82532
0.1507349	60.18959	65.3201	43.41006
0.2106107	60.15744	65.29979	54.8293
0.2106147	60.15285	65.21347	54.8293
0.2948618	60.22173	64.91898	69.29092
0.2952561	60.21714	64.9342	69.36012
0.4129167	60.30897	64.95451	88.86797
0.4130776	60.33652	64.9342	88.66043
0.5780783	60.54773	65.23885	122.4962
0.5781807	60.48344	65.17793	122.5909
0.5783951	60.44671	65.17285	122.6856
0.8080534	60.69466	65.58413	148.796
0.8080689	60.60742	65.56382	148.7486
0.8084144	61.82878	65.27494	144.2959
0.8085377	60.67629	65.57397	148.6539
1.132634	60.53395	65.34548	183.4645
1.132634	60.52477	65.34548	183.4645
1.132856	60.49263	65.26424	183.8907
1.133249	60.49263	65.24393	183.8907
1.585222	60.49263	65.27948	227.7781
1.5855	60.48804	65.26933	227.8254
1.585561	60.48344	65.31502	227.8254
slope=0.729			

EHD Data for CPI Solest 68 - 1st Run
(Ambient Temperature = 23.2 ± 0.4°C)

Software version	2		
Lubricant name	CPI Solest 68		
Viscosity	0		
Oil refractive index	1.44		
Spacer type	Silica		
Ball diameter	0.01905		
Disc track radius	0.04463		
Trigger point	404		
Comments	CPI Solest 68 IG08617 9/10/97		
Temperature=Ambi	45	65°C	Load=20N
M.R.=0.137 Trig. Pt.=404			
Avg. Band Top=223 Bottom=305			
Spacer Layer Film Thickness=461.9			
R.I.25°C=1.4531 45°C=1.4465 65°C=1.4396			
Disc #327			
Number of logged d	136		
Disc Speed (m/s)	Pot Temp (°C)	Lube Temp (°C)	Film (nm)
9.78E-03	24.29726	22.87204	31.84295
9.78E-03	24.30185	22.85173	31.9467
9.84E-03	24.31562	22.86188	32.05045
9.85E-03	24.30644	22.87712	31.53155
9.87E-03	24.30185	22.86188	31.49698
1.47E-02	24.29267	22.86188	41.49369
0.0147474	24.29267	22.85681	41.805
1.49E-02	24.29726	22.84157	41.805
1.96E-02	24.29267	22.84157	49.89818
1.96E-02	24.30185	22.86696	50.10565
1.96E-02	24.29267	22.84157	49.89818
2.78E-02	24.31103	22.84665	64.62949
2.79E-02	24.28808	22.82634	63.59217
3.93E-02	24.28808	22.84665	82.91043
3.93E-02	24.29267	22.84665	82.42648
3.93E-02	24.30644	22.86188	82.84128
0.0540058	24.2743	22.85681	102.1271
5.41E-02	24.29726	22.83142	102.1962
7.69E-02	24.28808	22.84665	129.1458
0.0768966	24.2743	22.85173	129.0766
0.1081266	24.30644	22.87204	162.0947
0.1081352	24.28808	22.86696	161.9566
0.108137	24.30185	22.89235	161.9566
0.1505505	24.29726	22.9025	211.3765
0.1505906	24.30185	22.88219	213.0798
0.1506013	24.29726	22.9025	213.5529
0.1506554	24.29726	22.9025	212.0389
0.2111422	24.29267	22.88727	266.8581
0.2112503	24.30644	22.89235	268.4185
0.2113629	24.29726	22.88219	267.2837
0.2943811	24.30185	22.91266	341.0342
0.2947012	24.29267	22.92281	341.0342
0.2947047	24.31103	22.87712	340.4937
0.4125434	24.30185	22.95836	423.0797
0.4126734	24.29726	22.96343	423.0197
0.578209	24.30644	23.01929	520.5422
0.5783867	24.32022	22.95836	521.0819

EHD Data for CPI Solest 68 - 1st Run
(Ambient Temperature = 23.2 ± 0.4°C)

0.8082492	24.33399	23.1513	645.958
0.8089687	24.3294	23.16146	645.616
1.130935	24.33858	23.30871	774.9996
1.131301	24.36154	23.37979	772.3843
1.131691	24.35695	23.33917	774.4185
1.585747	24.39368	23.50165	923.0991
1.586766	24.36613	23.40518	923.8676
slope=0.680			
9.87E-03	44.32111	45.92397	13.48979
9.87E-03	44.00888	45.42638	13.48977
9.87E-03	44.26601	45.84274	13.42033
1.47E-02	44.46345	45.95444	17.2422
1.48E-02	44.51395	46.01029	17.45064
1.48E-02	44.48182	45.9189	17.10323
1.96E-02	44.51395	45.79196	20.78595
1.96E-02	43.72421	44.95417	20.99439
1.96E-02	44.56905	45.99506	20.92493
2.77E-02	44.38539	45.3756	27.66446
2.78E-02	44.45427	45.61932	27.73397
2.79E-02	44.44967	45.51777	28.18555
3.93E-02	44.32111	45.22836	35.16769
3.93E-02	44.22928	45.05572	35.16772
3.93E-02	44.27519	45.14204	35.37611
5.40E-02	44.00888	45.05572	43.50359
5.40E-02	44.13285	45.04049	44.75386
5.41E-02	44.0548	45.03541	44.1982
5.41E-02	44.165	45.03033	44.47606
7.69E-02	43.79308	44.92878	55.33211
7.70E-02	43.77012	44.88816	55.12375
0.1078329	43.65992	44.80692	71.68559
0.1081391	43.70125	44.80184	71.9286
0.1505545	43.72879	44.83231	87.56287
0.1505574	43.77012	44.73584	87.2021
0.1505588	43.72421	44.90847	86.9034
0.1505664	43.74716	44.88308	86.72984
0.1505784	43.75175	44.7663	86.99385
0.1507404	43.73798	44.85262	87.11167
0.2110281	43.73798	44.75107	111.4591
0.211135	43.73339	44.78153	110.7305
0.2111604	43.72879	44.75615	111.9795
0.2111631	43.71043	44.75107	110.5223
0.2945347	43.84818	44.74599	137.0949
0.2945929	43.81604	44.65459	139.2453
0.2946257	43.80226	44.70029	139.0372
0.4126318	44.18795	45.24359	183.3492
0.412699	44.19714	45.25882	183.4442
0.5779327	44.23387	45.37053	228.1052
0.5779848	44.22928	45.36037	227.9627
0.8085551	44.35784	45.98998	279.8174
0.8090324	44.37162	46.00014	280.2922
1.131596	44.39457	46.0763	344.4556
1.131596	44.33029	46.09153	344.4556

EHD Data for CPI Solest 68 - 1st Run
(Ambient Temperature = 23.2 ± 0.4°C)

1.584428	44.35325	46.30987	425.0568
1.585384	44.35784	46.25909	425.0568
1.585386	44.36243	46.30987	424.876
1.585477	44.34407	46.28955	425.0568
slope=0.687			
9.77E-03	61.20432	65.03068	7.927365
9.83E-03	61.05739	64.86312	7.579875
9.85E-03	61.13086	64.95451	7.406131
1.48E-02	61.31911	65.03576	10.01218
1.48E-02	61.47063	65.25409	10.22064
1.95E-02	61.63134	65.3201	11.61052
1.96E-02	61.76908	65.45719	11.67999
1.96E-02	61.69562	65.35056	11.67999
2.78E-02	62.08131	65.65521	14.91133
2.78E-02	62.21906	65.80246	15.08505
0.0392019	62.56802	65.93955	19.91441
3.92E-02	62.4716	65.78723	20.15759
3.93E-02	62.41191	65.60444	19.60167
0.0539754	62.37518	65.69076	24.60443
5.40E-02	62.38436	65.72122	24.81284
0.054091	62.37518	65.70091	24.70865
7.68E-02	62.51751	65.85831	31.69106
7.69E-02	62.43027	65.87862	31.69105
7.69E-02	62.50374	65.86339	31.62158
7.69E-02	62.43946	65.85323	31.89947
0.1079507	62.59098	65.94971	39.19381
0.1080529	62.58639	65.94971	39.4022
0.1506402	61.00689	64.92913	50.4464
0.1507766	61.01607	65.00529	50.23804
0.2111415	60.97015	64.95959	63.50266
0.2113264	60.97474	64.99006	63.46794
0.294312	60.99311	64.60416	78.67393
0.2946648	61.83337	65.117	76.7419
0.2947166	60.98393	64.51277	78.50036
0.4123317	61.55328	65.00021	96.55252
0.4123346	61.26402	65.29471	94.32061
0.4126621	61.60838	65.09161	96.62225
0.5778242	61.06657	64.64986	129.1986
0.5779801	61.07576	64.69556	129.4852
0.8087355	61.27779	64.90882	157.8592
0.8088432	61.28238	64.96975	157.8592
1.131315	61.48441	65.42673	193.2468
1.131621	61.48441	65.44196	193.1035
1.131757	61.39717	65.21347	194.2495
1.13181	61.41094	65.25409	194.3927
1.584729	61.73235	66.32037	235.338
1.584917	61.72776	66.34068	235.0517
1.585519	61.75072	66.36098	234.8608
1.586178	61.78745	66.46254	233.9062
slope=0.682			

EHD Data for CPI Solest 68 - 2nd Run
(Ambient Temperature = 22.2 ± 0.5°C)

Software version	2		
Lubricant name	CPI Solest 68		
Viscosity	0		
Oil refractive index	1.44		
Spacer type	Silica		
Ball diameter	0.01905		
Disc track radius	0.04168		
Trigger point	328		
Comments	CPI Solest 68 IG08617 9/12/97		
Temperature=Ambe	45	65°C	Load=20N
M.R.=0.14 Trig. Pt.=368			
Avg. Band Top=223 Bottom=301			
Spacer Layer Film Thickness=480.4			
R.I.25°C=1.4531 45°C=1.4465 65°C=1.4396			
Disc #321			
Number of logged d	130		
Disc Speed (m/s)	Pot Temp (°C)	Lube Temp (°C)	Film (nm)
1.06E-02	22.85091	21.7296	29.89663
1.07E-02	22.81418	21.74483	30.51915
1.07E-02	22.80959	21.71944	29.89663
1.37E-02	22.83255	21.72452	37.05537
1.38E-02	22.82796	21.73975	36.88245
1.38E-02	22.83714	21.70421	36.74412
1.98E-02	22.83255	21.70929	48.36245
1.98E-02	22.80959	21.71437	48.01668
0.0198718	22.81877	21.69913	47.94757
2.75E-02	22.80041	21.70929	60.96766
2.75E-02	22.80041	21.7296	61.58989
3.98E-02	22.79122	21.71437	79.56319
0.039777	22.79581	21.70421	80.32348
3.98E-02	22.80041	21.71437	80.87645
5.51E-02	22.79581	21.70421	99.81201
0.055077	22.79581	21.71437	100.3648
5.51E-02	22.77745	21.70929	99.32829
7.65E-02	22.87846	21.76006	127.0315
7.65E-02	22.78663	21.70929	127.7223
7.65E-02	22.78204	21.70421	128.1367
0.107167	22.86928	21.78545	158.3837
0.1071804	22.87387	21.7753	158.0384
0.1073104	22.8601	21.76006	158.3146
0.1499733	22.88765	21.80068	212.2717
0.1500472	22.90601	21.77022	212.65
0.1500732	22.90601	21.81591	213.0285
0.1501772	22.88765	21.78037	212.5554
0.2111558	22.9106	21.82099	271.9961
0.2112732	22.89683	21.81591	271.9961
0.211353	22.88765	21.80576	271.429
0.2950471	22.91979	21.85146	352.459
0.2954148	22.92897	21.8413	351.9787
0.4131571	22.92438	21.85146	438.2885
0.4131824	22.92897	21.87684	438.5285
0.4133504	22.93815	21.87684	439.9684
0.5782659	22.99325	22.03425	545.8476

EHD Data for CPI Solest 68 - 2nd Run
(Ambient Temperature = 22.2 ± 0.5°C)

0.5785863	22.9657	21.98855	546.9308
0.5786399	22.97948	22.01394	545.4838
0.5786607	22.97489	21.97332	546.6721
0.8091111	23.01621	22.17642	666.9083
0.8097613	23.01162	22.12057	669.2344
0.8099148	22.98866	22.14088	669.2344
1.134153	23.06672	22.41506	803.2952
1.134214	23.06672	22.40491	804.235
1.135101	23.05294	22.3846	804.0641
1.586671	23.10345	22.56739	961.1011
1.586931	23.09886	22.56739	960.6102
1.587033	23.12641	22.66894	958.5486
1.588104	23.11722	22.65371	958.5486
slope=0.703			
0.0106066	43.71043	44.87293	12.23593
1.06E-02	43.68747	44.88816	12.23593
1.07E-02	43.67829	44.85262	12.02754
1.37E-02	44.75272	45.87828	14.9454
1.38E-02	44.38539	45.65994	15.15378
1.98E-02	44.44049	45.67517	19.53039
1.98E-02	44.40376	45.63963	19.39144
1.98E-02	44.4359	45.70057	19.18306
2.74E-02	44.44967	45.60409	25.05276
0.0274484	44.42672	45.58886	25.22641
2.75E-02	44.4359	45.60409	25.15696
3.97E-02	44.40376	45.35529	32.72784
3.97E-02	44.34407	45.32483	33.0751
3.97E-02	44.37621	45.34514	33.7002
3.98E-02	44.31192	45.28421	33.7002
5.50E-02	44.20173	45.16235	41.33955
5.50E-02	44.12367	45.05572	41.61739
5.50E-02	44.10071	45.0151	41.20071
7.64E-02	44.04562	44.85262	53.49135
7.64E-02	43.95837	44.88816	53.42191
7.64E-02	43.9997	44.91862	53.07478
0.1068046	43.81144	44.82215	68.27884
0.1070435	43.82063	44.82215	68.00117
0.14976	43.88032	44.85262	85.21456
0.1498888	43.87114	44.85262	85.56161
0.2110576	43.70125	44.812	107.1415
0.2110703	43.75175	44.78661	106.4477
0.2111104	43.71502	44.80184	107.1068
0.2950362	43.92164	44.88308	142.2459
0.2951466	43.92164	44.89832	142.1508
0.4125261	44.01807	45.23851	178.9341
0.4130974	44.0548	45.24359	179.2192
0.5782137	44.11449	45.22836	223.2562
0.5784982	44.17418	45.25374	222.8288
0.578736	44.12826	45.18266	223.2562
0.8093918	44.34407	46.02045	274.0424
0.8095457	44.3257	45.96967	274.0424

EHD Data for CPI Solest 68 - 2nd Run
(Ambient Temperature = 22.2 ± 0.5°C)

1.133382	44.36243	46.34033	335.5408
1.133611	44.36243	46.33525	335.6357
1.133629	44.37162	46.2794	336.2523
1.133863	44.37621	46.27432	336.6792
1.586116	44.30733	46.45204	417.3169
1.586532	44.34407	46.47235	418.5221
1.586773	44.31192	46.43681	417.317
1.587051	44.30733	46.45712	417.4977
1.587216	44.31652	46.46219	419.1247
slope=0.705			
0.1068332	61.1079	64.76157	37.79951
0.1069144	61.14004	64.79204	37.97397
0.0762554	61.31452	64.79711	29.63404
7.63E-02	61.31911	64.80727	29.63404
5.50E-02	61.49818	64.85297	23.45687
5.50E-02	61.55787	64.83773	23.14281
3.97E-02	61.78745	65.08653	18.01224
3.97E-02	61.88388	65.18808	17.80286
2.74E-02	62.53129	66.37114	13.6143
2.74E-02	60.97015	64.69048	13.19545
2.75E-02	60.91505	64.65495	13.50962
2.75E-02	60.91046	64.63463	13.54451
1.98E-02	61.31452	65.117	10.68219
1.98E-02	61.3788	65.29979	10.36806
1.37E-02	61.53032	65.70091	7.959473
1.06E-02	61.18137	65.06114	7.121666
1.06E-02	61.38799	65.24901	6.702769
0.1499492	61.90224	65.6349	47.1154
0.1498748	61.89765	65.7466	46.90606
0.2110226	61.90683	66.11726	59.67402
0.2109936	61.90224	66.13758	59.60427
0.2951525	61.91602	66.41684	75.36912
0.2952025	61.91143	66.37114	75.36912
0.4128703	61.95275	65.50797	92.83251
0.4129112	61.96652	65.50797	92.69305
0.57784	62.0859	65.10176	116.467
0.5779943	62.11345	65.10176	116.2579
0.8098556	60.90128	64.54324	157.7489
0.8089555	60.90128	64.55339	157.7489
1.133614	60.82322	64.61432	196.1382
1.133569	60.81863	64.64986	196.1382
1.133814	60.81863	64.72603	196.1382
1.586561	60.85536	64.9342	241.0977
1.587227	60.88291	65.01037	241.0977
1.587227	60.88291	65.01037	241.0977
slope=0.714			

EHD Data for Idemitsu Kosan FVC32B - 1st run
(Ambient Temperature = 22.8 ± 0.2°C)

Software version	2		
Lubricant name	FVC32B		
Viscosity	0		
Oil refractive index	1.426		
Spacer type	Silica		
Ball diameter	0.01905		
Disc track radius	0.04143		
Trigger point	182		
Comments	Idemitsu Kosan FVC32B IG009679 10/7/97		
Temperature=Ambie	45	65°C	Load=20N
M.R.=0.145	Trig. Pt.=182		
Avg. Band Top=234	Bottom=305		
Spacer Layer Film Thickness=478.5			
R.I.25°C=1.4394	45°C=1.4321	65°C=1.4256	
Disc #322			
Number of logged d	130		
Disc Speed (m/s)	Pot Temp (°C)	Lube Temp (°C)	Film (nm)
1.05E-02	24.18706	22.7451	18.96829
1.06E-02	24.22379	22.76033	18.86353
1.36E-02	24.21461	22.74002	23.54374
1.36E-02	24.21461	22.75018	23.47388
1.36E-02	24.19625	22.75018	23.78823
1.96E-02	24.21461	22.75018	29.06175
1.96E-02	24.20543	22.72479	29.02683
0.0196736	24.19165	22.75526	28.7125
0.0271796	24.21002	22.74002	36.04601
2.72E-02	24.21461	22.70448	35.97613
3.94E-02	24.20084	22.72479	45.75288
3.94E-02	24.21461	22.70956	46.10204
5.46E-02	24.21002	22.6994	59.40303
5.46E-02	24.20084	22.72479	59.64736
7.73E-02	24.22379	22.68925	75.0048
7.74E-02	24.20543	22.68925	74.9001
0.1077277	24.20084	22.61816	94.7899
0.1078495	24.21002	22.68417	94.47589
0.1504235	24.2192	22.71464	117.7402
0.1504698	24.2192	22.75018	117.2519
0.21086	24.2192	22.80095	159.7159
0.2110891	24.2192	22.81619	157.605
0.2111258	24.2192	22.78064	157.7961
0.2111364	24.2192	22.78572	159.7159
0.2949194	24.2192	22.78572	198.1319
0.2949701	24.20543	22.78064	198.2752
0.4134723	24.20084	22.78572	245.5975
0.4137894	24.20084	22.7908	245.884
0.5777373	24.20543	22.84665	303.9629
0.5783642	24.19625	22.8365	304.2492
0.8094944	24.1687	22.86696	375.9434
0.8095793	24.20543	22.84157	375.9434
1.133486	24.21002	22.92789	470.2174

EHD Data for Idemitsu Kosan FVC32B - 1st run
(Ambient Temperature = 22.8 ± 0.2°C)

1.133728	24.22379	22.91266	470.5807
1.586663	24.2192	23.03452	573.0204
1.587012	24.23298	23.04975	572.1731
slope=0.687			
1.06E-02	43.23291	44.91355	7.582901
1.06E-02	43.24209	44.94401	8.004152
0.0105874	43.24668	44.9237	8.530701
1.35E-02	43.36147	45.05064	9.478489
1.36E-02	43.31556	45.01002	9.267869
1.96E-02	43.96756	45.72087	12.00588
1.96E-02	43.94001	45.70564	12.2165
2.72E-02	44.00888	45.50254	14.81401
0.0271796	44.01807	45.54824	14.95437
2.72E-02	44.01807	45.54316	14.67359
3.93E-02	43.86195	45.05572	20.00873
0.0393555	43.90787	45.1268	19.51734
5.45E-02	43.74257	44.97956	25.62417
5.46E-02	43.72879	45.0151	25.06263
7.73E-02	43.65074	45.00494	32.85344
0.0773255	43.65533	45.0151	32.01124
0.1077402	43.57727	45.03541	40.29249
0.1077533	43.56809	45.02018	40.43283
0.1077619	43.60023	45.09126	40.78374
0.1504235	43.42575	45.1725	49.9059
0.150457	43.4533	45.25882	50.04625
0.2110215	43.49004	45.35529	62.88546
0.2112935	43.48544	45.37053	62.95563
0.2947854	43.48544	45.32483	78.94853
0.2949072	43.50381	45.28928	79.01865
0.4132766	43.56809	45.08111	99.79859
0.4136226	43.58646	45.07603	99.79859
0.5768927	43.86654	45.92397	128.7851
0.5770968	43.80685	45.39591	122.5748
0.5772784	43.85736	45.90874	128.7851
0.5774254	43.82063	45.43653	122.4346
0.5776868	43.82063	45.38068	122.0842
0.8083387	43.84359	45.69549	162.213
0.8088455	43.8344	45.67517	162.0209
0.8088953	43.82981	45.6701	162.5012
1.132206	43.79308	45.88335	200.5281
1.132487	43.80685	45.94429	200.0481
1.134343	43.82522	45.8732	200.6721
1.586321	43.84818	46.08138	245.8342
1.587114	43.7793	46.04583	246.506
1.588655	43.81144	46.06615	246.7459
slope=0.689			

EHD Data for Idemitsu Kosan FVC32B - 1st run
(Ambient Temperature = 22.8 ± 0.2°C)

1.05E-02	60.90587	65.80754	3.87043
1.05E-02	60.90587	65.71614	4.293447
1.05E-02	60.47886	65.13223	3.799901
1.36E-02	60.51559	65.48257	4.716471
1.37E-02	60.62119	65.59936	5.033738
1.95E-02	60.92883	66.0208	6.09136
1.96E-02	61.00229	66.0868	6.831654
1.97E-02	60.8921	65.98525	5.915077
0.0271531	61.19514	66.15789	8.10066
2.72E-02	61.09412	65.94463	7.853942
2.72E-02	61.14922	66.00048	7.795191
0.0393545	60.45131	65.17285	10.49472
3.94E-02	60.31356	65.03068	10.91773
3.94E-02	60.1804	64.31982	10.6388
3.94E-02	60.14367	64.33506	10.53304
0.0546199	60.61201	65.38611	13.10321
5.46E-02	59.96919	64.22843	13.38824
5.47E-02	60.65792	65.42673	13.66718
7.74E-02	60.62579	65.13731	16.77209
7.75E-02	60.63037	65.20839	16.66637
0.1077282	60.49722	65.63998	21.14267
0.1079319	60.54773	65.6806	20.57877
0.1080289	60.52018	65.67552	21.10742
0.1502444	60.58446	65.67045	26.07687
0.1502872	60.30897	65.29471	25.72434
0.1502908	60.58446	65.66029	25.8654
0.2108854	60.24468	65.33025	32.20877
0.2110002	60.10694	65.08653	32.42023
0.2110241	60.10694	65.09669	32.34974
0.2110399	60.21714	65.28963	31.92686
0.2947856	60.03806	64.84281	41.15914
0.2948748	60.04725	64.85297	41.30007
0.4129131	60.00592	64.67525	52.71533
0.4132542	60.01051	64.74126	52.71533
0.4134974	59.99215	64.57878	52.82103
0.5773434	60.49263	65.37087	66.34602
0.5776495	60.12989	64.70064	66.24203
0.5776803	60.46049	65.28455	66.34602
0.5780754	60.11612	64.64986	66.34769
0.8085327	60.82781	65.97002	83.58452
0.8085808	60.7268	65.82785	84.07754
0.808686	60.4008	65.20332	83.77886
0.8087571	60.69925	65.78215	84.2888
1.13256	60.36406	65.23378	105.2909
1.132624	60.37325	65.34041	105.3613
1.133033	60.38702	65.3201	105.4318
1.585262	60.31356	65.02052	134.0457
1.585312	60.32274	65.15762	133.5179
1.586274	60.30897	65.13223	133.7291
1.586303	60.30437	65.10684	134.0105

EHD Data for Idemitsu Kosan FVC32B - 1st run
(Ambient Temperature = $22.8 \pm 0.2^\circ\text{C}$)

1.586786	60.30437	65.15762	133.729
slope=0.694			

EHD Data for Idemitsu Kosan FVC32B - 2nd Run
(Ambient Temperature = 23.4 ± 0.2°C)

Software version	2		
Lubricant name	FVC32B		
Viscosity	0		
Oil refractive index	1.426		
Spacer type	Silica		
Ball diameter	0.01905		
Disc track radius	0.04176		
Trigger point	77		
Comments	Idemitsu Kosan FVC32B IG09679 10/7/97		
Temperature=Ambie	45	65°C	Load=20N
M.R.=0.140 Trig. Pt.=77			
Avg. Band Top=223 Bottom=298			
Spacer Layer Film Thickness=484.6			
R.I.25°C=1.4394 45°C=1.4321 65°C=1.4256			
Disc #322			
Number of logged da	155		
Disc Speed (m/s)	Pot Temp (°C)	Lube Temp (°C)	Film (nm)
1.07E-02	24.36613	23.32394	18.44279
1.07E-02	24.37991	23.33917	18.23326
1.07E-02	24.37072	23.29855	18.09357
1.37E-02	24.37991	23.34933	21.16694
1.37E-02	24.38909	23.33409	21.16694
1.38E-02	24.37072	23.35948	20.95744
0.0197886	24.37072	23.34933	26.8942
0.0197886	24.3845	23.34933	26.8942
1.98E-02	24.3845	23.36964	26.82438
2.75E-02	24.3845	23.37471	33.87799
2.75E-02	24.3845	23.34933	33.63358
2.75E-02	24.39368	23.34425	33.94784
2.76E-02	24.3845	23.3544	33.84308
3.97E-02	24.3845	23.37471	43.79383
3.98E-02	24.37072	23.36964	43.93346
3.98E-02	24.39368	23.3544	43.4447
5.51E-02	24.38909	23.3544	55.36043
5.52E-02	24.37531	23.36456	55.48843
7.65E-02	24.39368	23.36456	70.18234
7.66E-02	24.37531	23.32902	69.86826
7.66E-02	24.42123	23.35948	69.86826
7.66E-02	24.37531	23.31378	69.86826
0.1072288	24.40746	23.34425	85.81516
0.1072294	24.40746	23.33409	84.73354
0.1072847	24.36154	23.32394	84.83823
0.1072951	24.37531	23.31886	85.46625
0.1073294	24.35695	23.29347	85.90759
0.1073501	24.35236	23.26301	85.90759
0.1501069	24.35236	23.27316	109.2805
0.150218	24.36154	23.25793	109.3502
0.2114362	24.34777	23.26301	151.7506
0.2115487	24.35695	23.28332	151.2727
0.211621	24.34317	23.28839	151.1771
0.2956652	24.34317	23.28332	190.1672
0.2957577	24.36154	23.27824	190.3105

EHD Data for Idematsu Kosan FVC32B - 2nd Run
(Ambient Temperature = 23.4 ± 0.2°C)

0.2958737	24.36154	23.26301	190.3105
0.4139095	24.34777	23.29347	237.451
0.4140277	24.35236	23.29347	237.5942
0.5779629	24.37072	23.32394	293.4294
0.5780255	24.37072	23.33409	293.0477
0.8093462	24.37531	23.37471	364.3164
0.8096994	24.36613	23.36964	364.5549
1.1329	24.37531	23.52196	454.5033
1.133412	24.40746	23.52704	454.5033
1.133625	24.3845	23.4458	455.7147
1.586945	24.41205	23.62351	552.8356
1.58739	24.43501	23.6946	551.8268
1.587972	24.43041	23.6489	552.8356
1.589066	24.39368	23.61843	553.3198
slope=0.696			
1.05E-02	43.65992	45.533	8.802845
1.06E-02	43.68747	45.5787	8.383697
1.06E-02	43.58187	45.45684	8.872708
1.37E-02	43.92624	45.84781	10.47946
0.0137413	43.4533	45.29436	10.40962
1.38E-02	43.49922	45.28928	10.47949
1.38E-02	44.05021	45.97475	10.47949
1.97E-02	44.47263	46.56374	12.43543
1.98E-02	44.50937	46.63483	12.36557
1.98E-02	44.50477	46.62975	12.36557
2.74E-02	44.52314	46.34541	15.22965
2.74E-02	44.51855	46.22355	15.92819
2.75E-02	44.51855	46.36572	15.50907
3.97E-02	44.491	46.05599	20.4335
0.0397448	44.50477	46.04583	20.04934
3.98E-02	44.48182	46.09661	20.32872
5.51E-02	44.46804	46.26925	24.30999
5.51E-02	44.47722	46.18293	24.30999
5.51E-02	44.46345	46.18293	24.41475
7.64E-02	43.95378	45.24866	30.13101
7.64E-02	43.77012	45.07095	30.16594
7.65E-02	43.70125	45.04049	30.16594
7.65E-02	43.93082	45.23851	29.32788
7.65E-02	44.50937	46.18293	31.08457
7.65E-02	44.50937	46.17785	30.80519
0.107136	44.50937	46.42665	38.6615
0.1071465	44.49559	46.44696	38.6615
0.1501132	43.40279	45.46192	46.86599
0.1503482	43.40279	45.5127	47.25002
0.2114006	43.37524	45.39083	58.87421
0.2116688	43.36147	45.43145	58.87421
0.2954468	43.43494	45.16235	75.31224
0.2955731	43.38443	45.27405	75.83569
0.295834	43.41198	45.21312	75.55653
0.4135694	43.77471	45.27913	96.02517

EHD Data for Idematsu Kosan FVC32B - 2nd Run
(Ambient Temperature = 23.4 ± 0.2°C)

0.4136955	43.68747	45.2182	96.16473
0.4145013	43.75175	45.27913	96.16473
0.5777028	43.85277	45.30959	120.2317
0.5778409	43.88491	45.34006	120.2317
0.5778409	43.88491	45.34514	120.2317
0.8092903	43.11908	45.05599	158.3454
0.8095562	43.12826	45.03568	158.3454
0.8095562	43.14663	45.07122	158.3454
1.132886	43.17418	45.36064	194.1801
1.132954	43.22009	45.51804	193.6068
1.133028	43.19254	45.47235	194.1801
1.133443	43.18336	45.35049	194.7533
1.586377	43.29815	45.70084	235.6364
1.586654	43.23846	45.65006	236.8779
1.587208	43.24305	45.61959	236.5914
slope=0.667			
1.06E-02	60.17581	64.78696	4.925515
1.06E-02	60.21254	64.80727	4.750871
1.06E-02	60.12071	64.75141	4.925515
1.37E-02	60.11153	64.89867	5.868669
1.37E-02	60.0197	64.72095	5.763896
1.37E-02	60.08398	64.78696	5.659089
1.37E-02	60.01051	64.68541	5.763896
1.38E-02	60.01511	64.75649	5.659059
1.97E-02	60.32274	65.08145	7.335835
1.98E-02	60.23091	64.97482	7.231007
0.019817	60.29978	65.06114	7.335835
2.74E-02	60.60283	65.41657	8.907619
2.74E-02	60.63956	65.44196	9.221994
2.74E-02	60.57528	65.35564	8.593241
0.0396258	60.7819	65.45719	11.1082
3.97E-02	60.71302	65.38103	11.31776
5.50E-02	60.78649	65.45211	14.04211
5.50E-02	60.85995	65.5232	13.41348
0.0550343	60.84159	65.49781	13.41344
7.64E-02	60.79108	65.70599	17.18556
7.64E-02	60.81404	65.72122	17.74434
0.1070509	60.63497	65.89893	22.21463
0.1070817	60.61201	65.87862	22.52892
0.1071177	60.53854	65.41149	21.99428
0.1072862	60.48344	65.34041	22.20572
0.1500328	61.27779	66.30006	26.43458
0.1500687	61.22269	66.23405	26.22312
0.1500953	61.08035	66.10204	26.22312
0.2112083	61.44308	66.75703	32.35458
0.2113235	61.48441	66.7875	32.35458
0.2955022	61.58542	66.69102	40.8813
0.2957054	61.01607	65.60951	40.81082
0.2957054	61.02525	65.61967	40.81082
0.2957637	61.54869	66.79765	40.81082

EHD Data for Idemitsu Kosan FVC32B - 2nd Run
(Ambient Temperature = 23.4 ± 0.2°C)

0.4133534	60.91505	65.49273	51.09788
0.413777	60.90587	65.57397	50.95697
0.5775451	60.837	65.41657	64.69415
0.5776216	60.81404	65.41657	64.69415
0.8084893	60.32274	64.98498	82.86526
0.8091879	60.32274	65.02052	82.79484
0.8092707	60.71762	65.38611	82.68143
0.8093803	60.70384	65.45211	82.78705
0.8094286	60.72221	65.4318	82.68143
1.131221	60.82781	65.98525	101.2029
1.131742	60.83241	65.96494	101.2029
1.132276	60.71302	65.47242	102.7487
1.13308	60.71762	65.48257	102.6784
1.585479	60.76353	65.8177	127.9511
1.586208	60.76812	65.61967	129.1445
1.586839	60.74517	65.61459	129.0741
1.586927	60.75435	65.60951	129.1445
1.587191	60.74057	65.56889	129.2853
1.587281	60.75894	65.60444	129.3557
slope=0.653			

EHD Data for Idemitsu Kosan FVC68B - 1st Run
(Ambient Temperature = 24.3 ± 0.3°C)

Software version	2		
Lubricant name	FVC68B		
Viscosity	0		
Oil refractive index	1.428		
Spacer type	Silica		
Ball diameter	0.01905		
Disc track radius	0.04278		
Trigger point	402		
Comments	Idemitsu Kosan FVC68B IG09680 10/8/97		
Temperature=Ambient	45	65°C	Load=20N
M.R.=0.140 Trig. Pt.=402			
Avg. Band Top=223 Bottom=298			
Spacer Layer Film Thickness=484.6			
R.I.25°C=1.4420 45°C=1.4350 65°C=1.4281			
Disc #322			
Number of logged data	137		
Disc Speed (m/s)	Pot Temp (°C)	Lube Temp (°C)	Film (nm)
0.0093714	25.15129	24.23789	32.00461
9.43E-03	25.18343	24.24297	32.21368
9.45E-03	25.17884	24.23281	31.37737
1.41E-02	25.20639	24.27343	43.03159
1.41E-02	25.22017	24.2582	43.24063
1.42E-02	25.21098	24.27343	42.82255
2.03E-02	25.22476	24.27343	55.78178
0.0203433	25.26149	24.27343	55.78178
2.04E-02	25.22476	24.27343	55.78178
2.81E-02	25.24771	24.27851	69.57442
2.81E-02	25.27526	24.2582	71.455
2.82E-02	25.2569	24.27851	69.71369
2.82E-02	25.27067	24.27343	70.20129
3.92E-02	25.30281	24.25312	88.16913
3.92E-02	25.30281	24.2582	87.75134
3.93E-02	25.30741	24.27851	89.21366
0.0548947	25.33036	24.27343	113.2329
5.49E-02	25.32577	24.27851	110.4484
5.49E-02	25.35332	24.26328	111.4578
5.49E-02	25.34414	24.2582	111.0053
5.50E-02	25.35332	24.24297	110.5876
7.68E-02	25.3625	24.24297	139.749
7.69E-02	25.35332	24.26836	140.2361
0.1067391	25.38546	24.24297	172.0989
0.1067854	25.41301	24.24805	172.0989
0.1506338	25.14211	24.19727	238.0176
0.150746	25.1467	24.20743	238.6846
0.1508341	25.16047	24.20235	238.3987
0.1509588	25.15129	24.17188	239.8283
0.2102654	25.14211	24.18712	300.1318
0.2103714	25.1467	24.20235	300.7032
0.2104276	25.12833	24.18204	299.4651
0.2104573	25.1467	24.20235	300.0365
0.2950269	25.13293	24.17696	378.9145
0.2950795	25.11456	24.18204	378.6725

EHD Data for Idematsu Kosan FVC68B - 1st Run
(Ambient Temperature = 24.3 ± 0.3°C)

0.2951709	25.13293	24.19219	378.9145
0.295273	25.13752	24.21758	379.1161
0.4131349	25.11915	24.20743	467.5546
0.4135766	25.12374	24.21758	467.5546
0.5777226	25.12374	24.25312	581.8951
0.5781991	25.13752	24.26328	582.115
0.8085272	25.12374	24.3039	712.1578
0.809151	25.11456	24.3496	710.6075
0.809151	25.13293	24.32929	710.6075
0.8093071	25.12374	24.31913	711.4688
1.134135	25.13752	24.507	843.2381
1.135243	25.13752	24.53747	842.7992
1.586238	25.16047	24.63394	940.5174
1.586238	25.16507	24.63902	940.5174
1.587854	25.15588	24.62378	941.3776
slope=0.684			
9.32E-03	43.79308	45.71072	13.66094
9.34E-03	43.66451	45.52793	13.5909
9.37E-03	43.73339	45.61932	13.34572
9.38E-03	43.77012	45.69041	13.66094
1.40E-02	43.83899	45.65487	18.07396
1.40E-02	43.94919	45.65487	18.91451
1.41E-02	43.90787	45.69549	17.86383
2.02E-02	43.98592	45.53808	23.95754
0.020254	43.96297	45.6244	23.11703
2.03E-02	43.97674	45.60409	23.95754
2.81E-02	44.00888	45.45177	28.36987
2.81E-02	44.00429	45.45684	28.36987
2.81E-02	44.00429	45.50254	27.73955
3.91E-02	43.97674	45.38068	34.46267
3.91E-02	43.99052	45.41114	35.02288
3.92E-02	43.98133	45.38576	34.98788
5.48E-02	43.89869	45.34006	44.86114
0.0548256	43.93082	45.36037	44.12593
0.0767661	43.85736	45.35529	55.25803
7.68E-02	43.87114	45.36037	55.25801
0.1066107	43.86195	45.40099	69.25808
0.1066833	43.84818	45.38576	68.90809
0.1506693	43.55432	45.50762	86.9883
0.1507151	43.56809	45.50762	86.7434
0.150891	43.5635	45.54316	87.2682
0.2102366	43.52217	45.50254	110.4261
0.2103481	43.54513	45.50254	110.3561
0.2950753	43.54513	45.467	137.9469
0.2952098	43.54972	45.44669	137.6323
0.412998	43.52677	45.41622	184.9587
0.4130174	43.51758	45.38576	185.0067
0.4131743	43.5084	45.41622	184.8629
0.4132221	43.53595	45.43653	185.1504
0.5777128	43.49004	45.49239	231.4193

EHD Data for Idematsu Kosan FVC68B - 1st Run
(Ambient Temperature = 24.3 ± 0.3°C)

0.5780151	43.5084	45.47208	231.4194
0.5780304	43.52677	45.48731	231.132
0.8086836	43.48544	45.59394	287.429
0.8092623	43.48085	45.61932	286.9505
1.133772	43.49004	45.66502	364.3483
1.134829	43.48544	45.62948	364.4698
1.587234	43.49004	45.75642	443.1059
1.587295	43.49922	45.72595	443.2881
1.588063	43.47167	45.70057	443.4703
slope=0.683			
9.29E-03	60.03806	65.10684	6.590288
9.29E-03	59.72124	64.64986	6.484702
9.34E-03	59.90031	64.95959	6.766299
1.40E-02	60.63956	65.85323	9.75821
1.40E-02	60.66252	65.87862	9.75821
0.0140761	59.73043	64.40107	9.300658
1.41E-02	60.58905	65.7923	9.652621
2.02E-02	60.77731	65.73645	11.06053
2.03E-02	60.82322	65.71107	11.13091
2.81E-02	60.80486	65.60951	14.08753
2.81E-02	60.81404	65.60951	14.36908
2.82E-02	60.82781	65.56382	14.29869
3.91E-02	60.77272	65.35564	18.73328
3.91E-02	60.78649	65.35564	18.24056
3.92E-02	60.76812	65.35564	17.99419
5.33E-02	60.73139	65.36579	22.32299
5.48E-02	60.74057	65.40134	22.00625
5.49E-02	60.73139	65.46227	21.68951
7.68E-02	60.71302	65.58413	28.09425
7.68E-02	60.72221	65.55874	27.60161
0.1065382	60.68547	65.82277	34.35768
0.1066315	60.69466	65.77708	34.35768
0.1504769	60.62579	66.10204	44.13874
0.1506251	60.6166	66.07157	44.06836
0.2101404	60.07939	65.25916	56.38071
0.2102468	60.02429	65.23885	56.31039
0.2951016	60.35947	65.55874	72.55923
0.2951912	60.39621	65.59936	72.41857
0.412721	60.6166	65.39626	88.69885
0.4127537	60.5615	65.3201	88.59338
0.5770942	60.80486	65.70599	114.0083
0.5776021	60.84618	65.73138	114.0083
0.8085433	61.30534	65.47269	138.0289
0.8085669	61.34207	65.55393	137.3965
1.133329	61.7645	65.737	176.2258
1.133386	61.54869	65.20893	169.5733
1.133578	61.72776	65.75223	176.3221
1.133636	61.8196	65.80808	175.8085
1.134017	61.56706	65.29018	169.2221
1.134906	61.51655	65.16324	169.4328

EHD Data for Idematsu Kosan FVC68B - 1st Run
(Ambient Temperature = $24.3 \pm 0.3^{\circ}\text{C}$)

1.585408	62.02621	65.14828	214.5927
1.586196	61.90683	65.06196	215.6034
1.586347	62.0354	65.12289	214.5927
1.586752	61.91143	65.07719	215.5072
slope=0.673			

EHD Data for Idemitsu Kosan FVC68B - 2nd Run
(Ambient Temperature = 22.2 ± 0.5°C)

Software version	2		
Lubricant name	FVC68B		
Viscosity	0		
Oil refractive index	1.428		
Spacer type	Silica		
Ball diameter	0.01905		
Disc track radius	0.04197		
Trigger point	187		
Comments	Idemitsu Kosan FVC68B IG09680 10/9/97		
Temperature=Ambie	45	65°C	
M.R.=0.141 Trig. Pt.=187			
Avg. Band Top=220 Bottom=298			
Spacer Layer Film Thickness=478.9			
R.I.25°C=1.4420 45°C=1.4350 65°C=1.4281			
Disc #322			
Number of logged da	123		
Disc Speed (m/s)	Pot Temp (°C)	Lube Temp (°C)	Film (nm)
1.07E-02	23.15396	21.91747	40.44463
1.07E-02	23.15855	21.90731	40.51433
0.0107254	23.10804	21.88192	41.00214
1.38E-02	23.09427	21.85653	49.57322
1.38E-02	23.12182	21.89716	49.08545
1.38E-02	23.10804	21.887	49.9913
1.99E-02	23.06672	21.86669	63.01996
1.99E-02	23.08968	21.86161	63.08962
0.0199106	23.07131	21.85146	63.15936
2.76E-02	23.03917	21.82607	80.71264
2.76E-02	23.04835	21.8413	80.08579
2.76E-02	23.05294	21.83115	79.56343
3.84E-02	23.00703	21.83115	103.441
3.84E-02	23.02539	21.83623	101.7699
0.0553963	23.00244	21.7956	131.9116
5.54E-02	23.00244	21.78545	133.2339
5.54E-02	23.02539	21.80068	132.6771
7.69E-02	22.99325	21.80576	166.5628
7.69E-02	22.98407	21.7956	166.2845
0.1078088	22.98407	21.7956	202.2419
0.1078311	22.97948	21.78037	202.381
0.1509386	23.15855	21.90731	269.7928
0.1509623	23.15396	21.89208	268.586
0.211001	23.17691	21.92254	336.7025
0.2111753	23.18151	21.9327	336.8453
0.2956728	23.19528	21.96824	429.9539
0.2957924	23.19987	21.96824	430.3167
0.4126076	23.18151	21.98855	527.1393
0.4129725	23.19528	21.97332	526.7768
0.5777869	23.20906	22.06979	655.9951
0.5780725	23.21824	22.05456	656.1416
0.8085917	23.22283	22.22212	792.504
0.8093826	23.2412	22.20688	793.2358
1.133114	23.23201	22.26781	951.9468
1.134311	23.23201	22.22719	951.9468
1.134743	23.23201	22.23227	953.3232

EHD Data for Idemitsu Kosan FVC68B - 2nd Run
(Ambient Temperature = 22.2 ± 0.5°C)

1.586105	23.32844	22.74002	1006.161
1.586394	23.30548	22.71971	1008.913
1.586691	23.30089	22.60801	1009.085
slope=0.666			
1.06E-02	44.80782	45.74653	14.22769
1.06E-02	45.13841	45.24921	14.22769
1.06E-02	44.67925	45.57898	13.66996
1.37E-02	44.88128	45.57898	17.22538
1.38E-02	44.42672	45.80719	17.78309
1.38E-02	44.69303	45.31495	17.05109
1.99E-02	43.92164	45.19789	22.31417
1.99E-02	43.49463	44.76122	22.17476
0.0199106	43.69206	45.0151	21.8611
2.76E-02	43.04465	45.39056	27.68138
2.76E-02	42.87476	45.28394	28.02987
2.76E-02	43.00333	45.3144	27.40257
3.83E-02	42.66814	45.30932	34.58146
3.84E-02	42.60386	45.34487	34.72086
0.0553019	42.06591	45.77192	45.5923
0.0553019	42.46152	44.81707	45.80135
0.0553413	42.08427	45.80239	45.80135
7.68E-02	42.81337	45.22863	58.34314
7.69E-02	42.74909	46.18293	58.1341
0.1076742	42.27519	46.18293	69.22893
0.1076874	42.46249	45.49746	69.12238
0.1077797	44.2706	46.21847	69.01993
0.1077883	43.48544	45.50254	69.36738
0.1507933	44.19714	45.19816	86.5718
0.1510207	44.19714	45.20324	86.57179
0.2108141	43.98133	45.0306	107.461
0.2109147	43.96756	45.01029	107.3914
0.2954114	44.03643	45.14738	134.8166
0.2956463	44.04562	45.12708	134.8862
0.4124628	43.87114	45.97475	169.8263
0.4128748	43.85277	45.55952	170.2437
0.5775537	43.7793	45.54936	227.5617
0.5775713	43.78849	45.53413	227.5141
0.5775846	43.77471	45.54429	227.5617
0.5778515	43.79308	45.52905	227.4187
0.8075291	43.77471	45.58491	281.5899
0.8084469	43.77012	45.57983	281.5423
0.8089883	43.75175	45.57983	281.2883
1.133661	43.68747	45.46812	348.4182
1.133778	43.64156	45.37828	348.7038
1.134339	43.6737	45.35289	348.561
1.13467	43.66911	45.35289	348.561
1.585402	43.57268	45.36304	434.515
1.585436	43.57727	45.31382	435.3615
1.585779	43.5635	45.33921	435.4824
1.585864	43.57727	45.32397	435.2406

EHD Data for Idemitsu Kosan FVC68B - 2nd Run
(Ambient Temperature = 22.2 ± 0.5°C)

slope=0.683			
1.06E-02	60.19418	65.18808	6.687344
1.07E-02	60.18959	65.18808	6.687342
1.38E-02	60.16204	65.16777	7.84902
1.38E-02	60.13449	65.05099	8.165852
1.38E-02	59.94623	64.87328	8.165852
1.38E-02	60.10694	65.12207	7.74341
1.38E-02	61.43849	66.82304	7.743378
1.98E-02	60.62579	65.57905	10.70033
0.0198437	61.53951	65.88905	10.41871
2.75E-02	60.24928	64.42645	13.72755
0.0276139	59.90491	64.91362	14.07955
3.84E-02	59.65237	65.13196	18.30331
0.0552888	60.48804	65.34013	23.23074
0.0553019	60.26764	65.2132	23.79385
0.0767988	59.93246	65.05579	29.42473
7.69E-02	59.87277	65.04057	29.49513
0.1076307	59.64319	65.14719	36.25156
0.1076498	59.6891	65.17766	36.25157
0.1508375	60.05184	65.00529	44.06289
0.1509841	59.98756	64.99513	44.55548
0.2108818	59.95541	65.20332	56.51701
0.2110256	59.94623	65.18808	56.44664
0.2955005	59.88654	65.05099	71.77769
0.295558	59.87277	65.0256	71.6722
0.412587	59.89113	64.78188	90.45046
0.412914	59.89573	64.79711	90.55592
0.5773375	59.94623	64.6651	113.6526
0.577856	59.93246	64.72095	113.7229
0.8089481	60.02888	64.94944	144.0852
0.8093109	60.0197	64.84789	144.4365
1.133564	60.38243	65.8177	191.0338
1.133804	60.31356	65.71614	191.6115
1.134253	60.29519	65.66537	191.9004
1.134467	60.35947	65.81261	190.9375
1.58539	60.43753	66.25944	232.3328
1.586292	60.48344	66.32037	232.1403
1.586493	60.47426	66.35083	232.3328
1.58657	60.46967	66.38638	231.9157
slope=0.708			

EHD Data for Suniso 3GS Under R-22 Pressure (~10 wt%)
(T=23.3 ± 0.5°C, P=4.19 bars; T=45°C, P=5.70 bars; T=65°C, P=7.29 bars)

Software version	2		
Lubricant name	Suniso 3GS		
Viscosity	0		
Oil refractive index	1.481		
Spacer type	Silica		
Ball diameter	0.01905		
Disc track radius	0.04265		
Trigger point	397		
Comments	Suniso 3GS under R-22 pressure 2/12/98		
Temperature=Ambi	45	65°C	Load=20N
M.R.=0.140 Trig. Pt.=55			
Avg. Band Top=223 Bottom=298			
Spacer Layer Film Thickness=459.5			
R.I.25°C=1.4954 45°C=1.4887 65°C=1.4814			
Disc #333			
Number of logged d	145		
Disc Speed (m/s)	Pot Temp (°C)	Lube Temp (°C)	Film (nm)
1.06E-02	24.45337	23.34425	6.516931
1.07E-02	24.47633	23.32394	6.079525
1.38E-02	24.45796	23.30871	8.098242
1.38E-02	24.44419	23.30871	8.434689
0.0200046	24.46255	23.41533	10.52063
2.01E-02	24.44878	23.42549	10.55426
2.78E-02	24.45796	23.46611	12.67381
3.88E-02	24.44419	23.47626	17.11456
3.89E-02	24.44878	23.47626	17.11456
5.45E-02	24.43501	23.48642	21.48772
0.0545209	24.43501	23.50673	21.15134
5.45E-02	24.41205	23.50165	21.35316
7.63E-02	24.43501	23.51688	27.60973
7.64E-02	24.42123	23.52704	27.60977
0.1076439	24.43041	23.56258	35.88382
0.1076444	24.44878	23.54227	36.01834
0.1497865	24.45337	23.58797	46.37622
0.1498531	24.43501	23.57781	46.57795
0.2108784	24.44419	23.60828	58.88423
0.2109161	24.43041	23.60828	58.95147
0.2950241	24.43041	23.63367	75.22186
0.2950606	24.44419	23.61336	75.86044
0.2950771	24.43501	23.63367	75.69238
0.4125705	24.17329	22.8365	99.4941
0.4133082	24.19165	22.81111	99.49409
0.5785088	24.17329	22.84157	125.193
0.5788339	24.19625	22.87204	124.79
0.8087451	24.20084	22.86696	157.429
0.8089177	24.19625	22.87204	157.4961
1.133048	24.22379	22.96851	209.9262
1.133083	24.25134	22.98882	209.4662
1.587454	24.22839	23.05991	259.5917
1.588144	24.23757	23.04975	259.3159
2.221569	24.32481	23.38487	343.9605
2.222386	24.32481	23.43564	343.8227

EHD Data for Suniso 3GS Under R-22 Pressure (~10 wt%)
(T=23.3 ± 0.5°C, P=4.19 bars; T=45°C, P=5.70 bars; T=65°C, P=7.29 bars)

3.110378	24.39827	23.7403	427.7677
3.110494	24.37991	23.71998	428.1178
3.111052	24.39827	23.69967	427.9428
slope=0.740			
0.0106529	44.89965	45.69603	3.344567
1.07E-02	44.89046	45.77219	3.040513
1.38E-02	43.98133	46.17277	4.054002
1.38E-02	44.08235	46.42665	3.78374
1.38E-02	43.72879	45.74626	4.054002
1.38E-02	44.08694	46.42157	3.78374
2.00E-02	42.34673	44.3601	5.067475
2.00E-02	42.71865	44.54797	4.72963
2.00E-02	42.48448	44.42103	4.763415
2.78E-02	42.08042	44.43626	6.688954
2.78E-02	42.08501	44.45657	6.688955
2.79E-02	42.07583	44.41087	6.688954
3.88E-02	42.59468	45.15727	7.803693
3.88E-02	42.59468	45.1268	7.567235
3.88E-02	42.61763	45.18266	8.10773
3.88E-02	42.09879	44.49719	8.513144
3.89E-02	42.12175	44.50227	8.44558
5.45E-02	42.68192	45.21312	9.796726
5.45E-02	42.66355	45.26897	9.931853
7.63E-02	42.7462	45.30959	12.7693
7.63E-02	42.75538	45.28421	12.97197
0.1075649	42.8564	45.40607	16.31597
0.1076064	42.79671	45.36545	16.8226
0.107631	42.84721	45.39083	16.68751
0.1076901	42.8564	45.41622	16.41729
0.1497581	42.94823	45.40099	21.68628
0.1498675	42.92068	45.41114	21.68628
0.2106883	42.98496	45.44161	27.96809
0.2107858	42.98496	45.47208	27.76548
0.2951253	43.06302	45.533	36.68055
0.2951562	43.03088	45.54824	36.7481
0.4128923	42.94823	45.47208	48.99393
0.4131971	42.96659	45.47715	48.9939
0.579123	42.91609	45.467	62.56451
0.5791274	42.92986	45.53808	62.362
0.8092251	42.94364	45.57363	79.97946
0.8092533	42.92068	45.5127	79.97943
0.8096204	42.99414	45.60409	79.70766
0.8096423	42.96659	45.54824	79.5052
1.133665	42.98955	45.55839	99.74944
1.134001	42.99874	45.533	99.74943
1.58939	43.0171	45.60917	125.3159
1.590837	43.03088	45.56347	125.6531
2.221525	43.21454	45.65994	168.9204
2.222424	43.2375	45.63456	168.9204
3.11094	43.15944	45.55331	208.6767

EHD Data for Suniso 3GS Under R-22 Pressure (~10 wt%)
(T=23.3 ± 0.5°C, P=4.19 bars; T=45°C, P=5.70 bars; T=65°C, P=7.29 bars)

3.113106	43.21454	45.52285	208.5844
slope=0.743			
0.0106529	59.60646	65.28455	2.040489
1.07E-02	59.39065	64.99513	1.938549
1.07E-02	59.56054	65.17285	1.734778
1.38E-02	59.20699	64.79711	2.346144
1.39E-02	59.24372	64.80727	2.346163
1.39E-02	59.23913	64.81235	2.346144
2.00E-02	59.24372	64.75649	3.025457
0.0200455	59.3126	64.82758	3.025457
2.01E-02	59.18403	64.64986	3.229256
2.79E-02	59.49626	65.21854	4.112316
2.80E-02	59.59727	65.35564	3.976454
3.88E-02	59.75798	65.65521	4.893495
3.89E-02	59.80389	65.68568	4.995396
3.89E-02	59.73961	65.62982	5.063334
5.45E-02	59.85899	65.6806	6.761513
5.46E-02	59.88195	65.7466	6.727562
0.0545653	59.89573	65.75169	6.421912
0.0764275	59.94623	65.79739	8.731397
7.65E-02	60.06561	65.85323	8.255908
0.1077115	60.22632	65.60951	11.31249
0.1077995	60.18499	65.78723	11.53891
0.1079314	60.19418	65.56382	11.72005
0.149806	60.10234	65.5232	14.23315
0.1499125	60.11612	65.42673	13.90175
0.1499261	60.13449	65.33533	13.79987
0.21074	60.12989	65.45719	18.18065
0.2108619	60.12989	65.45211	18.11272
0.2955756	59.28505	65.29951	24.1464
0.2956313	59.23913	65.27921	24.04455
0.2956318	59.51463	65.53308	23.70499
0.2956387	59.30341	65.29951	24.04453
0.2957668	59.29882	64.33506	23.8408
0.4137385	58.83507	64.85777	30.08843
0.4137443	58.83966	64.94917	29.95262
0.5795552	58.96363	64.79176	39.11936
0.5800433	58.94068	64.89331	39.05146
0.8096929	59.06924	65.00502	49.16742
0.8102888	60.23091	65.73138	45.02618
0.8104526	59.05088	64.93393	49.09953
1.132696	60.53395	65.45211	55.95395
1.133855	60.49722	65.46227	55.95395
1.134306	60.50181	65.4318	55.95395
1.13483	60.42376	65.98017	60.09637
1.135177	60.4559	66.08173	60.09637
1.588402	60.46967	65.48766	75.5685
1.589326	60.51099	65.42165	76.31499
1.590247	60.55691	66.25436	78.21685
1.590489	60.55691	66.26452	78.08112

EHD Data for Suniso 3GS Under R-22 Pressure (~10 wt%)
 (T=23.3 ± 0.5°C, P=4.19 bars; T=45°C, P=5.70 bars; T=65°C, P=7.29 bars)

1.590576	60.49263	65.50288	76.00961
1.592276	59.59727	64.70064	76.99539
1.592702	59.67533	64.81742	76.89359
2.225286	59.95082	64.9799	96.53583
2.225862	59.98296	65.01037	95.9931
2.22808	60.5615	65.90401	94.39889
2.228358	60.52936	65.94463	94.29714
3.11301	60.24009	65.14746	116.1366
3.11496	60.17122	65.2287	115.594
3.115081	60.60742	65.4775	116.713
3.118026	60.57528	65.45719	116.713
3.119729	60.54773	65.60444	116.8147
slope=0.727			

EHD Data for Suniso 3GS Under R-22 Pressure (~20 wt%)
(T=23 ± 0.5°C, P=6.81 bars; T=45°C, P=10.12 bars; T=65°C, P=13.43 bars)

Software version	2		
Lubricant name	Suniso 3GS		
Viscosity	0		
Oil refractive index	1.495		
Spacer type	Silica		
Ball diameter	0.01905		
Disc track radius	0.04464		
Trigger point	140		
Comments	Suniso 3GS under R-22 pressure 2/13/98		
Temperature=Ambi	45 65°C Load=20N		
M.R.=0.138 Trig. Pt.=140			
Avg. Band Top=220 Bottom=287			
Spacer Layer Film Thickness=452.4			
R.I.25°C=1.4984 45°C=1.4887 65°C=1.4814			
Disc #333			
Number of logged d	144		
Disc Speed (m/s)	Pot Temp (°C)	Lube Temp (°C)	Film (nm)
9.40E-03	24.32022	23.05483	2.826619
9.47E-03	24.31562	23.05991	2.826597
9.48E-03	24.35695	23.05483	3.028516
0.0143121	24.31103	23.0396	3.634175
0.0143345	24.33858	23.07514	3.701486
1.43E-02	24.3294	23.07006	3.634175
0.0206819	24.30644	23.07006	4.576353
2.08E-02	24.32481	23.04975	4.845551
2.08E-02	24.34777	23.05991	4.744595
2.71E-02	24.33399	23.08529	5.451229
2.72E-02	24.34317	23.08529	5.451229
2.72E-02	24.34777	23.08529	5.653132
0.0272279	24.33399	23.08529	5.653123
4.01E-02	24.32022	23.08022	7.470152
4.01E-02	24.33399	23.08022	7.873942
4.01E-02	24.33399	23.09545	7.672038
5.46E-02	24.33399	23.10053	9.287109
5.46E-02	24.32481	23.09545	9.488993
0.0546539	24.34317	23.1056	9.488993
7.71E-02	24.3294	23.12084	11.70966
7.72E-02	24.34317	23.12592	11.91155
7.72E-02	24.3294	23.1056	11.50778
0.1077647	24.33858	23.08529	15.34335
0.1077928	24.33399	23.15638	15.14148
0.1078422	24.34777	23.1513	14.60319
0.1496363	24.33858	23.16146	19.38064
0.1496637	24.32481	23.15638	19.48157
0.2107635	24.30644	23.18177	25.43612
0.2108283	24.34777	23.18177	25.43612
0.2109028	24.32481	23.18177	25.5034
0.2942423	24.30644	23.23762	31.59205
0.2947752	24.31562	23.22239	31.76028
0.4139585	24.2192	22.79588	41.58172
0.414172	24.20084	22.79588	41.58171
0.5785637	24.21461	22.86188	52.81413

EHD Data for Suniso 3GS Under R-22 Pressure (~20 wt%)
(T=23 ± 0.5°C, P=6.81 bars; T=45°C, P=10.12 bars; T=65°C, P=13.43 bars)

0.5790144	24.20084	22.85173	52.88137
0.8087602	24.20084	22.86696	66.19644
0.8089421	24.19165	22.86188	66.09557
1.132581	24.21002	22.89235	83.94555
1.132949	24.22839	22.88219	83.7439
1.585715	24.17788	22.90758	105.9237
1.586162	24.2192	22.94312	105.6213
1.587076	24.25134	23.06499	104.4304
2.220629	24.25593	23.11576	130.7011
2.221236	24.23757	23.12592	130.2309
3.106027	24.27889	23.23254	164.1463
3.10754	24.29267	23.2427	163.8777
3.10754	24.29726	23.26301	163.8777
slope=0.712			
9.45E-03	42.6911	44.62413	1.570947
9.47E-03	42.93904	44.83739	1.470021
9.48E-03	43.24668	45.14711	1.301775
1.43E-02	42.49366	44.40072	1.974747
1.43E-02	42.43397	44.34995	1.772844
2.07E-02	42.28704	44.36518	2.378553
2.07E-02	42.24113	44.32964	2.378553
2.08E-02	42.27327	44.34995	2.378553
2.72E-02	42.39724	44.54797	3.186179
2.72E-02	42.34673	44.37533	2.984259
2.72E-02	42.37428	44.46673	2.984259
4.01E-02	42.41561	44.64952	3.791835
4.01E-02	42.39265	44.62413	3.791835
5.45E-02	42.48448	44.64444	4.599373
5.46E-02	42.45234	44.65459	4.666677
5.47E-02	42.47989	44.64952	4.700329
7.71E-02	42.41561	44.65459	6.416423
7.72E-02	42.49366	44.6089	6.416423
0.1076588	42.31918	44.61398	7.627779
0.1078144	42.54876	44.6089	7.538067
0.1078354	42.53958	44.59367	7.425897
0.1078555	42.53499	44.58859	7.560485
0.149641	42.84721	44.9694	10.19309
0.149641	42.56713	44.64952	10.05043
0.149641	42.57631	44.63428	10.15135
0.149704	42.53958	44.64444	10.20744
0.1497129	42.58549	44.64444	10.11771
0.2105172	42.87017	45.03033	14.43249
0.210808	42.94823	45.04049	14.2979
0.210858	42.91609	45.05572	14.43249
0.2108976	42.43856	44.75107	13.88606
0.2944398	42.64059	44.82723	18.32707
0.2944872	43.10434	45.31975	18.26795
0.294528	43.11812	45.29436	18.46983
0.2945773	42.62682	44.86277	18.32707
0.2946166	43.04924	45.31975	18.20066

EHD Data for Suniso 3GS Under R-22 Pressure (~20 wt%)
(T=23 ± 0.5°C, P=6.81 bars; T=45°C, P=10.12 bars; T=65°C, P=13.43 bars)

0.4141266	43.34769	45.4213	24.35967
0.4141716	43.1824	45.37053	24.33724
0.4145312	43.32933	45.43653	24.42696
0.5788208	43.26505	45.32483	31.49112
0.5791331	43.22831	45.3756	31.28932
0.8097762	43.24209	45.30959	40.37092
0.8101642	43.23291	45.29944	40.37092
1.134913	43.26964	45.28421	52.27611
1.135417	43.26505	45.24866	52.17522
1.590283	43.28341	45.21312	65.79294
1.590489	43.26505	45.19789	65.79294
2.225571	43.24209	45.17758	83.32573
2.225955	43.26964	45.1725	84.04642
2.226364	43.27882	45.15727	84.14729
2.227222	43.22372	45.25882	83.32573
3.114329	43.27882	45.16742	104.6992
3.115247	43.29259	45.13188	104.6992
3.115646	43.30178	45.18266	104.6992
slope=0.759			
2.07E-02	58.7111	64.74126	1.467553
2.07E-02	58.89017	64.83266	1.669447
2.72E-02	60.00133	66.32545	1.893781
2.72E-02	60.06102	66.34576	1.904999
2.73E-02	60.04266	66.35083	1.904999
4.01E-02	59.40902	65.26933	2.611653
4.01E-02	59.39524	65.19823	2.880835
4.02E-02	59.29423	65.11192	2.67894
5.46E-02	58.50448	64.31475	3.587489
5.47E-02	58.57335	64.40107	3.284653
5.48E-02	58.55039	64.45184	3.58749
0.0771783	58.74324	64.54832	4.159503
7.72E-02	58.51366	64.44169	4.159499
7.73E-02	58.50907	64.4163	4.294086
0.1078492	58.91313	64.92405	5.20263
0.1079154	58.94986	65.01545	5.20263
0.1079436	58.5458	64.44676	5.505462
0.1498099	58.99578	65.02052	7.255159
0.149839	59.0371	64.9799	7.322448
0.149959	59.01873	64.96467	7.322448
0.211183	58.67896	64.89867	10.55258
0.2950225	59.26668	64.96467	14.38827
0.2951038	59.23913	64.96975	14.18639
0.4147385	59.10597	65.117	18.93272
0.4147946	59.00955	65.09669	18.9327
0.4149487	59.12893	65.0256	19.13459
0.5796385	59.13352	65.2287	24.88733
0.5796402	59.12434	65.35056	24.98824
0.8105537	59.18403	65.41657	32.25425
0.8110934	59.19781	65.4775	32.18697
1.135124	59.24831	65.48766	41.33572

EHD Data for Suniso 3GS Under R-22 Pressure (~20 wt%)
(T=23 ± 0.5°C, P=6.81 bars; T=45°C, P=10.12 bars; T=65°C, P=13.43 bars)

1.136106	59.27127	65.3201	41.33572
1.591355	59.34015	65.45211	53.2407
1.591523	59.34473	65.37087	53.2407
2.229051	59.46871	65.1627	67.56422
2.229109	59.46412	65.19316	67.63148
2.230228	59.47789	65.20839	67.66511
3.117352	59.39983	64.80727	86.20561
3.117764	59.43657	64.77173	86.23922
3.119553	59.37688	64.9342	86.30641
slope=0.810			

EHD Data for Suniso 3GS Under R-22 Pressure (~40 wt%)
(T=22.7 ± 0.4°C, P=9.29 bars; T=45°C, P=14.32 bars; T=65°C, P=19.50 bars)

Software version	2		
Lubricant name	Suniso 3GS		
Viscosity	0		
Oil refractive index	1.481		
Spacer type	Silica		
Ball diameter	0.01905		
Disc track radius	0.04194		
Trigger point	67		
Comments	Suniso 3GS under R-22 pressure 11/24/98		
Temperature=Amb	45 65°C Load=20N		
M.R.=0.140 Trig. Pt.=63			
Avg. Band Top=237 Bottom=287			
Spacer Layer Film Thickness=477.3			
R.I.25°C=1.4954 45°C=1.4887 65°C=1.4814			
Disc #424			
Number of logged c	105		
Disc Speed (m/s)	Pot Temp (°C)	Lube Temp (°C)	Film (nm)
1.96E-02	23.98962	22.66894	1.41413
1.97E-02	23.97126	22.63847	1.616172
1.97E-02	23.94371	22.6334	1.41413
1.97E-02	23.97585	22.6334	1.616172
2.89E-02	23.94371	22.66894	1.919203
2.89E-02	23.97585	22.6334	2.020207
2.90E-02	23.95748	22.64863	1.919203
3.97E-02	23.95748	22.68417	2.491566
3.97E-02	23.95748	22.66894	2.491599
3.97E-02	23.96667	22.70448	2.42422
5.52E-02	23.92534	22.72987	3.434307
0.0552636	23.98962	22.75018	3.23229
7.67E-02	23.95289	22.76541	4.040407
7.68E-02	23.88861	22.78572	4.242354
0.1074575	23.97126	22.82634	5.656444
0.1074883	23.94371	22.83142	5.353412
0.1075832	23.96207	22.8365	5.454422
0.1076022	23.95289	22.84157	5.656444
0.1505775	23.93452	22.87712	7.272468
0.150699	23.9483	22.89743	7.070449
0.1507899	23.93912	22.87204	6.935811
0.2104221	23.97585	22.88219	8.787521
0.2107109	23.93452	22.85173	8.787521
0.2108831	23.94371	22.86188	8.68651
0.2951692	23.85188	23.00406	11.58178
0.2952574	23.90697	23.01421	11.71645
0.4140375	23.64066	22.37952	15.82349
0.414308	23.63148	22.3389	15.8908
0.5787499	23.65444	22.34398	20.30054
0.5790299	23.65903	22.37444	20.30054
0.8100209	23.64985	22.3846	25.85439
0.8102746	23.66362	22.42014	25.92172
1.135415	23.68658	22.45568	32.31646

EHD Data for Suniso 3GS Under R-22 Pressure (~40 wt%)
(T=22.7 ± 0.4°C, P=9.29 bars; T=45°C, P=14.32 bars; T=65°C, P=19.50 bars)

1.135553	23.66821	22.42522	32.31646
1.587687	23.70954	22.4963	41.09987
1.588713	23.69117	22.48615	40.99889
2.224511	23.72331	22.59278	51.63165
2.224535	23.7279	22.61816	51.39614
3.109596	23.83351	22.82634	65.22289
3.110191	23.80596	22.76033	65.22289
slope=0.755			
5.52E-02	42.70028	45.48223	2.231169
5.53E-02	42.70028	45.50254	2.095954
7.69E-02	42.49366	45.22836	2.636847
7.69E-02	42.55795	45.17758	2.636847
7.69E-02	42.59008	45.18773	2.83968
0.1076765	42.33296	45.30452	3.448138
0.107792	42.20898	45.36037	3.549554
0.1507258	42.636	45.21312	4.867956
0.1507525	42.52121	45.26897	4.867938
0.150757	42.53499	45.45177	4.462254
0.210831	42.55795	44.93386	6.287732
0.2110291	42.57631	45.0151	6.084877
0.2954412	42.65437	45.37053	8.011653
0.2955056	42.61304	45.18266	8.045457
0.2959972	42.70488	45.34514	8.113065
0.4143573	42.57172	44.9694	10.47923
0.4146092	42.45693	44.79676	10.27638
0.5799239	42.53958	44.94909	13.92688
0.5800161	42.59468	44.88816	13.79168
0.8104479	42.41101	44.62921	18.7263
0.8106036	42.29623	44.49719	18.72628
0.8106644	42.37428	44.52766	18.79389
1.136882	42.5809	44.99479	24.13367
1.136991	42.47989	44.89324	24.33647
1.589201	42.2044	44.94882	31.43295
1.58947	42.30082	45.0656	31.23024
1.590031	42.10797	44.95898	31.43295
2.226527	42.49825	45.19762	39.06935
2.227959	42.39724	45.18238	39.54232
3.109966	42.59008	45.14684	49.475
3.110542	42.5809	45.14684	49.57634
3.111637	42.56713	45.11638	49.67767
slope=0.794			
5.51E-02	59.67533	65.2442	1.563451
5.51E-02	59.54218	65.2442	1.733393
5.52E-02	59.70288	65.30006	1.733393
7.65E-02	60.73598	65.4473	2.243222
7.66E-02	60.89669	65.50824	2.141248
0.1071218	59.37228	65.34013	2.719062

EHD Data for Suniso 3GS Under R-22 Pressure (~40 wt%)
(T=22.7 ± 0.4°C, P=9.29 bars; T=45°C, P=14.32 bars; T=65°C, P=19.50 bars)

0.1073035	59.3126	65.38075	2.719062
0.1074536	60.63497	65.91924	2.651088
0.1510779	57.60912	65.22843	3.26288
0.151092	58.18307	65.74607	3.568752
0.1511888	57.38873	65.52266	3.466764
0.2109537	58.8167	65.51305	4.486358
0.2111191	58.74783	65.49781	4.282447
0.2113118	58.78456	65.35056	4.486358
0.2949758	61.163	65.34576	6.321697
0.295244	61.02984	65.53362	6.593559
0.2957378	59.08302	65.25916	5.709915
0.2957571	59.0371	65.57397	5.811877
0.4136058	58.09124	64.65467	8.020959
0.4137203	58.0545	64.88824	7.952971
0.5784569	59.11057	64.44676	10.90961
0.5786915	59.1473	64.46707	10.94359
0.8097538	59.44575	64.75649	15.08952
0.809948	59.56513	64.86312	15.29342
1.135186	59.7442	64.72603	20.0507
1.135532	59.87736	64.8225	20.28859
1.586588	60.02429	64.7311	25.28335
1.588201	60.11612	64.64479	25.48722
1.589077	60.07939	64.66002	25.4872
2.225389	60.27682	64.61432	31.8066
2.225997	60.22632	64.64479	31.8066
3.109955	60.46049	64.80219	40.36739
3.11244	60.44212	64.76157	40.36739
slope=0.815			

EHD Data for Suniso 3GS Under R-22 Pressure (~60 wt%)
(T=22.8 ± 0.2°C, P=9.63 bars; T=45°C, P=16.53 bars)

Software version	2		
Lubricant name	Suniso 3GS		
Viscosity	0		
Oil refractive index	1.489		
Spacer type	Silica		
Ball diameter	0.01905		
Disc track radius	0.04226		
Trigger point	82		
Comments	Suniso 3GS under R-22 pressure 2/18/98		
Temperature=Ambi	45°C Load=20N		
M.R.=0.140 Trig P.t=82			
Avg. Band Top=234 Bottom=298			
Spacer Layer Film Thickness=491.5			
R.I.25°C=1.4954 45°C=1.4887			
Disc #368			
Number of logged c	68		
Disc Speed (m/s)	Pot Temp (°C)	Lube Temp (°C)	Film (nm)
5.41E-02	24.30185	22.9025	1.31171
5.41E-02	24.29726	22.89235	1.31171
5.41E-02	24.29726	22.9025	1.278067
7.73E-02	24.30644	22.91774	1.614401
7.73E-02	24.30644	22.90758	1.614378
7.74E-02	24.30644	22.9025	1.950736
7.74E-02	24.26512	22.9025	1.917128
7.74E-02	24.3294	22.91774	1.614401
7.74E-02	24.32481	22.89743	1.614401
7.74E-02	24.30644	22.89743	1.816176
0.1068519	24.29267	22.91774	2.421637
0.1068551	24.30185	22.9025	2.354324
0.1069916	24.31562	22.9025	2.320667
0.1501967	24.29267	22.88727	3.2288
0.1502148	24.24675	22.91774	3.2288
0.1502245	24.28348	22.91774	3.027004
0.2106072	24.30185	22.93805	3.834123
0.2106443	24.29267	22.92789	3.834123
0.2106492	24.29726	22.91774	3.766914
0.2106894	24.31562	22.92789	4.035971
0.2939743	24.27889	22.92281	5.246746
0.2943996	24.27889	22.92789	5.179475
0.2944311	24.27889	22.90758	5.65034
0.41182	24.08146	22.70448	6.65922
0.4120284	24.13196	22.6994	6.65922
0.4121248	24.14115	22.6994	6.65922
0.5778826	24.15033	22.71464	8.139024
0.5782571	24.15951	22.6994	8.273536
0.8090358	24.12737	22.71971	10.08953
0.8092109	24.15492	22.73495	10.08953
1.132864	24.17329	22.74002	12.71256
1.132995	24.15492	22.76541	12.77983
1.586051	24.19165	22.87712	15.80632
1.586238	24.1687	22.82126	15.80632

EHD Data for Suniso 3GS Under R-22 Pressure (~60 wt%)
(T=22.8 ± 0.2°C, P=9.63 bars; T=45°C, P=16.53 bars)

1.586748	24.15951	22.85173	15.80632
2.219917	24.19625	22.91774	18.46276
2.219917	24.19165	22.94312	18.46276
2.220817	24.15492	22.9025	18.56362
slope=0.724			
0.1072533	43.38902	45.81227	1.479891
0.1072533	43.37524	45.83258	1.479891
0.1072856	43.66911	45.75134	1.681677
0.1508364	43.40739	45.29436	2.320667
0.1509167	42.98955	44.98971	2.219812
0.2115558	42.636	44.48704	2.690643
0.2115606	42.34214	45.13669	2.444057
0.2115646	42.33755	45.11638	2.556158
0.2954709	41.78656	44.43091	3.363341
0.2955012	42.07124	44.66956	3.834123
0.2955537	41.8738	44.51215	3.733291
0.2955591	42.12175	44.74572	3.430592
0.4140054	42.1998	44.68987	4.338637
0.4140054	42.18143	44.80157	4.338637
0.4141462	41.99777	44.68479	4.439549
0.5799604	42.93904	44.47688	5.65034
0.5804043	42.87017	44.38549	5.583076
0.5812665	42.9115	44.34487	5.65034
0.8126666	43.1273	44.59367	7.466397
0.8127577	43.1824	44.63936	7.264617
0.8129354	43.08598	44.61398	7.466397
1.139134	42.87936	44.69521	9.181547
1.139474	42.83344	44.70537	9.28245
1.139515	42.85181	44.64444	9.181547
1.594909	42.86099	44.68506	10.96389
1.595887	42.90231	44.65967	11.30013
1.597878	42.90231	44.62413	11.0984
2.232527	42.77834	44.70029	13.58692
2.232838	42.93904	44.72568	13.72143
2.233016	42.92068	44.71553	13.72143
slope=0.714			

EHD Data for Suniso 4GS Under R-22 Pressure (~10 wt%)
(T=23.2 ± 0.5°C, P=4.32 bars; T=45°C, P=6.05 bars; T=65°C, P=7.77 bars)

Software version	2		
Lubricant name	Suniso 4GS		
Viscosity	0		
Oil refractive index	1.484		
Spacer type	Silica		
Ball diameter	0.01905		
Disc track radius	0.04275		
Trigger point	454		
Comments	Suniso 4GS under R-22 pressure 12/2/98		
Temperature=Ambi	45	65°C	Load=20N
M.R.=0.145	Trig. Pt.=454		
Avg. Band Top=237	Bottom=287		
Spacer Layer Film Thickness=483.4			
R.I.25°C=1.4980	45°C=1.4910	65°C=1.4839	
Disc #424			
Number of logged c	131		
Disc Speed (m/s)	Pot Temp (°C)	Lube Temp (°C)	Film (nm)
1.07E-02	24.26512	23.14622	9.877877
1.07E-02	24.25593	23.14622	9.7771
1.37E-02	24.25134	23.20716	11.79281
1.37E-02	24.25593	23.21223	11.8936
1.38E-02	24.27889	23.20208	11.69206
2.00E-02	24.25134	23.28839	15.43891
2.00E-02	24.2743	23.27824	15.74123
2.79E-02	24.2743	23.32394	20.47761
2.79E-02	24.26512	23.32394	20.67916
0.0388822	24.2743	23.35948	25.98627
3.89E-02	24.2743	23.38487	26.12063
3.89E-02	24.25593	23.42041	26.52368
5.47E-02	24.25134	23.44072	34.78564
5.47E-02	24.23757	23.42041	34.28194
5.47E-02	24.23757	23.43564	34.04687
7.66E-02	24.25593	23.46103	42.91236
7.67E-02	24.25593	23.45088	43.04668
0.108031	24.25134	23.45088	53.72396
0.1080366	24.25134	23.47119	53.9254
0.1503164	24.23298	23.54735	70.10584
0.1505428	24.24216	23.56766	70.6429
0.2114751	24.23757	23.58797	88.56409
0.211642	24.22379	23.58289	88.76543
0.294365	24.21461	23.66413	110.439
0.2945516	24.24216	23.6489	112.3175
0.2946128	24.2192	23.64382	111.5124
0.2946464	24.2192	23.62859	112.3175
0.4123897	24.22839	23.53212	144.4455
0.4125259	23.8932	22.65371	156.6063
0.4125712	23.86565	22.64355	156.7595
0.4126522	24.24216	23.53212	144.3114
0.579075	23.91157	22.66386	195.8648
0.579171	23.90697	22.66894	195.2676
0.8096113	23.92993	22.76033	243.9327

EHD Data for Suniso 4GS Under R-22 Pressure (~10 wt%)
(T=23.2 ± 0.5°C, P=4.32 bars; T=45°C, P=6.05 bars; T=65°C, P=7.77 bars)

0.8100645	23.95748	22.75018	243.2899
1.134833	23.98044	22.88727	309.5062
1.134904	23.95748	22.88219	309.6228
1.587421	23.98503	22.95328	381.4571
1.588194	23.97585	22.9482	381.3405
2.224229	24.06768	23.28839	472.9303
2.224772	24.0585	23.27316	473.213
3.107651	24.17788	23.67937	567.8104
3.108573	24.15951	23.72506	567.3865
slope=0.727			
1.06E-02	43.54054	44.75615	4.539382
1.07E-02	43.72879	44.98518	4.741892
0.0106925	43.88491	45.02525	4.539382
1.38E-02	42.962	44.84995	5.552055
1.38E-02	42.84625	44.93824	5.552055
2.00E-02	44.66088	45.48731	7.172259
2.00E-02	44.91342	45.78688	6.969739
2.01E-02	42.1493	45.06052	7.172259
2.78E-02	44.22009	45.10649	8.995029
2.79E-02	42.22276	45.16715	8.7925
0.0388786	42.19062	44.93626	11.6953
3.89E-02	42.36969	44.89056	11.6953
3.90E-02	42.53499	44.97025	11.83031
5.46E-02	42.11715	44.76122	15.47548
5.46E-02	42.15848	44.85262	15.27296
0.0765423	42.25949	45.0151	19.72795
7.66E-02	42.27327	44.99987	19.72793
0.1079042	42.5258	45.22836	25.70122
0.1080168	42.53958	45.21312	25.59998
0.1080627	42.47989	45.16742	25.66747
0.1504216	42.89313	45.54316	32.7537
0.1505428	42.93445	45.51777	32.88867
0.211532	43.41198	45.6701	41.50355
0.2115894	43.38902	45.50762	41.99841
0.2116316	43.34311	45.65487	41.72845
0.2116709	43.37984	45.56855	41.52605
0.2946689	43.24209	45.29436	53.83916
0.2947125	43.30178	45.36037	53.94034
0.294778	43.34769	45.41622	53.83916
0.4126549	42.38806	44.6749	73.9062
0.4127214	42.31	44.61905	73.90623
0.57886	42.4707	44.65967	91.16913
0.5790872	42.5809	44.75107	91.20493
0.5793064	42.4707	44.61398	90.96684
0.8095925	42.91609	45.39591	114.7004
0.8096905	42.94364	45.37053	114.4982
1.134685	42.7462	45.08111	148.2838
1.13524	42.71406	45.04556	148.6543
1.588164	42.31	44.6749	190.4632
1.588395	42.31918	44.70029	190.6017

EHD Data for Suniso 4GS Under R-22 Pressure (~10 wt%)
(T=23.2 ± 0.5°C, P=4.32 bars; T=45°C, P=6.05 bars; T=65°C, P=7.77 bars)

2.224238	42.28245	44.5632	236.8441
2.224985	42.33296	44.57843	236.8441
3.109079	42.49366	44.56828	294.0372
3.10917	42.50285	44.57843	294.2678
3.110578	42.44775	44.57843	294.4061
slope=0.744			
1.06E-02	59.17751	64.95932	2.932801
1.06E-02	59.28771	64.97963	2.932801
1.38E-02	60.55691	65.26452	3.546812
1.39E-02	60.42376	65.28483	3.546812
2.01E-02	60.97934	65.42192	4.560794
2.01E-02	61.09412	65.45238	4.560794
0.0279157	60.95734	65.35831	5.578218
2.80E-02	59.36769	64.64959	5.578244
3.89E-02	58.86625	65.21292	8.02007
3.89E-02	58.88462	65.08599	7.71483
0.0546717	58.15552	64.60416	10.05484
5.47E-02	61.25024	65.65549	9.851359
7.66E-02	58.04991	64.8132	12.90343
7.68E-02	58.31163	64.73083	12.49651
0.1080168	59.84063	65.30246	16.26059
0.1080383	58.34837	64.82645	16.7014
0.150264	60.36406	65.36184	20.63478
0.1504255	60.35488	65.38568	20.7704
0.2116341	60.20336	65.34816	25.5173
0.2117192	60.19418	65.36339	25.5173
0.2945679	60.62579	65.38878	33.24722
0.2948079	60.57528	65.34153	33.45064
0.4122791	59.69829	65.25916	43.21335
0.4127943	59.62941	64.96975	43.21335
0.5788583	59.29423	64.95692	55.00815
0.5791556	59.45953	64.9163	54.73701
0.5794734	59.54314	65.07103	54.80481
0.8092874	59.80848	64.94944	70.25688
0.8104445	59.84522	65.00021	70.05356
1.135635	60.19877	65.36184	87.09629
1.136241	60.20795	65.3466	87.16405
1.136424	60.07117	65.39118	88.1442
1.587595	59.66155	64.7768	109.72
1.587858	59.60646	64.71079	109.9232
1.58856	59.96919	65.34548	108.7719
1.588774	60.01051	65.40134	108.7042
1.589042	59.7993	65.11192	109.5846
2.223868	59.48248	64.85692	139.9866
2.224952	59.46412	64.87568	140.2574
3.108655	59.69829	64.29444	182.9884
3.109607	59.73043	64.80967	183.1276
3.110215	59.77634	64.82998	183.0812
slope=0.724			

EHD Data for Suniso 4GS Under R-22 Pressure (~15 wt%)
(T=23.2 ± 0.3°C, P=5.63 bars; T=45°C, P=8.12 bars; T=65°C, P=10.32 bars)

Software version	2			
Lubricant name	Suniso 4GS			
Viscosity	0			
Oil refractive index	1.484			
Spacer type	Silica			
Ball diameter	0.01905			
Disc track radius	0.04331			
Trigger point	493			
Comments	Suniso 4GS under R-22 pressure 1/30/98			
Temperature=Ambi	45	65°C	Load=20N	
M.R.=0.139	Trig. Pt.=449			
Avg. Band Top=229	Bottom=298			
Spacer Layer Film Thickness=473.3				
R.I.25°C=1.4980	45°C=1.4910 65°C=1.4839			
Disc #334				
Number of logged d	142			
Disc Speed (m/s)	Pot Temp (°C)	Lube Temp (°C)	Film (nm)	
1.09E-02	24.4396	23.16146	5.622409	
1.09E-02	24.42582	23.16653	5.689554	
1.09E-02	24.43501	23.16146	5.488119	
1.41E-02	24.43041	23.197	6.898188	
1.41E-02	24.43501	23.19192	7.099596	
2.04E-02	24.42582	23.22746	10.12104	
2.04E-02	24.41664	23.19192	9.919606	
2.04E-02	24.4396	23.20208	10.02033	
2.83E-02	24.4396	23.21731	12.40379	
2.84E-02	24.43041	23.21223	12.1352	
0.0394423	24.43501	23.23762	15.55926	
3.95E-02	24.3845	23.22746	15.49213	
3.95E-02	24.44419	23.24778	15.55926	
5.54E-02	24.43041	23.25793	21.13134	
5.54E-02	24.43501	23.27824	21.19846	
7.60E-02	24.38909	23.2427	27.50849	
7.60E-02	24.43041	23.25793	27.9448	
0.107733	24.3294	23.27824	34.75751	
0.1078051	24.41205	23.27824	34.28767	
0.1078101	24.42582	23.29855	34.28767	
0.1078764	24.41205	23.30363	34.28767	
0.1505079	24.41205	23.33409	44.75718	
0.1505692	24.3845	23.32902	45.02565	
0.1506504	24.43041	23.31378	44.85789	
0.1507117	24.41664	23.31378	45.02565	
0.210758	24.42123	23.41533	59.04948	
0.2107586	24.39827	23.38995	59.25076	
0.2109284	24.3845	23.35948	59.04949	
0.2932446	24.38909	23.42549	74.74725	
0.2933108	24.36613	23.43564	74.546	
0.2934806	24.40286	23.42549	74.74725	
0.4127079	24.23757	22.85681	98.67425	
0.4127157	24.25593	22.87204	98.57368	
0.413099	24.24216	22.85681	98.47308	
0.5762591	24.24675	22.86696	126.7633	

EHD Data for Suniso 4GS Under R-22 Pressure (~15 wt%)
(T=23.2 ± 0.3°C, P=5.63 bars; T=45°C, P=8.12 bars; T=65°C, P=10.32 bars)

0.5764377	24.25593	22.91774	126.6515
0.5773369	24.26053	22.91266	126.7633
0.8079154	24.23757	22.91774	163.7328
0.8085854	24.23298	22.87204	155.4161
0.8086357	24.25593	22.86696	155.3156
0.8088886	24.26971	22.95328	163.8246
1.13245	24.2743	23.01421	202.5292
1.132705	24.26971	23.0396	202.2997
1.583949	24.29267	23.07006	249.2014
1.584224	24.30185	23.1056	247.6415
1.585289	24.31103	23.11068	247.825
1.585907	24.26512	23.06499	249.2014
2.216758	24.33399	23.30363	310.3556
2.216825	24.31103	23.25793	310.7052
2.217539	24.3294	23.30363	310.3556
3.105727	24.37991	23.52196	379.5686
3.106669	24.35236	23.46611	379.5686
slope=0.751			
0.0108768	43.84818	45.51804	2.666799
0.0108781	43.17781	45.14204	2.273256
1.09E-02	43.84359	45.53328	2.610566
1.09E-02	43.82522	45.33018	2.846729
1.09E-02	42.92068	44.83231	2.273256
1.09E-02	43.48085	45.6244	2.779264
1.40E-02	42.23194	44.41087	2.981659
1.41E-02	42.0896	44.26363	3.183975
1.41E-02	42.12634	44.22808	3.183975
2.04E-02	42.39724	44.62921	4.713519
2.04E-02	42.45693	44.73076	4.579195
2.04E-02	42.41101	44.64444	4.881378
2.83E-02	42.53958	44.82215	6.794957
0.028331	42.52121	44.81707	6.492836
2.84E-02	42.48448	44.74091	6.257835
3.95E-02	42.65896	44.95925	8.003612
3.95E-02	42.61763	44.93386	8.137901
3.95E-02	42.59008	44.90339	8.137901
5.54E-02	42.636	44.94909	10.62211
5.54E-02	42.72324	45.0151	10.62211
7.59E-02	42.77375	45.02525	13.24054
7.60E-02	42.75538	45.04049	13.64339
0.1077136	42.81048	45.00494	18.27582
0.1077567	42.85181	45.1268	18.27582
0.1506581	42.87476	45.09634	22.90783
0.1507221	42.84262	45.08619	23.37772
0.2109363	42.94823	45.18266	31.06352
0.2109425	42.94823	45.18773	31.09709
0.2109695	42.97119	45.15727	31.16422
0.2934335	43.01251	45.2182	38.21147
0.2935548	43.02629	45.20805	38.21147
0.4127304	43.18699	45.34514	47.97826

EHD Data for Suniso 4GS Under R-22 Pressure (~15 wt%)
(T=23.2 ± 0.3°C, P=5.63 bars; T=45°C, P=8.12 bars; T=65°C, P=10.32 bars)

0.4127329	43.15944	45.34006	47.84406
0.5763438	43.17321	45.32483	62.06861
0.5764861	43.09516	45.32483	62.00151
0.8078266	43.20076	45.467	79.76288
0.808275	43.20536	45.54316	81.52157
0.8084162	43.19158	45.46192	81.58863
0.8088574	43.17781	45.46192	79.29337
1.132962	43.18699	45.40607	100.2835
1.133067	43.17321	45.43145	100.4846
1.585705	43.17321	45.467	128.5058
1.587081	43.18699	45.47715	128.6398
2.217678	43.26046	45.45684	157.9899
2.217716	43.22831	45.45684	157.8559
3.103072	43.21913	45.2639	193.7473
3.104227	43.23291	45.24866	193.2786
slope=0.773			
1.40E-02	59.63401	64.55847	1.473072
1.41E-02	59.34015	64.80812	1.473072
0.0141578	59.28505	64.83196	1.676403
2.04E-02	60.12071	64.92913	2.680484
2.04E-02	60.09316	64.89359	2.275715
2.83E-02	61.18137	66.1325	3.085314
2.84E-02	60.2355	64.92405	3.085283
2.84E-02	60.23091	64.96467	3.085283
3.95E-02	60.87832	65.80246	4.501979
3.95E-02	60.60742	65.74153	4.344586
3.95E-02	60.57069	65.73645	4.367059
0.0395594	60.99311	66.01064	4.434534
5.54E-02	60.32274	65.40642	5.783711
5.54E-02	60.31356	65.37087	5.817445
5.55E-02	60.1804	65.28455	5.716243
7.60E-02	59.83144	64.83773	7.672602
7.60E-02	59.99674	65.00529	7.515218
7.61E-02	59.8544	64.86312	7.740051
0.1078252	59.67074	64.83266	11.11293
0.1078931	59.76716	64.63463	11.18039
0.1506234	59.61564	64.62447	14.2833
0.1507557	59.70747	64.72095	14.77793
0.1507929	59.56972	64.52293	14.21587
0.2110244	59.52381	64.45184	19.88161
0.2110835	59.5284	64.47723	19.6793
0.2111524	59.5284	64.46707	19.74672
0.2935366	59.4182	64.3046	25.24347
0.2937912	59.29423	64.29951	25.1423
0.4131123	60.06561	65.35056	32.7941
0.4131866	60.06561	65.41149	32.72669
0.5765592	60.06561	65.36072	41.72855
0.5766772	60.02888	65.39118	41.8297
0.808917	59.99674	65.33025	53.49325
0.808917	60.02888	65.19823	53.49325

EHD Data for Suniso 4GS Under R-22 Pressure (~15 wt%)
 (T=23.2 ± 0.3°C, P=5.63 bars; T=45°C, P=8.12 bars; T=65°C, P=10.32 bars)

1.133647	59.99215	65.30486	68.52473	
1.134065	59.97837	65.23378	68.72691	
1.584388	60.12989	65.06622	86.44834	
1.58604	60.07479	65.30486	86.51752	
1.587117	60.09776	65.30486	86.65228	
2.218376	60.08857	64.94944	108.3432	
2.220078	60.12071	64.91898	108.2758	
3.105753	60.17581	64.59909	136.6949	
3.105973	60.1253	64.63971	136.5603	
slope=0.827				

EHD Data for Suniso 4GS Under R-22 Pressure (~30 wt%)
(T=23.3 ± 0.3°C, P=8.67 bars; T=45°C, P=12.74 bars; T=65°C, P=17.08 bars)

Software version	2		
Lubricant name	Suniso 4GS		
Viscosity	0		
Oil refractive index	1.491		
Spacer type	Silica		
Ball diameter	0.01905		
Disc track radius	0.045		
Trigger point	104		
Comments	Suniso 4GS under R-22 pressure 2/4/98		
Temperature=Ambi	45	65°C	Load=20N
M.R.=0.136 Trig. Pt.=104			
Avg. Band Top=241 Bottom=312			
Spacer Layer Film Thickness=457.6			
R.I.25°C=1.4980 45°C=1.4910 65°C=1.4839			
Disc #334			
Number of logged c	76		
Disc Speed (m/s)	Pot Temp (°C)	Lube Temp (°C)	Film (nm)
9.69E-03	24.65999	23.29855	1.813318
9.72E-03	24.64163	23.34933	1.813318
1.46E-02	24.6554	23.30871	2.149153
0.0146606	24.67377	23.3544	2.149147
1.47E-02	24.64622	23.30363	2.014825
1.95E-02	24.65081	23.33409	3.223733
1.95E-02	24.64622	23.34425	3.022268
1.95E-02	24.64622	23.34933	2.820776
1.96E-02	24.6554	23.34425	3.022268
2.78E-02	24.65081	23.34425	3.895335
2.78E-02	24.65999	23.3544	3.492388
2.79E-02	24.64163	23.34933	3.626698
3.93E-02	24.64622	23.4001	5.037028
3.94E-02	24.68754	23.43057	4.701248
3.94E-02	24.69673	23.41026	4.63412
5.42E-02	24.67377	23.47626	6.044421
5.43E-02	24.67836	23.4458	6.111589
5.43E-02	24.68295	23.4458	5.999649
5.43E-02	24.62785	23.45595	6.2459
0.0543484	24.69673	23.46103	6.044421
7.73E-02	24.67836	23.49657	8.462095
7.74E-02	24.67836	23.50165	8.462095
7.74E-02	24.68295	23.51181	8.260641
0.1069943	24.6554	23.56258	10.54391
0.1070518	24.66459	23.53719	10.52153
0.1498091	24.6554	23.53212	13.16287
0.1499356	24.67836	23.56766	13.49862
0.2107518	24.65081	23.58797	16.9233
0.2108065	24.6554	23.57274	17.12477
0.2108246	24.6554	23.53719	16.82257
0.2930511	24.64163	23.6032	21.75789
0.2932545	24.63244	23.62859	21.69074
0.293284	24.64163	23.61843	21.35499
0.293327	24.6554	23.59305	21.35499
0.4122158	24.58194	23.22746	28.20345

EHD Data for Suniso 4GS Under R-22 Pressure (~30 wt%)
(T=23.3 ± 0.3°C, P=8.67 bars; T=45°C, P=12.74 bars; T=65°C, P=17.08 bars)

0.4122396	24.52684	23.21223	28.40488
0.5772046	24.56357	23.19192	36.46103
0.5772386	24.5498	23.2427	36.7631
0.5773411	24.56816	23.22239	36.39391
0.8086331	24.56816	23.26301	46.83194
0.8090907	24.55898	23.27316	46.86551
1.132608	24.56357	23.29855	58.30854
1.133316	24.58194	23.30363	58.30854
1.582125	24.59571	23.42549	73.30568
1.582828	24.59112	23.42549	73.30568
2.21663	24.62326	23.48134	92.8269
2.216697	24.61867	23.49657	92.8269
3.099695	24.61867	23.58797	114.1529
3.100497	24.61867	23.57781	114.1529
3.100603	24.63244	23.51688	114.1529
slope=0.737			
1.47E-02	41.70391	44.89832	1.821855
0.0147032	41.7085	44.89324	1.518217
1.95E-02	41.80952	45.1725	1.771271
1.95E-02	41.83707	45.1725	1.92309
1.96E-02	41.80033	45.13188	1.788133
2.78E-02	41.80493	45.09126	2.732798
2.79E-02	41.90135	45.32483	2.429167
3.94E-02	41.56617	44.89832	3.44133
3.95E-02	41.69014	44.89324	3.441332
3.95E-02	41.69014	44.88308	3.542548
5.43E-02	41.82329	45.35529	4.858333
7.74E-02	42.36969	45.95444	5.645504
7.74E-02	42.43397	46.02552	6.612624
7.75E-02	42.40642	45.92905	6.612624
0.0774801	42.40642	45.97475	6.612624
0.1071156	42.87936	46.30987	7.894602
0.1072781	42.35132	45.83258	7.422312
0.1072847	42.80589	46.33525	7.557279
0.107459	42.77834	46.2794	7.692214
0.1499131	42.33755	46.18801	10.32362
0.150013	42.43397	44.96432	9.311461
0.1501731	42.12175	45.64471	10.25611
0.2108503	42.16766	46.02552	13.56212
0.2109212	42.24113	46.28955	13.49464
0.2109564	42.42938	45.02525	12.95479
0.2111571	42.40642	44.9694	12.44878
0.2112039	42.36051	45.06587	12.54999
0.2112081	42.41561	44.98463	12.41505
0.2113426	42.22735	46.20832	13.56212
0.2935801	41.67636	45.29944	17.13774
0.2935926	41.59372	45.34006	17.20518
0.293687	42.41561	45.02018	16.39557
0.2937708	42.4202	44.87801	16.1257
0.4123322	41.91053	45.39083	21.8601

EHD Data for Suniso 4GS Under R-22 Pressure (~30 wt%)
(T=23.3 ± 0.3°C, P=8.67 bars; T=45°C, P=12.74 bars; T=65°C, P=17.08 bars)

0.4124295	41.97941	45.36037	21.96129
0.4127066	42.25031	45.48223	21.15165
0.4128977	42.2549	45.56855	21.05047
0.4129349	43.00333	46.44188	21.92756
0.4129812	42.23653	45.52793	21.11792
0.5772979	42.37428	45.85289	29.04426
0.5774098	42.3651	45.85797	29.04425
0.5785372	42.20898	45.49746	27.93116
0.5786614	42.35592	45.82243	28.94307
0.578744	42.37887	45.88843	29.01053
0.5787678	42.16766	45.50762	27.93116
0.5788612	42.35132	45.94429	28.94307
0.809927	42.14011	45.40607	36.22755
0.8100798	42.15848	45.3756	36.29499
1.133846	42.16307	45.41114	46.54603
1.134003	42.21358	45.39083	46.54603
1.134829	42.29163	45.28421	46.54603
1.586884	42.31459	45.27405	58.54856
1.588013	42.31	45.32991	58.48111
2.22126	42.40183	45.06079	75.26762
2.221365	42.36969	45.11665	76.68308
2.221449	42.41101	45.09634	76.07644
2.221957	42.44316	45.04049	75.20022
3.104529	42.49825	44.97956	96.09303
3.104768	42.49825	44.94909	96.09303
3.1051	42.49366	44.93386	95.82346
slope=0.769			
1.47E-02	56.48878	65.15762	1.012144
1.96E-02	57.69177	66.84335	1.417013
1.96E-02	57.71932	66.88905	1.417013
2.80E-02	57.84329	67.24448	2.294222
2.80E-02	58.04532	67.40696	2.02431
3.96E-02	58.32541	67.83347	2.631625
3.97E-02	58.34377	67.87409	2.631625
5.45E-02	58.70651	68.14828	3.441347
5.46E-02	58.67896	68.08227	3.373864
5.46E-02	58.69273	68.12797	3.441347
7.77E-02	58.7662	67.32064	4.251045
7.78E-02	58.66059	67.32571	4.554685
0.1075355	58.61008	66.75196	5.46557
0.1075728	58.62386	66.79765	5.398106
0.1076815	58.68814	67.0363	5.667994
0.150522	58.55039	65.45719	7.489748
0.1507958	58.53203	65.40134	7.489747
0.2117972	58.48611	65.56889	9.98624
0.2118693	58.53662	65.57397	10.32362
0.2946001	58.47693	65.29979	12.95488
0.2946219	58.4907	65.2287	13.02234
0.4140255	56.40613	64.46707	16.59805
0.4141092	56.39235	64.45692	16.69926

EHD Data for Suniso 4GS Under R-22 Pressure (~30 wt%)
 (T=23.3 ± 0.3°C, P=8.67 bars; T=45°C, P=12.74 bars; T=65°C, P=17.08 bars)

0.4144104	56.4796	64.5737	16.53058
0.5798047	56.43827	64.58894	21.25294
0.5799957	56.57143	64.70572	21.3204
0.81273	56.72295	64.81742	27.66142
0.8128836	56.69999	64.84281	27.72887
1.137861	57.01222	64.96467	35.75554
1.138052	56.94793	64.91389	35.82299
1.594202	57.27853	65.09669	45.93927
1.595004	57.09946	65.01037	45.93927
2.228051	57.90757	65.04591	57.46997
2.229101	57.62749	65.00529	57.16658
3.113084	58.21521	64.90882	71.96484
3.113502	58.23357	64.85804	71.93112
3.115726	57.92135	64.89867	72.03225
slope=0.775			

EHD Data for Suniso 4GS Under R-22 Pressure (~50 wt%)
(T=23 ± 0.5°C, P=9.70 bars; T=45°C, P=16.32 bars)

Software version	2		
Lubricant name	Suniso 4GS		
Viscosity	0		
Oil refractive index	1.498		
Spacer type	Silica		
Ball diameter	0.01905		
Disc track radius	0.04315		
Trigger point	65		
Comments	Suniso 4GS under R-22 pressure 1/26/98		
Temperature=Amb	45°C Load=20N		
M.R.=0.139 Trig. Pt.=65			
Avg. Band Top=223 Bottom=305			
Spacer Layer Film Thickness=472.3			
R.I.25°C=1.4980 45°C=1.4910 65°C=1.4839			
Disc #334			
Number of logged	84		
Disc Speed (m/s)	Pot Temp (°C)	Lube Temp (°C)	Film (nm)
2.83E-02	24.47174	23.11068	1.913767
2.83E-02	24.47633	23.13099	2.215934
3.94E-02	24.47174	23.16653	2.518072
3.94E-02	24.49929	23.16146	2.618789
3.94E-02	24.48551	23.16146	2.820249
0.0549993	24.37072	23.00913	3.155982
5.51E-02	24.40286	23.01929	3.122396
5.53E-02	24.48551	23.14115	3.223154
7.71E-02	24.37531	23.03452	3.827496
0.0770549	24.39368	23.03452	3.424603
7.71E-02	24.37991	23.04467	3.827427
0.1070055	24.39827	23.04975	4.700409
0.1070461	24.39827	23.07514	4.431813
0.1075297	24.46255	23.10053	4.700384
0.1502358	24.42123	23.11068	5.237626
0.1502642	24.47174	23.13099	5.539752
0.150298	24.46255	23.12592	5.506176
0.1511577	24.38909	23.07006	5.237626
0.1511784	24.3845	23.04975	5.103308
0.2109638	24.36613	23.07514	6.446201
0.2110353	24.37531	23.05991	6.345471
0.2110444	24.35236	23.06499	6.4462
0.292917	24.37991	23.01929	8.057655
0.2930131	24.37531	23.06499	7.990564
0.2947538	24.36613	23.05991	8.124847
0.2949281	24.36154	23.05991	8.460593
0.4115453	24.0034	22.55723	11.28054
0.411764	24.36154	23.06499	10.13913
0.4119135	23.98044	22.55723	11.2134
0.4120546	24.36613	23.03452	10.54197
0.4122056	24.34777	23.01929	10.47482
0.4131621	24.47174	23.12084	9.669118
0.5765366	24.03095	22.56231	13.83187
0.5767159	24.48092	23.22239	12.79119
0.5770452	24.01258	22.50646	13.7983
0.8082223	23.99422	22.59785	16.51735

EHD Data for Suniso 4GS Under R-22 Pressure (~50 wt%)
(T=23 ± 0.5°C, P=9.70 bars; T=45°C, P=16.32 bars)

0.8084309	24.0034	22.60293	16.58449
1.131696	24.01717	22.59278	20.74677
1.131855	24.01717	22.60293	20.74677
1.583543	24.02636	22.7908	24.77458
1.583588	24.03095	22.78572	24.77458
2.217263	24.1641	23.00406	29.13779
2.217985	24.06768	22.82126	29.4063
2.218271	24.13655	22.99898	29.20494
2.218703	24.04013	22.86696	29.47342
3.102411	24.19165	23.03452	33.83628
3.103038	24.20084	23.07006	33.16508
Slope=0.610			
3.96E-02	45.47359	45.76149	1.410151
3.96E-02	45.00525	45.10142	1.61157
3.96E-02	45.00066	45.10142	1.913753
3.96E-02	45.00525	44.95925	1.410151
5.55E-02	45.34503	45.86304	1.913763
5.55E-02	45.47818	45.83258	2.350227
5.55E-02	45.70776	46.12708	1.813071
5.55E-02	45.56543	46.0763	2.014455
5.56E-02	45.50114	45.84274	2.014455
7.77E-02	45.73531	46.13215	2.618789
7.78E-02	45.81337	46.36572	2.82027
0.1079527	45.87765	46.32002	3.626054
0.107999	45.82255	46.19816	3.827427
0.1080113	45.91438	46.14738	3.558879
0.1508998	45.01903	45.47208	5.237539
0.15097	45.02362	45.45684	4.230389
0.1510452	45.00066	45.47208	5.036106
0.2112673	45.0374	45.44669	6.04337
0.2114249	45.05576	45.05572	5.439012
0.2116913	45.11545	45.13696	5.136833
0.295487	44.95015	45.65994	6.647661
0.2955075	44.93638	45.57363	6.849085
0.4147505	44.68843	45.6244	8.661964
0.4148223	44.88128	45.68025	9.064835
0.4148931	44.91342	45.7158	9.400562
0.5800441	44.88128	45.76657	11.41484
0.5800897	44.84914	45.80719	11.48196
0.8129291	44.65629	45.30959	14.43607
0.8130125	44.68384	45.28421	14.77184
1.137567	44.62415	45.34514	17.92718
1.137886	44.61956	45.39083	18.02787
1.592352	44.63334	45.35022	22.35796
1.592628	44.62875	45.53808	22.2237
2.227713	44.63793	45.73103	25.68081
2.229387	44.50477	45.72595	25.68081
3.118474	44.71598	46.07122	30.41314
3.118833	44.69762	45.93921	30.01043
slope=0.693			

EHD Data for ICI Emkarate RL32H Under R-134a Pressure (~10 wt%)
(T=23 ± 0.5°C, P=2.12 bars; T=45°C, P=3.57 bars; T=65°C, P=4.94 bars)

Software version	2		
Lubricant name	ICI Emkarate RL32H		
Viscosity	0		
Oil refractive index	1.437		
Spacer type	Silica		
Ball diameter	0.01905		
Disc track radius	0.04365		
Trigger point	339		
Comments	ICI RL32H under R-134a pressure 4/21/98		
Temperature=Ambi	45	65°C	Load=20N
M.R.=0.141 Trig. Pt.=148			
Avg. Band Top=234 Bottom=283			
Spacer Layer Film Thickness=467.9			
R.I.25°C=1.4510 45°C=1.4440 65°C=1.4370			
Disc #370			
Number of logged d	149		
Disc Speed (m/s)	Pot Temp (°C)	Lube Temp (°C)	Film (nm)
1.09E-02	23.77382	22.51154	7.380802
1.09E-02	23.74627	22.51661	7.519454
1.10E-02	23.74627	22.52169	8.004727
1.41E-02	23.77382	22.47599	9.460417
1.42E-02	23.78759	22.542	9.529731
1.42E-02	23.75545	22.53185	9.460417
1.94E-02	24.01717	22.86696	12.346303
1.94E-02	24.02636	22.87204	12.318917
2.85E-02	23.80596	22.62832	14.86736
0.0285496	23.82892	22.61816	15.07531
0.0285651	23.80137	22.62832	14.86737
3.98E-02	23.84269	22.70956	19.99666
3.98E-02	23.84728	22.70956	19.75408
5.42E-02	23.86565	22.76033	24.84832
5.42E-02	23.82892	22.79588	25.05625
7.66E-02	23.86106	22.81619	31.91742
7.66E-02	23.87024	22.81619	31.77881
7.67E-02	23.88402	22.82126	31.91742
0.1070333	23.87483	22.87712	39.8865
0.1070919	23.88861	22.85173	40.23294
0.1071015	23.88402	22.87204	39.95579
0.1503006	23.87024	22.97359	50.21032
0.1503692	23.85647	22.90758	49.65606
0.1504163	23.87024	22.97867	49.93319
0.2109467	23.8932	23.04467	64.96586
0.2111054	23.87483	23.04467	64.75806
0.2942587	23.82892	23.06499	83.38837
0.2942792	23.87483	23.11576	82.83442
0.2942874	23.82892	23.05483	83.04214
0.4131762	23.6774	22.46076	104.4744
0.4131771	23.6774	22.42522	104.4398
0.5780653	23.69576	22.43029	133.9242
0.5780795	23.68658	22.45061	133.6013
0.8083138	23.69117	22.46584	166.111

EHD Data for ICI Emkarate RL32H Under R-134a Pressure (~10 wt%)
(T=23 ± 0.5°C, P=2.12 bars; T=45°C, P=3.57 bars; T=65°C, P=4.94 bars)

0.8087258	23.69117	22.46584	166.3876
0.8088573	23.70495	22.51154	174.1153
0.8089437	23.72331	22.51154	174.305
1.130957	23.72331	22.4963	214.7846
1.130984	23.72331	22.51154	215.1638
1.58452	23.71872	22.74002	265.4788
1.584561	23.7325	22.63847	266.5682
2.221494	23.81055	23.14115	314.3152
2.22349	23.77382	23.02436	316.3608
3.108686	23.85647	23.21731	372.6656
3.111066	23.83351	23.16146	372.9664
slope=0.703			
0.0104177	42.3651	44.89832	3.343354
1.50E-02	42.69569	44.99987	4.806022
1.51E-02	42.69569	45.06079	4.806022
1.96E-02	44.06857	44.25347	5.43285
2.87E-02	42.67273	45.26336	7.940169
2.87E-02	40.6754	45.21766	8.358094
2.88E-02	42.43397	45.21766	7.940169
0.039379	46.05213	45.58886	10.02954
3.95E-02	46.41487	46.2337	9.611667
5.47E-02	43.24209	45.13669	11.86224
5.49E-02	43.30178	45.13669	11.86224
7.75E-02	42.08042	45.09099	15.20507
7.75E-02	42.21817	44.93359	14.71759
7.76E-02	42.23194	44.9082	15.76216
0.1082041	42.44316	45.28901	19.66184
0.1082562	42.48448	45.30424	18.89588
0.1508626	43.23291	44.87293	24.6754
0.150912	43.36606	44.75615	25.44135
0.2102133	42.94823	44.63936	30.03677
0.21023	42.98955	44.6089	30.59374
0.2104613	42.95741	44.66475	30.28045
0.2943699	42.78753	44.32455	39.01783
0.2945702	42.71406	44.23316	39.22667
0.4134015	44.24305	45.9189	49.38975
0.4135	44.04562	45.84274	49.38975
0.5775928	43.48085	45.5127	62.96143
0.5781936	43.45789	45.46192	62.96141
0.8092389	42.87936	45.03541	78.51328
0.8095012	43.07679	45.25374	78.51328
1.130685	43.10893	45.0656	99.74465
1.131062	42.90231	44.86758	99.88376
1.583002	42.54417	44.358832	129.1599
1.583858	42.1998	44.52231	128.4646
1.58438	42.21358	44.52231	128.5342
2.223034	43.00333	44.84754	168.4194
2.223778	43.28801	45.11157	168.0859
3.103489	43.63237	45.39083	202.1878
3.108992	43.64156	45.48731	202.045

EHD Data for ICI Emkarate RL32H Under R-134a Pressure (~10 wt%)
(T=23 ± 0.5°C, P=2.12 bars; T=45°C, P=3.57 bars; T=65°C, P=4.94 bars)

slope=0.705			
1.05E-02	59.45953	65.14239	2.099817
1.05E-02	59.97837	65.51812	1.889801
1.05E-02	59.42279	65.24901	2.099817
1.51E-02	59.9646	65.35056	2.729688
1.51E-02	59.98756	65.36579	2.729688
1.96E-02	60.02888	65.42165	3.149695
1.97E-02	60.01511	65.30994	3.149695
2.87E-02	60.22632	65.78215	4.409457
2.88E-02	60.34111	65.80246	4.409457
3.94E-02	60.39621	65.88371	5.31933
3.94E-02	60.43753	65.90401	5.249337
5.47E-02	60.41916	66.12234	6.299177
5.48E-02	60.49722	66.23913	6.299177
7.77E-02	60.96097	66.52855	8.398796
7.77E-02	60.98393	66.56409	8.608752
0.1081678	60.96097	66.0868	11.26813
0.1081998	60.9426	66.11726	11.26814
0.108235	60.95638	66.0868	11.33813
0.1509847	60.93801	65.72122	14.97713
0.1509863	60.85077	65.70091	15.11708
0.21045	60.94719	65.69583	19.10577
0.210451	60.90587	65.63998	19.17576
0.2945224	60.91046	65.73645	24.77354
0.2946873	60.97015	65.83292	24.91348
0.4138515	60.80027	65.82785	31.4903
0.5791962	60.21254	64.85297	40.61986
0.5796397	60.17122	64.95959	40.61986
0.5797167	60.11153	64.73618	40.51492
0.8103628	60.42835	65.21347	52.89557
0.8105605	60.52477	65.30994	52.79069
1.133504	61.2686	66.31529	66.87524
1.133524	60.77731	65.67045	66.74252
1.585803	61.33289	66.39146	81.97772
1.586329	61.27779	66.39653	82.11752
2.219936	61.13086	66.1325	113.14
2.221481	61.08494	66.09695	113.14
3.105295	60.99311	65.91924	137.13
3.105872	60.9977	65.8177	137.13
slope=0.746			

EHD Data for ICI Emkarate RL32H Under R-134a Pressure (~20 wt%)
(T=23 ± 0.5°C, P=3.84 bars; T=45°C, P=6.26 bars; T=65°C, P=6.74 bars)

Software version	2		
Lubricant name	ICI Emkarate RL32H		
Viscosity	0		
Oil refractive index	1.437		
Spacer type	Silica		
Ball diameter	0.01905		
Disc track radius	0.04465		
Trigger point	252		
Comments	ICI RL32H under R-134a pressure 4/27/98		
Temperature=Amb	45	65°C	Load=20N
M.R.=0.140 Trig. Pt.=388			
Avg. Band Top=237 Bottom=298			
Spacer Layer Film Thickness=460.1			
R.I.25°C=1.4510 45°C=1.4440 65°C=1.4370			
Disc #370			
Number of logged c	136		
Disc Speed (m/s)	Pot Temp (°C)	Lube Temp (°C)	Film (nm)
9.51E-03	24.26053	23.22746	3.743546
9.53E-03	24.25593	23.19192	3.743546
9.53E-03	24.28348	23.17669	3.604899
1.45E-02	24.24675	23.16653	4.575469
1.46E-02	24.26512	23.15638	4.575469
1.92E-02	24.27889	23.28839	5.407365
1.92E-02	24.26512	23.18685	5.615284
1.93E-02	24.2743	23.24778	5.407365
1.93E-02	24.26053	23.20208	5.615284
2.75E-02	24.27889	23.46103	7.382974
2.76E-02	24.26971	23.50673	7.071063
2.76E-02	24.28808	23.25285	7.209687
3.90E-02	24.26512	23.46611	11.23019
3.90E-02	24.26971	23.1056	11.64605
3.90E-02	24.25593	23.08529	11.64605
3.90E-02	24.25134	23.1056	11.64605
3.91E-02	24.27889	23.43057	11.23019
5.55E-02	24.26053	23.02944	13.24036
7.67E-02	24.04931	22.77557	18.30012
7.67E-02	24.26512	23.12592	15.8049
0.1078597	24.06768	22.77049	21.76556
0.1078678	24.0585	22.77049	21.55768
0.107873	24.06768	22.77557	22.66651
0.1079372	24.07227	22.76541	22.25073
0.1079519	24.07686	22.77557	22.04279
0.1503699	24.07227	22.76541	27.1713
0.1504772	24.06768	22.77557	27.03269
0.1505101	24.03554	22.76541	27.1713
0.2109946	24.07686	22.84157	34.94059
0.2110213	24.04931	22.77557	33.20028
0.2114944	24.06768	22.76033	33.58138
0.2945257	24.07686	22.75526	42.62383
0.2945943	24.08146	22.7451	42.41595
0.4124362	24.07227	22.79588	55.50979
0.4126796	24.07227	22.80095	55.44054
0.578306	24.08146	22.79588	69.22449
0.5784647	24.02636	22.81111	69.43225
0.8085116	24.10441	22.87712	84.99065
0.8090813	24.09064	22.88727	84.88678

EHD Data for ICI Emkarate RL32H Under R-134a Pressure (~20 wt%)
(T=23 ± 0.5°C, P=3.84 bars; T=45°C, P=6.26 bars; T=65°C, P=6.74 bars)

0.8093227	24.07227	22.86188	86.80056
0.8095768	24.07686	22.86188	86.80056
1.131204	24.1136	23.01421	103.649
1.131694	24.09982	22.95328	103.2683
1.584045	24.1136	23.02944	130.5026
1.585067	24.12278	23.05483	130.618
2.219508	24.12737	23.10053	160.3207
3.103678	24.22379	23.53212	200.181
3.103678	24.19625	23.52704	200.181
3.104152	24.19165	23.42041	200.3232
slope=0.701			
9.57E-03	44.12826	46.47742	1.871797
1.45E-02	44.23846	46.33525	2.407682
1.45E-02	44.29815	46.31495	2.417675
1.93E-02	44.7068	45.98491	3.119641
1.93E-02	44.72976	45.76149	3.535575
2.75E-02	43.92624	44.35502	4.367483
2.76E-02	43.99511	44.32964	4.367483
3.90E-02	41.97482	44.62413	5.823207
0.0390634	41.88298	44.57335	5.892579
3.91E-02	41.94267	44.62413	5.823207
5.55E-02	42.40183	44.93386	7.833531
5.56E-02	42.34214	44.9237	7.694878
7.65E-02	42.48448	44.93893	9.566553
7.67E-02	42.54876	44.94401	9.774475
7.67E-02	42.53499	44.95925	9.843827
0.1079011	42.8013	45.03541	12.89376
0.1079393	42.70028	44.94909	12.26991
0.1501962	42.95282	45.30959	15.59703
0.1505207	43.58187	45.70564	14.69594
0.1505368	42.93904	45.27913	15.52769
0.2111058	42.97578	45.38576	20.40252
0.2111773	43.08598	45.4213	20.44875
0.2946447	43.2375	45.467	25.50805
0.2947128	43.17321	45.49239	25.16152
0.4125164	43.44412	45.82243	31.71039
0.4125591	43.50381	45.90874	31.71039
0.5782002	43.37524	45.78688	40.33735
0.5785904	43.38902	45.75642	40.33735
0.8090253	43.32933	45.63456	51.42259
0.8092358	43.31556	45.59394	51.49187
1.1335	43.52217	45.65994	64.58398
1.134016	43.54054	45.76149	64.65322
1.586401	43.47626	45.61932	79.33549
1.586591	43.49922	45.65994	79.40475
2.221084	42.77834	44.80184	95.86014
2.221084	42.82426	44.77138	95.86014
2.221278	43.16862	45.1268	106.1595
2.222801	43.1824	45.15219	106.1279
2.224298	42.81048	44.80184	95.86014
3.104926	43.18699	45.03033	130.505
3.107255	43.17781	45.09634	130.7895
3.10805	43.19158	45.06587	130.505

EHD Data for ICI Emkarate RL32H Under R-134a Pressure (~20 wt%)
(T=23 ± 0.5°C, P=3.84 bars; T=45°C, P=6.26 bars; T=65°C, P=6.74 bars)

slope=0.721			
2.82E-02	60.2355	65.61459	2.949394
2.83E-02	60.22173	65.54351	2.949375
2.83E-02	60.24468	65.56889	2.949375
3.88E-02	59.22535	66.01064	3.742439
3.88E-02	59.28505	66.00048	3.742439
5.53E-02	59.36769	66.13758	4.989837
5.54E-02	59.2575	66.12743	4.989837
7.62E-02	59.79012	65.94971	6.549083
7.63E-02	59.7993	65.99541	6.583717
7.63E-02	59.70288	66.10204	6.791635
0.107736	59.65237	65.80246	8.835932
0.107852	59.56054	65.70091	9.251709
0.1497226	59.23913	65.53843	11.64238
0.2110438	59.11975	65.41657	15.49961
0.2112357	59.16107	65.45719	15.31485
0.2951322	59.26209	65.41149	19.7493
0.2951365	59.33096	65.47242	19.54145
0.4137947	59.3126	65.61459	25.36122
0.4138507	59.28045	65.6349	25.01481
0.5784624	59.0371	65.13223	30.54463
0.5788704	59.15648	65.117	30.23291
0.5789425	59.18403	65.19316	30.23291
0.808557	59.32637	64.77173	40.54908
0.8086847	59.24831	64.85804	40.37594
1.132048	59.44575	64.86819	54.69908
1.132918	59.46871	64.85804	54.69907
1.132973	59.43198	64.83266	54.69907
1.584813	59.9095	65.10684	69.09745
1.584852	60.19418	65.48766	67.5724
1.585748	59.81308	65.01037	68.85513
1.585997	59.73502	64.98498	70.4475
1.585997	59.78553	65.01037	70.4475
2.218807	60.22173	65.31502	83.8757
2.220036	60.23091	65.35564	83.8757
2.220232	60.19877	65.37595	83.8757
2.221576	60.20336	65.51305	81.79909
2.222757	60.20795	65.55874	81.79909
2.22378	60.19877	65.54351	81.79909
3.104811	60.19877	65.30486	105.054
3.105341	60.19418	65.27948	105.3308
3.106036	60.18959	65.30994	105.1578
slope=0.763			

EHD Data for ICI Emkarate RL32H Under R-134a Pressure (~40 wt%)
(T=22.5 ± 0.2°C, P=5.43 bars; T=45°C, P=8.46 bars; T=65°C, P=12.12 bars)

Software version	2		
Lubricant name	ICI Emkarate RL32H		
Viscosity	0		
Oil refractive index	1.437		
Spacer type	Silica		
Ball diameter	0.01905		
Disc track radius	0.04235		
Trigger point	123		
Comments	ICI RL32H under R-134a pressure 5/1/98		
Temperature=Ambi	65°C Load=20N		
M.R.=0.145 Trig. Pt.=123			
Avg. Band Top=237 Bottom=290			
Spacer Layer Film Thickness=492.6			
R.I. 25°C=1.4510 45°C=1.4440 65°C=1.4370			
Disc #382			
Number of logged c	125		
Disc Speed (m/s)	Pot Temp (°C)	Lube Temp (°C)	Film (nm)
1.06E-02	23.86106	22.47599	1.871308
0.0106043	23.87024	22.57247	1.732696
1.06E-02	23.85647	22.55723	1.871308
1.06E-02	23.87483	22.51661	1.732696
1.37E-02	23.86565	22.56739	2.079274
1.37E-02	23.87024	22.57247	2.079274
1.98E-02	23.68658	22.36936	2.910888
0.0198496	23.7279	22.26274	3.118818
1.99E-02	23.74627	22.34398	2.910888
2.76E-02	23.75086	22.34905	3.534633
2.77E-02	23.77382	22.36429	3.603957
4.00E-02	23.76923	22.34905	4.366295
4.00E-02	23.7325	22.31351	4.643502
5.55E-02	23.76923	22.36429	5.613764
5.55E-02	23.80137	22.37952	5.613764
5.56E-02	23.77841	22.34905	5.544481
7.71E-02	23.77841	22.45061	6.549328
7.71E-02	23.77841	22.45568	6.549328
7.71E-02	23.7325	22.44553	7.069095
7.71E-02	23.78759	22.44553	6.549328
0.10801	23.74627	22.43029	7.970029
0.1080774	23.69576	22.38968	8.039329
0.1082283	23.70495	22.37444	8.212584
0.1496839	23.77382	22.46584	9.841099
0.149771	23.76004	22.45061	9.771789
0.1499937	23.73709	22.45061	9.875753
0.2099662	23.75545	22.44553	12.33585
0.2099743	23.68658	22.46076	12.57835
0.2100356	23.73709	22.37952	12.40516
0.2947842	23.74627	22.46076	16.32031
0.2950337	23.7325	22.46584	16.28567
0.4125112	23.70495	22.24243	21.34377
0.4127403	23.70495	22.27289	21.41312
0.5780818	23.6774	22.30336	26.40156
0.5784243	23.65903	22.30843	26.05515

EHD Data for ICI Emkarate RL32H Under R-134a Pressure (~40 wt%)
(T=22.5 ± 0.2°C, P=5.43 bars; T=45°C, P=8.46 bars; T=65°C, P=12.12 bars)

0.8083549	23.71872	22.38968	32.08248
0.8085214	23.70495	22.37444	32.0132
1.130237	23.74627	22.44045	40.11808
1.130511	23.71872	22.40491	39.77176
1.586002	23.77382	22.50138	48.01417
1.58742	23.75086	22.47091	48.01417
2.221886	23.81055	22.53185	57.25974
2.223916	23.77382	22.542	57.67527
slope=0.652			
3.87E-02	43.47626	46.14231	2.61165
3.88E-02	43.4533	46.13215	2.61165
5.59E-02	43.20536	45.5127	3.342868
5.59E-02	43.02169	45.44669	3.203592
5.59E-02	42.70947	45.5787	3.064319
7.77E-02	42.72324	45.46192	4.387454
7.77E-02	42.70488	45.48223	4.387454
0.1072518	42.35592	45.60917	5.745454
0.1072871	42.62223	45.55839	5.641036
0.107311	42.37428	45.6701	5.78026
0.1073208	42.69569	45.58886	5.745451
0.1073817	42.60386	45.54824	5.15356
0.1073847	42.32837	45.5127	5.50175
0.1508489	42.73243	45.63963	7.730084
0.150851	42.74161	45.65487	7.730084
0.1508734	42.74161	45.64979	7.451568
0.1508747	42.57172	45.81227	7.242651
0.1508807	42.62223	45.8732	7.381923
0.1509094	42.63141	45.84274	6.824847
0.2112742	43.58646	45.52285	9.540637
0.2112884	43.71043	45.66502	9.471025
0.2114268	42.71406	45.48731	9.92366
0.2115332	42.75079	45.53808	9.819191
0.2951108	43.36606	45.23851	12.88306
0.2955586	42.67733	45.55839	13.16159
0.2956194	42.67273	45.52793	12.53489
0.2957006	42.72324	45.45177	12.39566
0.4138176	42.74161	45.58886	16.71272
0.413989	42.78293	45.55839	16.92159
0.414087	41.86921	45.82243	16.6431
0.5792337	42.81048	45.54316	22.14346
0.5794122	42.83803	45.56347	22.14346
0.5796618	41.38709	44.77645	22.00422
0.8099195	41.58453	44.5175	29.24459
0.8100488	43.48544	46.16769	29.55786
0.8101944	41.39628	44.58859	29.31423
0.8106596	43.52217	46.16769	29.66228
0.8106816	43.54972	46.21847	29.59266
1.135089	41.7085	44.4058	37.8067
1.135244	43.5635	46.40634	38.11993
1.135303	43.55432	46.35049	38.22436
1.136028	43.26046	45.72595	40.38206

EHD Data for ICI Emkarate RL32H Under R-134a Pressure (~40 wt%)
(T=22.5 ± 0.2°C, P=5.43 bars; T=45°C, P=8.46 bars; T=65°C, P=12.12 bars)

1.586753	42.5304	44.86277	47.34211
1.588004	42.23653	44.63936	47.41172
1.589654	43.55432	46.38603	48.10762
2.224557	42.91609	45.02525	57.54877
2.225721	42.72783	44.93893	57.57196
2.226738	43.61401	46.36572	57.64158
3.10802	43.69206	46.30479	69.12231
3.111806	43.69206	46.26417	69.1223
3.112266	43.69206	46.2794	69.12231
slope=0.782			
7.79E-02	57.87543	62.86766	2.716104
0.1073875	57.16833	62.94382	3.760726
0.1075317	59.06465	63.39064	3.969661
0.1076496	59.10138	63.47696	3.760728
0.1508552	59.79471	66.22897	5.083891
0.1508611	59.94623	66.20866	4.909777
0.1509988	59.86818	66.35083	5.014252
0.2112937	60.59364	66.18327	6.685585
0.2113494	61.2181	66.20866	6.476667
0.2113506	61.01148	66.20866	6.755192
0.2115903	60.55691	66.2442	6.61594
0.2953723	61.14922	65.38103	8.983588
0.295423	61.36044	66.00556	8.983588
0.2954613	61.28238	65.70599	9.262104
0.2954613	61.2732	65.7466	9.262104
0.4144427	58.08205	64.84281	12.11712
0.4144683	58.25653	64.99006	12.32604
0.4156177	60.44671	66.08173	12.81339
0.4157455	60.58905	66.36098	12.84821
0.5786323	57.61831	63.52266	16.39942
0.5786996	57.58616	63.82223	16.39942
0.5796898	57.65963	64.13703	15.66829
0.8088439	57.7285	63.46172	22.07384
0.8088956	58.004	63.41095	22.2827
1.13306	59.59268	64.71587	27.67824
1.133387	59.68451	64.76157	27.78265
1.133515	59.94164	65.00021	28.2003
1.58735	60.03806	65.01037	36.34494
1.587479	60.25846	65.10684	36.55377
2.225489	60.4559	64.90374	45.11496
2.225555	60.46508	64.96467	45.11496
2.226388	60.42376	65.03068	45.11496
3.109308	60.62119	64.80727	53.67509
3.110409	60.68547	64.75649	53.60546
3.111285	60.60283	64.83773	53.67509
slope=0.813			

EHD Data for Emkarate RL32H Under R-134a Pressure (~50 wt%)
(T=22.4 ± 0.2°C, P=5.91 bars; T=45°C, P=10.12 bars; T=65°C, P=15.22 bars)

Software version	2		
Lubricant name	ICI Emkarate RL32H		
Viscosity	0		
Oil refractive index	1.451		
Spacer type	Silica		
Ball diameter	0.01905		
Disc track radius	0.04335		
Trigger point	255		
Comments	ICI RL32H under R-134a pressure 5/4/98		
Temperature=Ambi	45	65°C	Load=20N
M.R.=0.140 Trig. Pt.=255			
Avg. Band Top=234 Bottom=290			
Spacer Layer Film Thickness=477.1			
R.I.25°C=1.4510 45°C=1.4440 65°C=1.4370			
Disc #386			
Number of logged c	114		
Disc Speed (m/s)	Pot Temp (°C)	Lube Temp (°C)	Film (nm)
1.40E-02	23.77841	22.42014	1.039853
0.0141552	23.82892	22.38968	1.109182
2.04E-02	23.80596	22.41506	1.386451
2.04E-02	23.80596	22.45061	1.455745
2.84E-02	23.83351	22.46584	2.079611
2.84E-02	23.783	22.45568	1.975636
3.95E-02	23.82433	22.40491	2.495557
3.95E-02	23.79219	22.48615	2.495557
3.96E-02	23.83351	22.47599	2.287597
5.54E-02	23.84728	22.48615	3.119421
5.54E-02	23.80596	22.48107	3.119421
0.0554553	23.84728	22.47599	3.119441
7.76E-02	23.81514	22.48615	3.84728
0.0776996	23.79219	22.48615	3.84728
7.77E-02	23.83351	22.50138	3.95129
0.1078655	23.81055	22.51154	4.783062
0.1078681	23.84269	22.43029	4.887033
0.1081348	23.8381	22.51154	4.887033
0.1506469	23.81973	22.54708	6.030795
0.1507532	23.82433	22.51154	5.892122
0.150838	23.83351	22.53185	5.961472
0.2109414	23.81973	22.59278	7.902339
0.2110717	23.80596	22.53692	8.040967
0.2936023	23.77382	22.57754	10.15501
0.2937434	23.82892	22.57247	10.29363
0.2942466	23.80137	22.45061	10.39759
0.4130299	23.69117	22.28812	13.74763
0.4132046	23.71413	22.29828	13.79382
0.4140469	23.79678	22.43029	13.23934
0.4144431	23.82433	22.45061	12.99678
0.5782273	23.7279	22.31859	17.53648
0.5784226	23.69576	22.30336	17.60577
0.5799778	23.81514	22.48107	16.98202
0.8084915	23.7279	22.37952	22.8035
0.8088781	23.7279	22.35921	22.73422

EHD Data for Emkarate RL32H Under R-134a Pressure (~50 wt%)
(T=22.4 ± 0.2°C, P=5.91 bars; T=45°C, P=10.12 bars; T=65°C, P=15.22 bars)

1.130265	23.75086	22.46584	28.1394
1.130442	23.73709	22.42522	28.27802
1.583356	23.75086	22.51154	35.13784
1.583608	23.75545	22.46076	34.99929
2.219237	23.79219	22.56739	43.5905
slope=0.734			
5.57E-02	43.85736	46.01029	1.559707
5.58E-02	43.91246	46.0306	1.559707
7.81E-02	43.63696	45.99506	2.287561
7.81E-02	43.77012	45.88335	2.079639
7.81E-02	43.84818	45.94936	2.287561
0.108337	44.96393	46.36064	2.703514
0.1084006	43.48085	45.61425	2.634197
0.1084358	43.14567	45.51777	2.703522
0.108468	43.22372	45.68533	2.703532
0.1085053	43.34769	45.6701	2.807519
0.1515676	44.5461	45.98998	3.847262
0.1517124	44.45427	45.7818	3.847262
0.21152	42.64059	44.66475	4.991063
0.2122152	42.57172	44.55812	4.991063
0.2948872	44.67466	45.54316	6.793269
0.2948942	44.1099	45.5787	6.654664
0.2949575	44.45427	45.74626	6.79327
0.2949953	44.73435	45.61932	6.654664
0.2950586	44.58742	45.70057	6.79328
0.2951572	43.8895	45.51777	6.654621
0.2951988	44.27519	45.70057	6.793305
0.2952192	42.92527	44.80184	6.446745
0.2952682	42.90231	44.76122	6.030802
0.2955271	42.82426	44.57335	6.516004
0.4144721	45.06495	46.02552	9.669824
0.4145762	45.12463	46.06615	9.912404
0.4146102	44.29356	45.36545	10.0857
0.4146343	44.44508	45.36545	9.912421
0.4152097	42.93904	44.3601	9.63516
0.4153062	43.16862	44.30932	9.704466
0.4153436	43.1273	44.18238	9.63516
0.5808258	44.82159	45.99506	13.62057
0.5809683	44.57365	45.88335	13.62057
0.5814261	43.58646	44.35502	13.23934
0.581589	43.37984	44.38549	13.30863
0.8118466	44.12826	45.47208	18.40274
0.8123755	44.22928	45.59394	18.29881
0.8132109	43.88491	44.59874	17.77902
0.8133004	44.1099	44.91862	18.02157
1.134467	44.06857	45.13188	23.6351
1.134695	44.25683	45.14711	23.6351
1.591857	44.87669	45.65487	29.73323
1.593349	44.83077	45.65487	29.73323
1.593572	44.88587	45.57363	29.73323

EHD Data for Emkarate RL32H Under R-134a Pressure (~50 wt%)
(T=22.4 ± 0.2°C, P=5.91 bars; T=45°C, P=10.12 bars; T=65°C, P=15.22 bars)

2.233277	44.8721	45.77165	38.15187
2.233317	44.88128	45.78688	38.04795
2.234149	44.8721	45.65487	38.15187
3.120164	44.90424	45.86304	48.64774
3.12088	44.89046	45.69549	48.64774
3.121692	44.89505	45.8275	48.64774
slop=0.874			
0.1009666	59.70288	64.54832	1.9358385
0.1513763	60.14826	64.91898	2.455782
0.2115964	65.00156	66.25436	3.535337
0.211888	64.97401	65.48792	3.535337
0.2946184	64.79952	65.41657	4.575119
0.2947213	64.72606	65.26933	4.575119
0.4149412	62.16855	64.61432	6.169445
0.4150179	62.49915	64.70572	6.308066
0.4150567	62.43027	64.70064	6.169388
0.4151246	62.27875	64.53816	6.215662
0.580381	62.3614	65.76184	9.149988
0.5806471	62.09968	65.50288	9.149988
0.8116924	61.59002	64.70572	13.20469
0.8118582	61.7599	65.05607	13.20469
1.134616	61.36503	64.55339	17.67505
1.135451	61.4339	64.86044	17.77902
1.589595	61.25024	64.99994	22.97673
1.590857	61.24565	64.74099	22.97672
2.227445	61.29615	64.83238	29.62926
2.228318	61.34207	64.78669	29.62926
2.229558	61.33748	64.82223	29.7332
3.116073	61.19514	64.92886	37.28577
3.116221	61.2732	64.84254	37.21646
3.119666	61.35585	64.88824	37.21646
slope=0.903			

EHD Data for ICI Emkarate RL68H Under R-134a Pressure (~10 wt%)
(T=23 ± 0.5°C, P=2.39 bars; T=45°C, P=3.71 bars; T=65°C, P=5.15 bars)

Software version	2		
Lubricant name	ICI Emkarate RL68H		
Viscosity	0		
Oil refractive index	1.441		
Spacer type	Silica		
Ball diameter	0.01905		
Disc track radius	0.0423		
Trigger point	295		
Comments	ICI RL68H under R-134a pressure 4/7/98		
Temperature=Ambie	45 65°C Load=20N		
M.R.=0.142 Trig. Pt.=318			
Avg.Band Top=241 Bottom=298			
Spacer Layer Film Thickness=466.0			
R.I.25°C=1.4536 45°C=1.4468 65°C=1.4406			
Disc #370			
Number of logged da	138		
Disc Speed (m/s)	Pot Temp (°C)	Lube Temp (°C)	Film (nm)
1.06E-02	23.98503	22.72479	14.11322
1.06E-02	23.96207	22.72479	14.73582
0.0106519	23.98044	22.74002	14.11322
1.38E-02	23.95289	22.76541	17.74493
1.38E-02	23.98044	22.7451	17.15695
0.013799	23.98044	22.77049	17.91784
1.99E-02	23.99422	22.81619	21.99888
1.99E-02	23.98962	22.80095	21.99888
2.77E-02	23.99422	22.82634	27.49766
2.77E-02	23.98503	22.84157	27.46308
3.86E-02	23.98044	22.9025	34.44827
3.86E-02	23.98503	22.89235	33.96416
3.86E-02	23.98044	22.89743	34.44827
5.41E-02	23.99881	22.92281	42.43545
5.41E-02	23.97585	22.91774	42.26257
7.73E-02	23.96667	22.92281	54.13985
7.74E-02	23.98044	22.92281	54.55467
0.1067795	23.98044	22.94312	67.89677
0.1069823	23.97585	22.95836	68.24239
0.1502135	23.97126	22.94312	85.03699
0.1502411	23.97126	22.92281	85.10612
0.2107017	23.96667	22.9482	103.7966
0.2107312	23.98044	22.94312	103.7966
0.2945413	23.96207	22.93297	132.7032
0.294589	23.94371	22.94312	133.0139
0.4120632	23.87943	22.89743	176.2409
0.412179	23.88402	22.88727	176.2409
0.5782726	23.90238	22.93805	219.6635
0.5783451	23.8932	22.92281	219.9472
0.5785348	23.88402	22.92789	220.2309
0.8084629	23.90697	22.90758	272
0.8085903	23.91616	22.91266	272
1.131749	23.93452	22.93805	341.6517
1.132121	23.92993	22.9025	342.0119
1.588259	23.93452	22.99898	416.5512
1.588952	23.93452	22.98374	416.6713
1.588987	23.93452	22.90758	416.5512

EHD Data for ICI Emkarate RL68H Under R-134a Pressure (~10 wt%)
(T=23 ± 0.5°C, P=2.39 bars; T=45°C, P=3.71 bars; T=65°C, P=5.15 bars)

2.219218	23.81973	22.78572	504.7957
2.220313	23.81055	22.74002	504.5775
2.221081	23.80596	22.79588	503.8499
3.112607	23.8381	22.92281	572.226
3.114205	23.84728	23.05483	571.0623
3.114685	23.84269	23.0396	571.5714
slope=0.664			
1.06E-02	42.67273	45.16742	7.821002
0.0106519	42.67273	45.15727	7.821002
1.07E-02	42.60845	45.12173	7.821002
1.37E-02	43.3982	45.91382	9.593617
1.38E-02	43.30637	45.76657	9.072258
1.38E-02	43.31096	45.7818	9.072258
1.99E-02	43.59105	45.61932	11.41527
1.99E-02	43.65074	45.72595	11.51906
1.99E-02	43.63696	45.81227	11.36387
2.76E-02	43.32474	45.24359	14.11322
0.0276533	42.91609	44.89324	14.1824
2.78E-02	43.33851	45.20805	14.11322
3.85E-02	42.44316	44.74091	17.50282
3.86E-02	42.34214	44.75615	17.71032
5.40E-02	42.33755	44.98463	22.20643
5.41E-02	42.31918	44.96432	22.41395
5.41E-02	42.33755	44.88308	22.48311
7.73E-02	42.44316	45.18266	28.56968
0.077315	42.46611	45.19281	29.26131
7.74E-02	42.41561	45.13696	28.84636
0.1067522	42.53958	45.32991	35.41644
0.106847	42.59008	45.33498	35.27813
0.1500685	42.92068	45.56855	43.35364
0.150234	42.92986	45.54824	43.69937
0.2105181	42.98037	45.45684	54.76208
0.2106646	43.00333	45.45177	54.55467
0.2941616	43.03547	45.55331	69.90129
0.2944183	43.03088	45.55331	69.90129
0.4125709	42.70947	45.04049	86.97199
0.4128326	42.73243	45.05572	87.11019
0.5782778	42.71406	44.97448	108.4598
0.5785295	42.71865	44.98971	108.3216
0.808471	42.69569	45.06079	137.0537
0.8088213	42.70947	45.04556	136.6394
1.131437	42.72783	45.01002	170.0885
1.131936	42.70947	45.00494	169.5708
1.132616	42.74161	45.03541	169.5018
1.5893	42.89772	45.24359	221.6287
1.590608	42.87476	45.20805	221.6287
2.222108	42.95741	45.38068	270.7028
2.222756	42.93904	45.34514	270.9864
3.111053	42.98955	45.47715	320.9792
3.11219	43.06761	45.6244	320.5068
3.112354	42.97578	45.39083	320.8848
slope=0.664			

EHD Data for ICI Emkarate RL68H Under R-134a Pressure (~10 wt%)
(T=23 ± 0.5°C, P=2.39 bars; T=45°C, P=3.71 bars; T=65°C, P=5.15 bars)

1.06E-02	58.70651	64.7768	5.286857
0.0106519	58.7111	64.76157	5.286857
1.38E-02	59.58809	65.39118	6.194353
0.013793	59.35392	65.6349	5.775497
1.38E-02	59.61564	65.36579	6.194353
1.39E-02	59.43657	65.70599	6.124535
1.98E-02	59.13352	65.04083	7.590505
1.99E-02	59.00955	64.78696	7.590498
1.99E-02	58.95905	64.69048	7.241457
2.00E-02	59.15189	65.0256	7.590505
2.76E-02	59.76257	65.44196	9.265826
2.76E-02	59.76716	65.44704	9.265826
3.85E-02	59.58809	65.51305	11.35994
3.86E-02	59.62023	65.51305	11.35994
5.41E-02	59.51463	65.46735	14.08224
5.41E-02	59.48708	65.42673	14.08224
7.74E-02	59.56054	65.73645	17.92119
7.75E-02	59.53758	65.71107	18.16548
0.1068468	59.64778	65.98017	21.89951
0.1070571	59.6386	65.94971	21.93442
0.1503388	59.67074	66.07157	27.90144
0.1503961	59.67533	66.08173	27.69211
0.1506955	59.6891	66.11726	27.69212
0.2107565	59.58809	65.84816	34.39142
0.2109133	59.57891	65.87862	34.60077
0.2942772	59.56513	65.55874	43.25308
0.2943209	59.57431	65.60951	43.28797
0.2947255	59.5835	65.71107	43.18331
0.4124586	59.4733	65.02052	54.69481
0.412592	59.47789	65.02052	54.69478
0.578088	59.51463	65.18808	67.98296
0.5782697	59.45953	64.95959	70.74632
0.5786358	59.54676	65.01037	70.11861
0.578869	59.48708	64.95451	70.53708
0.5788705	59.55136	65.01037	67.98296
0.8080634	60.26305	66.16805	85.52207
0.8081199	60.26764	66.09188	85.45235
0.808597	59.72584	65.69076	87.06451
0.8088913	59.84522	65.59936	85.24319
0.8093517	59.78093	65.67552	87.06448
0.8094925	59.77175	65.56889	85.24319
1.131227	60.8875	67.1023	105.2965
1.131982	60.90128	67.11246	105.5056
1.132091	60.90587	67.14293	105.4011
1.590638	59.51921	65.26424	138.9579
1.590791	59.59268	65.35564	138.9579
2.224524	60.18499	65.84308	178.4735
2.224894	60.1253	65.78723	178.7599
3.113012	60.26305	65.94463	216.8477
3.115058	60.28601	65.89386	216.5613
slope=0.659			

EHD Data for ICI Emkarate RL68H Under R-134a Pressure (~15 wt%)
(T=23 ± 0.5°C, P=3.22 bars; T=45°C, P=5.29 bars; T=65°C, P=6.88 bars)

Software version	2		
Lubricant name	ICI Emkarate RL68H		
Viscosity	0		
Oil refractive index	1.441		
Spacer type	Silica		
Ball diameter	0.01905		
Disc track radius	0.0414		
Trigger point	395		
Comments	ICI RL68H under R-134a pressure 4/6/98		
Temperature=Ambie	45	65°C Load=20N	
M.R.=0.146 Trig. Pt.=395			
Avg. Band Top=244 Bottom=298			
Spacer Layer Film Thickness=482.9			
R.I.25°C=1.4536 45°C=1.4468 65°C=1.4406			
Disc #370			
Number of logged d	136		
Disc Speed (m/s)	Pot Temp (°C)	Lube Temp (°C)	Film (nm)
1.04E-02	24.12278	22.96343	10.73713
1.04E-02	24.12737	22.97359	10.84085
1.49E-02	24.109	23.00913	13.1232
1.50E-02	24.13196	22.9939	13.1232
1.94E-02	24.1136	22.99898	15.40554
1.95E-02	24.13196	23.00913	15.40554
0.028591	24.12737	23.01421	20.38477
2.86E-02	24.1136	23.02436	20.38477
2.86E-02	24.14574	23.01929	20.38478
3.92E-02	24.09982	23.07514	25.25996
3.92E-02	24.12278	23.01421	25.08708
3.93E-02	24.13655	23.04467	25.01793
3.93E-02	24.13655	23.05991	24.32643
0.0543836	24.15033	23.07006	30.75711
5.45E-02	24.11819	23.06499	30.68796
7.72E-02	24.1136	23.07006	38.43162
7.72E-02	24.13196	23.05991	38.50077
0.1075707	24.109	23.08022	48.52469
0.1075774	24.14115	23.08022	47.97168
0.15009	24.13655	23.08022	59.72208
0.1501344	24.13655	23.05483	59.79119
0.1504433	24.14574	23.08529	60.41325
0.2106123	24.13655	23.10053	74.3035
0.2106586	24.14115	23.09545	74.23441
0.2955624	24.05391	23.05483	92.69996
0.2956022	24.05391	23.01929	92.14729
0.2956601	24.03554	23.05991	92.21637
0.412327	24.06309	23.08022	117.4264
0.4126888	24.05391	23.07006	117.7025
0.5782895	24.09064	23.02436	147.6597
0.808962	24.10441	23.06499	195.3345
0.8092921	24.1136	23.08022	195.5237
1.130804	24.11819	23.08022	240.0173
1.13151	24.11819	23.01421	240.1592
1.131795	24.10441	23.08022	240.0173
1.588738	23.97126	22.72479	297.7911
1.5891	23.95289	22.7451	297.5549
2.217459	23.98962	22.89235	364.2451
2.218693	23.97126	22.92281	363.885

EHD Data for ICI Emkarate RL68H Under R-134a Pressure (~15 wt%)
(T=23 ± 0.5°C, P=3.22 bars; T=45°C, P=5.29 bars; T=65°C, P=6.88 bars)

3.112668	24.11819	23.12592	425.173
3.115027	24.14574	23.18177	424.3332
3.115924	24.14574	23.12084	424.813
slope=0.661			
1.04E-02	43.0722	45.52793	6.202054
1.04E-02	43.06302	45.58378	5.889291
1.04E-02	43.04006	45.39591	6.097777
0.0148931	42.28245	44.88816	7.453094
1.49E-02	42.31918	44.88308	7.453094
1.50E-02	42.26868	44.84246	7.557354
1.94E-02	42.64059	45.37053	8.808343
1.95E-02	42.51662	45.1268	8.599831
2.85E-02	42.77375	45.55839	11.24081
2.86E-02	42.78293	45.55331	11.24081
3.92E-02	42.91609	45.7158	13.91643
3.92E-02	42.92527	45.74626	13.46467
0.039242	42.96659	45.75642	13.29092
3.93E-02	42.89772	45.68025	13.88168
5.44E-02	43.03547	45.86812	17.14786
5.44E-02	43.01251	45.86812	17.14786
5.44E-02	43.02169	45.87828	17.35633
5.45E-02	43.01251	45.8275	17.07837
0.0771771	43.11812	46.03568	21.45625
7.72E-02	43.15026	46.0763	21.52575
7.72E-02	43.12271	46.06107	21.31729
0.1075685	43.20995	46.122	26.32019
0.1075688	43.19158	46.11184	26.32019
0.1076782	43.23291	46.12708	26.52868
0.150007	43.2375	46.16769	32.50389
0.1500148	43.2375	46.13723	32.46915
0.150019	43.16862	46.16769	32.46915
0.2104895	43.30178	46.26417	41.11844
0.2105876	43.32014	46.20324	41.01424
0.2953219	43.35688	46.00521	51.74614
0.2954482	43.34311	46.01537	51.81558
0.2955714	43.31556	46.04076	51.95449
0.4125307	42.57631	45.10142	66.33045
0.4128511	42.55335	45.09634	66.39994
0.5781467	42.57631	45.10142	82.02251
0.5788432	42.5809	45.06079	82.16139
0.8088387	42.7462	45.35022	101.9218
0.8091398	42.75079	45.38068	101.8871
0.8094159	42.59008	45.20297	102.0836
0.8096184	42.5809	45.20297	102.5695
1.131741	42.84721	45.56855	129.5053
1.132024	42.82885	45.48731	129.2971
1.587911	42.97119	45.76657	157.3905
1.587911	43.00333	45.78688	157.3905
1.588249	42.97119	45.72595	157.5986
2.223322	43.31096	46.09661	202.0771
2.223502	43.26046	46.11184	202.2672
2.223684	43.29259	46.07122	202.2672
3.110622	43.49004	46.30479	241.891
3.110761	43.36606	46.13723	240.181

EHD Data for ICI Emkarate RL68H Under R-134a Pressure (~15 wt%)
(T=23 ± 0.5°C, P=3.22 bars; T=45°C, P=5.29 bars; T=65°C, P=6.88 bars)

3.111221	43.37984	46.11692	239.991
3.111415	43.47626	46.27432	241.891
3.111559	43.49463	46.2794	241.701
slope=0.656			
0.010435	59.76257	66.46254	4.036509
1.50E-02	58.72028	64.81235	5.472306
1.50E-02	58.73865	64.79711	5.472306
1.94E-02	58.64222	64.7768	6.097777
0.0195005	58.63763	64.78188	6.097777
2.86E-02	58.74324	64.81235	7.765874
2.86E-02	58.74324	64.78696	7.765874
3.92E-02	58.84425	65.1627	9.329592
3.93E-02	58.85344	65.18808	9.329592
5.45E-02	58.982	65.37595	11.72728
5.45E-02	58.93608	65.34041	11.58827
7.72E-02	58.86262	65.03576	14.64607
0.0772361	58.88099	65.05099	14.6461
0.1075756	58.91313	65.08653	18.50294
0.1075837	60.20336	66.64533	18.56148
0.1076498	58.90395	65.06622	18.39871
0.1501582	59.00955	65.15762	22.56804
0.1502099	59.00496	65.18808	22.63751
0.2106894	59.12434	64.79711	27.57085
0.2108157	59.08761	64.87328	27.64033
0.2957185	59.82226	65.66537	36.11647
0.2958109	59.87736	65.69076	36.29087
0.2958883	60.10694	66.45746	35.17868
0.2960485	60.11153	66.35591	35.28287
0.4130876	60.02429	66.17312	44.66119
0.4134539	60.01051	66.2442	44.86954
0.5780368	59.04628	64.62447	57.16357
0.5789328	59.00955	64.62955	57.68443
0.8096864	59.23454	65.23378	72.99657
0.8101631	59.2529	65.39626	72.92715
1.132256	59.56513	65.52827	88.61761
1.132313	59.62023	65.59428	88.51351
1.588076	59.97378	66.09695	111.314
1.589324	60.01511	66.15789	111.1058
2.223316	59.91409	65.67045	143.1672
2.223471	59.92786	65.66537	143.1672
2.225018	59.9095	65.66537	143.1672
3.115943	60.02429	65.50797	174.5439
slope=0.656			

EHD Data for ICI Emkarate RL68H Under R-134a Pressure (~30 wt%)
(T=22.6 ± 0.2°C, P=5.10 bars; T=45°C, P=8.19 bars; T=65°C, P=11.71 bars)

Software version	2		
Lubricant name	ICI Emkarate RL68H		
Viscosity	0		
Oil refractive index	1.441		
Spacer type	Silica		
Ball diameter	0.01905		
Disc track radius	0.04305		
Trigger point	186		
Comments	ICI RL68H under R-134a pressure 4/9/98		
Temperature=Ambi	45	65°C Load=20N	
M.R.=0.141 Trig. Pt.=188			
Avg. Band Top=237 Bottom=298			
Spacer Layer Film Thickness=465.7			
R.I.25°C=1.4536 45°C=1.4468 65°C=1.4406			
Disc #370			
Number of logged d	153		
Disc Speed (m/s)	Pot Temp (°C)	Lube Temp (°C)	Film (nm)
1.09E-02	23.75086	22.45568	3.66439
1.09E-02	23.76004	22.44045	3.31868
1.10E-02	23.75086	22.45568	3.31868
0.0140254	23.78759	22.46584	4.148338
1.40E-02	23.76923	22.44045	4.148338
2.03E-02	23.76923	22.51154	5.185387
2.03E-02	23.80596	22.52677	4.978012
2.03E-02	23.80137	22.50646	5.185387
2.82E-02	23.80137	22.56231	7.25954
0.0282086	23.79678	22.55723	6.637293
2.83E-02	23.80596	22.57754	7.052111
3.93E-02	23.82433	22.5877	8.676764
3.93E-02	23.81514	22.5877	8.676764
3.94E-02	23.80596	22.58262	8.480887
5.51E-02	23.81514	22.56231	10.5779
5.51E-02	23.81055	22.58262	10.57791
0.0551033	23.81514	22.59785	10.47419
7.71E-02	23.81973	22.60293	12.99752
7.72E-02	23.81973	22.56739	13.04359
7.73E-02	23.80137	22.60293	13.27405
0.1072221	23.83351	22.63847	16.66134
0.1072873	23.81973	22.64355	16.38485
0.1497927	23.8381	22.65878	20.73966
0.1498465	23.81514	22.66386	20.80881
0.1499259	23.81973	22.68925	20.94703
0.2113245	23.83351	22.71464	27.23695
0.2114156	23.81514	22.67909	27.23694
0.2946526	23.78759	22.80603	34.14828
0.2948085	23.81973	22.70448	33.80273
0.2951638	23.8381	22.72987	33.80273
0.413298	23.783	22.77049	42.51009
0.4134429	23.77841	22.78064	42.5792
0.5775205	23.79219	22.78064	54.00301
0.5778949	23.79219	22.77557	54.04907
0.8079652	23.81055	22.77049	68.76361

EHD Data for ICI Emkarate RL68H Under R-134a Pressure (~30 wt%)
(T=22.6 ± 0.2°C, P=5.10 bars; T=45°C, P=8.19 bars; T=65°C, P=11.71 bars)

0.8083865	23.80596	22.77049	69.10905
1.131655	23.80596	22.75526	85.96106
1.132227	23.82433	22.77049	86.44442
1.5884	23.61771	22.34905	109.7318
1.588637	23.58557	22.31351	109.8353
2.218916	23.62689	22.49122	138.8232
2.219949	23.61771	22.43029	138.7542
3.109698	23.75086	22.81619	178.4833
3.111043	23.75086	22.83142	178.4833
3.112829	23.74168	22.82126	178.5778
slope=0.696			
1.08E-02	42.22276	45.30452	2.348058
1.09E-02	42.23653	45.30452	2.348058
0.0140254	42.26408	45.36037	2.922036
1.40E-02	42.31459	45.38576	2.922036
2.03E-02	42.14011	45.05064	3.617726
2.03E-02	42.11256	45.05064	3.617726
2.82E-02	41.78656	44.97956	4.591696
2.82E-02	41.80952	44.99479	4.591696
3.93E-02	41.78197	45.2639	5.809134
0.0393244	41.7682	45.25882	5.890294
3.93E-02	41.7131	45.2639	5.809134
5.51E-02	42.13552	45.29436	7.722253
5.51E-02	41.91972	45.35022	7.583115
5.51E-02	42.16766	45.25882	7.304854
5.51E-02	41.92431	45.31975	8.139637
5.51E-02	41.96563	45.08619	7.304725
5.51E-02	41.96563	45.04556	7.304725
5.52E-02	42.12634	45.25374	7.513586
7.71E-02	41.96104	45.36037	10.01792
7.72E-02	41.97022	45.36545	10.01792
7.72E-02	42.23653	45.54316	9.8788
7.72E-02	42.20898	45.55331	9.600561
0.1071418	42.23653	45.62948	12.62651
0.1071891	42.27327	45.64979	12.80044
0.107217	42.06205	45.46192	11.68747
0.1072574	42.04369	45.40099	12.17437
0.107282	42.19062	45.61425	12.31347
0.149746	42.27786	45.60409	15.44372
0.1499126	42.27786	45.64979	15.44372
0.150038	42.26868	45.59901	15.65242
0.2112993	42.18143	45.55839	19.93025
0.2113664	42.28704	45.73103	20.24324
0.2113721	42.25949	45.76149	20.24324
0.2114048	42.1998	45.54316	19.82595
0.2114424	42.18143	45.5787	20.03458
0.2115189	42.28704	45.76149	20.24324
0.2950726	41.78197	45.03033	23.91924
0.2951452	41.79115	45.0151	23.53911
0.2952788	42.26868	45.72595	25.80743

EHD Data for ICI Emkarate RL68H Under R-134a Pressure (~30 wt%)
(T=22.6 ± 0.2°C, P=5.10 bars; T=45°C, P=8.19 bars; T=65°C, P=11.71 bars)

0.2954493	42.30541	45.74626	25.66832
0.2955483	42.29163	45.73611	25.66832
0.4137018	42.29623	45.54824	33.22571
0.4137677	41.79574	45.03541	31.1074
0.4138292	41.78197	45.0151	31.38383
0.4139088	42.27327	45.63456	33.10981
0.5780723	41.81411	44.98463	40.33336
0.5782643	41.84166	44.94909	40.29881
0.8090059	41.94727	44.97448	51.90727
0.8090461	41.90594	44.91355	51.63087
1.13321	42.71865	45.90366	64.18153
1.133795	42.74161	45.9189	63.97301
1.135195	42.70028	45.8732	63.97301
1.590194	42.79211	46.05599	81.14026
1.590896	42.77375	46.00521	81.27924
2.224525	42.86558	46.02552	102.1243
2.225206	42.87017	46.04076	102.1243
2.225553	42.89772	46.03568	102.1242
3.11364	42.93445	45.94429	125.7757
3.114321	42.96659	45.9646	125.8799
3.115968	42.94823	45.97983	126.0882
slope=0.707			
1.09E-02	58.2198	66.40668	1.88753
1.09E-02	58.15093	66.25436	1.712988
1.09E-02	58.17389	66.34576	1.88753
1.40E-02	57.78819	65.32517	2.201685
1.41E-02	57.7285	65.35564	2.201685
2.03E-02	57.19129	64.86819	2.690377
2.04E-02	57.06731	64.84281	2.934727
2.82E-02	57.06273	65.08653	3.458323
2.82E-02	56.91579	64.84789	3.667737
2.83E-02	57.18211	65.06114	3.458323
3.93E-02	57.21884	65.29471	4.505439
3.93E-02	57.23261	65.34548	4.505439
5.52E-02	57.33363	65.55874	5.412991
5.52E-02	57.33363	65.53843	5.552606
5.52E-02	57.29689	65.57397	5.552606
0.0772493	57.72391	66.17312	7.437447
7.73E-02	57.71014	66.17312	6.66955
7.73E-02	57.83411	65.77708	7.088418
0.1072767	57.65504	65.49273	8.903439
0.1073482	57.5127	65.6349	8.624223
0.1073519	57.59076	65.50797	8.90344
0.1500718	57.31526	65.18301	11.83524
0.1500853	57.37036	65.04083	11.90505
0.1503935	57.3474	65.14239	11.83524
0.2116705	57.20047	65.23378	15.54638
0.2118175	57.21884	65.21854	15.28657
0.2120901	57.25098	65.15254	16.11634
0.2951987	57.48515	65.19823	19.58318

EHD Data for ICI Emkarate RL68H Under R-134a Pressure (~30 wt%)
(T=22.6 ± 0.2°C, P=5.10 bars; T=45°C, P=8.19 bars; T=65°C, P=11.71 bars)

0.2955492	57.41168	65.17285	19.30398
0.4140812	57.55861	65.26424	24.32921
0.4147868	57.47137	65.29471	24.18963
0.5786378	57.52647	65.15254	31.72691
0.5787644	57.56321	65.05099	31.8316
0.8103812	58.15552	66.00048	40.1007
0.8104085	58.12797	66.0868	40.1007
1.135971	58.70651	65.88371	50.54593
1.136108	58.22439	65.94971	50.98511
1.136226	58.23817	65.90401	51.19442
1.593272	58.3805	65.73645	65.52992
1.593463	58.80293	65.85831	66.17197
1.593592	58.33918	65.75677	65.63454
1.593985	58.40805	65.73138	65.5648
2.22696	58.96363	65.6806	82.35226
2.228833	59.02333	65.54858	82.422
2.229701	58.8764	65.70599	82.35226
3.118012	59.23913	65.38611	101.5962
3.119572	59.24831	65.37595	101.7356
3.121449	59.17944	65.36579	101.5962
slope=0.720			

EHD Data for ICI Emkarate RL68H Under R-134a Pressure (~50 wt%)
(T=22.4 ± 0.2°C, P=6.05 bars; T=45°C, P=10.39 bars; T=65°C, P=15.98 bars)

Software version	2		
Lubricant name	ICI Emkarate RL68H		
Viscosity	0		
Oil refractive index	1.441		
Spacer type	Silica		
Ball diameter	0.01905		
Disc track radius	0.0424		
Trigger point	389		
Comments	ICI RL68H under R-134a pressure 7/8/98		
Temperature=Ambie	45	65°C Load=20N	
M.R.=0.136 Trig. Pt.=389			
Avg. Band Top=237 Bottom=287			
Spacer Layer Film Thickness=467.1			
R.I.25°C=1.4536 45°C=1.4468 65°C=1.4406			
Disc #408			
Number of logged da	132		
Disc Speed (m/s)	Pot Temp (°C)	Lube Temp (°C)	Film (nm)
0.0105016	23.66362	22.25258	1.510445
1.05E-02	23.71413	22.3846	1.510445
0.013596	23.783	22.40998	1.71814
1.37E-02	23.74168	22.2475	1.925912
1.98E-02	23.72331	22.46076	2.341366
1.98E-02	23.79219	22.42522	2.445255
2.76E-02	23.82433	22.47091	2.860753
2.76E-02	23.82892	22.42522	2.860743
2.78E-02	23.79219	22.45061	2.75684
3.86E-02	23.79219	22.39475	3.795547
3.87E-02	23.80137	22.42014	3.795547
5.41E-02	23.84728	22.50138	4.626513
5.41E-02	23.84269	22.51661	4.211071
5.41E-02	23.80596	22.52169	4.488032
7.75E-02	23.86565	22.51661	6.080669
7.75E-02	23.85647	22.51154	6.080662
0.106979	23.85188	22.55723	7.638645
0.1070528	23.85188	22.54708	7.327076
0.1071114	23.81973	22.542	7.673254
0.1505372	23.86565	22.542	9.542779
0.1506271	23.86106	22.55215	9.335046
0.2111821	23.85188	22.53692	11.20452
0.2113724	23.85188	22.55723	11.34301
0.2954201	23.84269	22.52677	13.55862
0.2954448	23.84728	22.53692	13.69711
0.413656	23.85647	22.56739	17.15886
0.4136869	23.8381	22.53185	17.2281
0.5784834	23.82433	22.53692	21.97048
0.5784962	23.86106	22.542	21.24353
0.5789738	23.85647	22.50646	21.55509
0.8082054	23.68658	22.23227	27.52161
0.8084326	23.6774	22.25766	27.41778
1.13195	23.6774	22.29828	33.30159
1.132048	23.67281	22.30336	33.33619
1.585621	23.71413	22.40491	39.98084
1.586331	23.71413	22.36936	39.98084

EHD Data for ICI Emkarate RL68H Under R-134a Pressure (~50 wt%)
(T=22.4 ± 0.2°C, P=6.05 bars; T=45°C, P=10.39 bars; T=65°C, P=15.98 bars)

2.221704	23.75086	22.51154	47.85965
slope=0.654			
1.98E-02	45.29911	46.09661	1.517726
1.99E-02	45.35421	46.11692	1.308985
0.0199725	45.32207	46.10169	1.517726
2.75E-02	44.37621	45.93413	1.726496
2.77E-02	44.72517	45.6244	1.726496
2.77E-02	44.9823	45.93921	2.004782
3.86E-02	44.53691	45.19281	2.248358
3.86E-02	44.58742	44.95925	2.491908
3.87E-02	44.44967	45.15727	2.248358
5.42E-02	44.22469	45.2182	2.770205
5.43E-02	43.90787	44.82215	2.874565
5.43E-02	43.90787	45.44161	3.187717
7.76E-02	44.07775	45.16235	3.605231
7.76E-02	44.17418	45.27405	3.674787
7.76E-02	44.06398	45.19789	4.092268
7.76E-02	44.00429	45.16235	3.605231
0.1072588	43.96756	45.13696	4.648908
0.1072878	43.99511	45.08619	4.718487
0.1073112	43.93082	45.10649	5.251916
0.107485	43.95378	45.14711	5.066394
0.1508009	44.14204	45.26897	5.692585
0.1508039	44.11908	45.24359	6.249206
0.150848	44.22469	45.19789	6.318778
0.2115181	44.25683	45.21312	7.779926
0.2116615	44.24764	45.06587	7.571212
0.2118014	44.26142	45.05064	7.988673
0.2956305	44.23387	45.14204	9.936795
0.2956531	44.27979	45.16742	10.14552
0.295775	44.26601	45.18266	10.35426
0.2957834	44.28897	45.19281	10.58617
0.4138717	43.75634	44.89832	13.76337
0.4142074	43.84359	44.84246	13.51989
0.4142086	43.64156	45.24359	14.18079
0.4144747	43.50381	45.13188	14.04168
0.4155358	44.22469	45.27405	13.20674
0.5792877	44.01347	44.94909	18.42454
0.5794067	43.99052	44.89832	18.42454
0.579678	43.04465	44.49212	18.63325
0.5799	43.10893	44.42611	18.56368
0.5812971	44.29356	45.27405	18.00715
0.8095509	43.51758	44.5632	23.64192
0.8102765	44.08694	44.95417	22.87676
0.8105295	42.83344	44.27886	22.66808
0.8106995	43.04465	44.23316	22.70286
0.8128815	44.23846	45.29436	22.5289
0.8129637	44.15122	45.18773	22.66804
0.813237	45.20269	45.54824	23.36368
1.138404	44.31652	45.26897	28.85897
1.138557	44.31652	45.26897	28.65028

EHD Data for ICI Emkarate RL68H Under R-134a Pressure (~50 wt%)
(T=22.4 ± 0.2°C, P=6.05 bars; T=45°C, P=10.39 bars; T=65°C, P=15.98 bars)

1.588043	44.20632	45.05572	34.91022
1.58865	44.22928	45.05064	34.56248
1.588876	43.67829	44.73584	35.43186
1.589646	43.78389	44.75107	35.11883
1.594667	44.56446	45.5127	33.06926
2.2307	44.15581	45.1268	41.20657
2.233012	44.1604	45.24359	41.20657
2.234857	44.15581	45.2639	41.20657
slope=0.736			
0.1072878	61.99511	65.08619	3.218487
0.1073112	61.93082	65.10649	3.251916
0.1510915	61.78745	64.7311	4.092243
0.1511894	61.82418	64.81235	4.022674
0.2116503	62.05836	65.17285	4.648908
0.2117967	62.0354	65.11192	5.170749
0.2118396	62.19151	64.83266	5.13594
0.2120483	62.17315	64.91389	5.170738
0.2956158	62.46241	65.15254	6.318825
0.2957682	61.42472	64.67017	7.153728
0.295822	62.32467	65.05607	6.318798
0.2958556	61.19973	64.47723	7.223309
0.2958926	61.42931	64.63463	7.153727
0.2959251	62.43486	65.20332	6.423165
0.2961329	61.86551	64.7311	7.153784
0.2962862	61.97571	64.69556	6.94503
0.2963049	61.99407	64.84281	7.014615
0.4141123	62.57261	65.25916	9.009132
0.4142499	62.59557	65.15254	8.893165
0.4144091	62.4716	65.14239	8.823576
0.4146228	60.43753	64.79176	9.728077
0.4148178	60.53395	64.62421	9.449758
0.4160503	62.68281	65.08653	9.032342
0.4163019	62.50374	64.95451	9.171481
0.5817783	61.2181	63.8273	12.16323
0.5821255	62.52211	64.70572	12.58062
0.810534	62.3614	64.70572	16.65056
0.810774	62.51751	64.9342	16.65056
0.812669	62.15478	64.63971	16.96358
0.8129217	62.22824	64.63971	17.10274
1.138159	61.98489	64.58385	21.27677
1.13858	62.02162	64.60416	21.41587
1.59468	61.84255	64.54832	26.49398
1.594731	61.87928	64.51277	26.6331
2.232374	61.77368	64.36044	32.26717
2.232854	61.8196	64.53308	32.40629
2.233317	61.38799	64.48738	32.51064
3.122949	61.67725	64.68033	39.7091
3.123667	61.66348	64.51277	39.81342
3.125177	61.69562	64.65495	39.50043
slope=0.778			

EHD Data for Mobil EAL Arctic 68 Under R-134a Pressure (~10 wt%)
(T=23.0 ± 0.5°C, P=2.26 bars; T=45°C, P=3.50 bars; T=65°C, P=4.88 bars)

Software version	2		
Lubricant name	Mobil EAL Arctic 68		
Viscosity	0		
Oil refractive index	1.4384		
Spacer type	Silica		
Ball diameter	0.01905		
Disc track radius	0.04437		
Trigger point	454		
Comments	Mobil Arctic 68 under R-134a pressure 3/2/98		
Temperature=Ambi	45	65°C	Load=20N
M.R.=0.143 Trig. Pt.=428			
Avg. Band Top=230 Bottom=298			
Spacer Layer Film Thickness=478.9			
R.I.25°C=1.4516 45°C=1.4445 65°C=1.4384			
Disc #368			
Number of logged d	139		
Disc Speed (m/s)	Pot Temp (°C)	Lube Temp (°C)	Film (nm)
9.56E-03	24.46715	23.1513	13.27328
1.44E-02	24.4947	23.16146	17.63687
1.45E-02	24.48551	23.197	17.42915
1.45E-02	24.49929	23.17161	17.74079
1.45E-02	24.4901	23.16146	17.49839
1.92E-02	24.4901	23.13099	20.48084
1.93E-02	24.4947	23.19192	20.48084
1.93E-02	24.50388	23.21223	20.65398
0.0274711	24.50847	23.20716	27.46728
2.75E-02	24.4947	23.21223	27.36339
3.89E-02	24.4947	23.21223	32.25782
3.89E-02	24.4901	23.22746	31.98084
3.89E-02	24.50847	23.197	32.25782
5.52E-02	24.4947	23.24778	38.43618
5.52E-02	24.4947	23.21223	37.67458
7.63E-02	24.50388	23.26301	49.23606
7.64E-02	24.50388	23.21731	48.75145
0.1071738	24.4947	23.36456	60.65701
0.107271	24.4901	23.34933	60.657
0.1072848	24.4947	23.34425	61.97205
0.1073099	24.48551	23.34425	61.69519
0.1073374	24.4901	23.3544	59.68802
0.1495607	24.4901	23.33409	76.02043
0.1495984	24.48092	23.37471	80.58728
0.1496624	24.48551	23.33917	76.91999
0.1496673	24.45337	23.37471	78.78826
0.1499555	24.4396	23.36964	80.79485
0.2113786	24.45796	23.29855	97.13888
0.2114675	24.46715	23.31378	97.60638
0.2114775	24.50388	23.31886	96.9838
0.2114917	24.48551	23.28332	97.46804
0.2944798	24.43041	23.27824	125.2876
0.2947031	24.49929	23.25285	125.6333
0.2947142	24.48092	23.27824	124.4578
0.4137634	24.48092	23.29855	159.8534

EHD Data for Mobil EAL Arctic 68 Under R-134a Pressure (~10 wt%)
(T=23.0 ± 0.5°C, P=2.26 bars; T=45°C, P=3.50 bars; T=65°C, P=4.88 bars)

0.4137634	24.47633	23.28839	159.8534
0.4139858	24.4947	23.27824	159.5079
0.5778697	24.4901	23.28839	197.0163
0.578427	24.47633	23.28332	196.9127
0.5784774	24.50388	23.28839	196.7745
0.8095933	24.1136	22.76541	281.0398
0.8097785	24.12278	22.77557	280.3774
1.133779	24.13196	22.84157	356.4432
1.134587	24.10441	22.85173	356.3231
1.587517	24.12737	22.88727	439.2381
1.58759	24.12737	22.9025	439.2381
1.587762	24.12737	22.93805	439.2381
2.219507	24.14115	23.03452	542.4867
2.222491	24.08605	23.07006	542.4867
2.223183	24.13655	23.02436	542.7053
3.103974	24.36154	23.95863	637.2905
3.107713	24.41205	24.11095	636.3489
3.108321	24.36154	23.96878	636.8625
3.109921	24.4396	24.07541	635.493
3.110125	24.35236	23.90277	637.5474
slope=0.685			
9.53E-03	43.01251	45.29944	7.398017
9.62E-03	43.06302	45.27913	7.398017
1.45E-02	42.95282	45.10649	10.14485
1.45E-02	42.90691	45.04556	10.14485
1.93E-02	42.73701	44.92878	12.62532
1.93E-02	42.75538	44.92878	12.25319
2.75E-02	44.01347	46.17277	14.84643
2.75E-02	43.95378	46.06615	14.54249
2.75E-02	43.95378	46.10677	14.54249
3.88E-02	42.56254	45.02525	18.28366
3.88E-02	42.57631	45.0151	18.28366
5.51E-02	42.75998	45.4213	24.85496
5.52E-02	43.45789	45.79704	24.18609
5.52E-02	42.75538	45.40607	24.85494
5.52E-02	43.4533	45.82243	24.25535
7.62E-02	42.95282	45.61425	29.7375
7.63E-02	42.95282	45.6244	29.7375
0.1071733	43.1273	45.86812	36.28171
0.1072439	43.13189	45.86812	36.28171
0.149373	43.34311	45.94936	44.79863
0.1494143	43.32933	45.97475	44.17549
0.2111104	43.41198	45.99506	55.07982
0.2111955	43.38902	46.00014	55.07982
0.293928	43.46249	45.98491	68.40503
0.2940077	43.51758	45.94936	68.26662
0.4135479	43.02169	45.21312	84.12493
0.4137091	42.99874	45.22328	84.05575
0.5779279	43.02169	45.28928	108.8116
0.5781899	42.962	45.27913	108.8116

EHD Data for Mobil EAL Arctic 68 Under R-134a Pressure (~10 wt%)
(T=23.0 ± 0.5°C, P=2.26 bars; T=45°C, P=3.50 bars; T=65°C, P=4.88 bars)

0.8088768	43.0171	45.32483	135.0295
0.8096673	43.0171	45.30959	135.0295
1.133999	43.0722	45.23343	168.6279
1.134503	43.08598	45.27913	168.5587
1.584434	43.52217	45.94429	223.4882
1.585546	43.53136	45.95952	223.3935
2.22382	43.20995	45.46192	269.0684
2.22404	43.28341	45.52793	269.0684
2.224167	43.25586	45.533	269.0684
3.107852	43.37524	45.61425	329.2458
3.108353	43.37984	45.65487	328.962
3.109139	43.36147	45.60409	329.8134
slope=0.652			
9.53E-03	43.01251	45.29944	3.898017
1.45E-02	59.92327	65.98017	5.179612
1.93E-02	60.43753	66.02587	6.501091
1.93E-02	60.35029	65.74153	6.664168
2.75E-02	59.40902	65.20839	8.852969
2.76E-02	59.39983	65.18808	9.296886
3.89E-02	60.10694	66.06142	12.27556
3.89E-02	60.09776	66.06649	12.27556
3.89E-02	59.85899	65.85831	12.05263
5.52E-02	59.24831	64.72095	14.69993
5.52E-02	59.23454	64.72603	14.69993
7.62E-02	59.05088	64.75141	18.19351
7.63E-02	58.97741	64.72095	18.50519
7.63E-02	59.00955	64.72095	18.53983
0.1071018	59.17944	64.98498	22.80375
0.1072564	59.17485	64.95451	22.59594
0.1072564	59.19321	64.94436	22.59594
0.149461	59.90031	65.24901	28.64145
0.1495342	59.94164	65.28455	28.29516
0.2111538	60.02888	65.2287	35.52769
0.2112088	59.99674	65.25916	35.52769
0.2939643	60.1253	65.28455	40.66761
0.2941871	60.08857	65.33533	40.87533
0.4133258	59.82685	65.14239	51.26517
0.4134392	59.84063	65.13223	51.33438
0.5779241	59.7993	65.20332	65.59358
0.5780679	59.81308	65.12207	66.00883
0.8088859	59.88195	65.21854	85.08807
0.8093242	59.91409	65.12207	84.88046
1.133925	59.97378	65.3201	106.3266
1.134395	59.96919	65.19823	106.2574
1.587954	60.02888	65.41657	134.8882
1.588129	60.07021	65.46735	135.0957
2.220699	60.25387	65.35056	169.6244
2.221338	60.19418	65.31502	178.2999
2.221935	60.2906	65.34548	170.0736
2.22272	60.10694	65.36579	168.0694

EHD Data for Mobil EAL Arctic 68 Under R-134a Pressure (~10 wt%)
(T=23.0 ± 0.5°C, P=2.26 bars; T=45°C, P=3.50 bars; T=65°C, P=4.88 bars)

2.223307	60.1804	65.30994	178.4421
2.224524	60.19418	65.37595	170.3501
2.248662	60.20795	65.2744	178.1578
3.110257	60.27223	65.26933	217.2794
3.110562	60.24928	65.25916	217.5161
3.111068	60.24928	65.28455	217.3741
slope=0.655			

EHD Data for Mobil EAL Arctic 68 Under R-134a Pressure (~15 wt%)
(T=23.0 ± 0.5°C, P=3.22 bars; T=45°C, P=5.15 bars; T=65°C, P=6.88 bars)

Software version	2		
Lubricant name	Mobil EAL Arctic 68		
Viscosity	0		
Oil refractive index	1.438		
Spacer type	Silica		
Ball diameter	0.01905		
Disc track radius	0.04312		
Trigger point	488		
Comments	Mobil EAL 68 under R-134a pressure 2/25/98		
Temperature=Ambi	45 65°C Load=20N		
M.R.=0.145 Trig. Pt.=488			
Avg. Band Top=227 Bottom=290			
Spacer Layer Film Thickness=485.1			
R.I.25°C=1.4516 45°C=1.4445 65°C=1.4384			
Disc #368			
Number of logged c	140		
Disc Speed (m/s)	Pot Temp (°C)	Lube Temp (°C)	Film (nm)
1.08E-02	24.55439	23.37471	8.380868
1.08E-02	24.55898	23.36964	8.103821
1.09E-02	24.55898	23.36964	7.792149
1.40E-02	24.56816	23.42041	9.766029
1.41E-02	24.57275	23.41026	9.766029
2.02E-02	24.56816	23.42041	13.5058
2.03E-02	24.56816	23.40518	13.5058
2.82E-02	24.57275	23.46611	16.31053
0.0282102	24.56357	23.43057	16.2759
0.0282102	24.56816	23.41026	16.2759
3.93E-02	24.56357	23.46103	20.98483
3.93E-02	24.55439	23.47119	20.84633
3.93E-02	24.57275	23.45088	20.98483
3.93E-02	24.57275	23.45595	20.77708
5.50E-02	24.5498	23.45088	25.86654
5.51E-02	24.56816	23.49657	25.90117
5.52E-02	24.5498	23.46103	25.55496
7.72E-02	24.53602	23.50165	33.34422
7.73E-02	24.54061	23.48642	33.65579
7.73E-02	24.57275	23.48134	33.34422
0.1073401	24.54061	23.51181	41.82486
0.1074072	24.56816	23.50673	41.65179
0.1075308	24.55439	23.49657	42.17098
0.1498476	24.5498	23.55243	53.17684
0.150069	24.55439	23.53719	53.38452
0.2099066	24.56816	23.54735	66.46456
0.2099632	24.50388	23.55243	66.67217
0.2101093	24.5452	23.56766	66.56835
0.2949609	24.53602	23.58289	84.59252
0.2953766	24.55439	23.50165	84.43109
0.295393	24.55439	23.56258	84.62712
0.4126308	24.40746	23.1056	118.8829
0.4126968	24.40286	23.10053	118.5371

EHD Data for Mobil EAL Arctic 68 Under R-134a Pressure (~15 wt%)
(T=23.0 ± 0.5°C, P=3.22 bars; T=45°C, P=5.15 bars; T=65°C, P=6.88 bars)

0.5768371	24.42582	23.12592	148.4031
0.5772505	24.40286	23.11576	148.6104
0.8077223	24.4396	23.20716	193.6087
0.8079046	24.40746	23.16146	193.7981
0.8089695	24.45337	23.19192	194.0823
1.13224	24.4396	23.20716	239.5365
1.132603	24.43041	23.23762	238.8264
1.583419	24.45337	23.30871	290.0779
1.584332	24.44878	23.26301	290.0779
1.58503	24.45337	23.31886	289.6994
2.217332	24.47633	23.48134	363.5055
2.217431	24.41205	23.48642	363.3252
2.218488	24.46715	23.48642	363.3252
3.105011	24.47174	23.56258	441.0063
3.105065	24.51765	23.65398	440.1654
3.105527	24.50388	23.62351	440.6459
slope=0.715			
1.08E-02	42.962	45.20297	3.588412
1.08E-02	42.95282	45.19281	3.588412
1.40E-02	42.85181	45.00494	4.419517
1.40E-02	42.91609	44.99987	4.419517
1.40E-02	42.94823	45.07603	4.350258
1.41E-02	42.92527	45.06079	4.523409
2.03E-02	42.79211	44.91355	6.289609
2.03E-02	42.81966	44.98971	6.705156
2.82E-02	42.75538	44.91862	8.367344
2.82E-02	42.75079	44.98463	8.367344
3.92E-02	42.84262	45.17758	10.86065
3.93E-02	42.82885	45.15219	10.86065
3.93E-02	42.84262	45.16235	10.86065
0.0550999	42.87476	45.25882	14.25414
5.51E-02	42.90231	45.24359	13.97716
7.71E-02	42.92986	45.30959	18.96317
7.72E-02	42.91609	45.30959	18.33997
7.72E-02	42.9115	45.30959	18.44382
0.107173	42.92527	45.31467	23.32576
0.1071818	42.94364	45.27405	23.53349
0.1498368	42.90231	45.29944	29.2574
0.1499048	42.90231	45.25882	29.48821
0.2098236	42.98037	45.32483	37.24238
0.2098315	42.94823	45.29436	36.89622
0.2098315	42.98037	45.32991	36.89622
0.2949761	42.96659	45.31467	47.90295
0.2950124	42.98955	45.30452	47.41843
0.2950124	42.96659	45.31467	47.93756
0.4117686	42.70488	45.08619	59.61335
0.4122894	42.70488	45.10649	59.61335
0.5769667	42.7462	45.02525	75.45995
0.5771549	42.72783	45.00494	75.39076

EHD Data for Mobil EAL Arctic 68 Under R-134a Pressure (~15 wt%)
(T=23.0 ± 0.5°C, P=3.22 bars; T=45°C, P=5.15 bars; T=65°C, P=6.88 bars)

0.8076492	42.75538	45.05064	93.65471
0.8078539	42.76916	45.05572	93.6547
1.132227	42.94823	45.28928	122.9996
1.132846	42.95282	45.30959	122.7921
1.586787	42.96659	45.36037	152.2417
1.587058	42.99874	45.32483	152.3799
1.588807	42.98496	45.35529	152.5527
2.221289	43.07679	45.29944	201.2623
2.222028	43.05843	45.32991	201.1202
2.22306	43.09975	45.37053	201.1202
3.109476	43.11812	45.29436	246.9022
3.109717	43.1273	45.36037	246.8549
3.110037	43.14108	45.33498	246.9969
slope=0.737			
1.08E-02	59.1473	64.80727	2.415575
1.09E-02	59.17485	64.80219	2.520464
1.40E-02	59.60186	65.38611	3.045029
1.41E-02	59.63401	65.35056	3.045029
2.02E-02	60.01511	65.50288	4.094091
2.02E-02	60.17122	65.48257	3.884274
2.03E-02	60.10694	65.56382	3.884297
0.0282049	59.61564	65.15762	5.003294
2.82E-02	59.60646	65.24393	5.143156
2.82E-02	59.67074	65.34548	5.352932
3.93E-02	59.76257	65.51812	7.346079
3.93E-02	59.77175	65.56889	7.24118
3.93E-02	59.76716	65.58413	7.346079
0.055119	59.84981	65.75677	9.409135
5.51E-02	59.87277	65.7466	9.548979
0.0551502	59.85899	65.67552	9.339201
7.72E-02	59.94623	65.75677	11.85673
7.73E-02	59.95541	65.6806	11.85673
0.1073137	60.01051	65.75169	15.14334
0.1073475	60.01511	65.7466	15.21328
0.1498476	60.06561	65.70599	19.40878
0.1499496	59.98756	65.70091	19.26891
0.1499895	60.08857	65.59428	19.19903
0.2098968	60.09776	65.57905	24.23323
0.2099114	60.08857	65.58413	24.79258
0.2953432	60.12989	65.3201	31.57421
0.2953523	60.07021	65.29471	31.67907
0.2954234	60.11153	65.24393	31.78392
0.412688	59.70747	65.30486	39.77196
0.4128982	59.66615	65.25916	39.70206
0.5772843	59.73502	65.30994	51.16497
0.5778906	59.67074	65.33025	51.65421
0.8087277	59.80848	65.45719	65.42112
0.8087386	59.77634	65.45211	65.28135
1.133979	60.05184	65.76184	81.87543

EHD Data for Mobil EAL Arctic 68 Under R-134a Pressure (~15 wt%)
 (T=23.0 ± 0.5°C, P=3.22 bars; T=45°C, P=5.15 bars; T=65°C, P=6.88 bars)

1.134586	59.87736	65.60951	81.83984
1.134922	59.84522	65.52827	81.83981
1.13495	60.07479	65.76184	81.87543
1.587373	60.07021	65.73645	103.0394
1.589067	60.04725	65.72122	103.1442
2.22247	60.15285	65.49273	130.0615
2.224123	60.10234	65.5892	129.8521
2.224544	60.19418	65.48766	129.6426
3.108995	60.23091	65.39626	165.4477
3.112805	60.32274	65.39626	165.4477
3.114797	60.26305	65.39626	165.4477
slope=0.739			

EHD Data for Mobil EAL Arctic 68 Under R-134a Pressure (~30 wt%)
(T=22.6 ± 0.2°C, P=4.95 bars; T=45°C, P=8.19 bars; T=65°C, P=11.57 bars)

Software version	2		
Lubricant name	Mobil EAL Arctic 68		
Viscosity	0		
Oil refractive index	1.452		
Spacer type	Silica		
Ball diameter	0.01905		
Disc track radius	0.04363		
Trigger point	170		
Comments	Mobil EAL 68 under R-134a pressure 2/26/98		
Temperature=Ambie	45	65°C	
M.R.=0.143 Trig. Pt.=170			
Avg. Band Top=237 Bottom=298			
Spacer Layer Film Thickness=486.1			
R.I.25°C=1.4516 45°C=1.4884 65°C=1.4387			
Disc #368			
Number of logged d	126		
Disc Speed (m/s)	Pot Temp (°C)	Lube Temp (°C)	Film (nm)
9.48E-03	24.08146	22.66894	3.532432
9.48E-03	24.08605	22.61816	3.428566
1.43E-02	24.07686	22.66386	4.571396
1.43E-02	24.04472	22.67402	4.571396
1.43E-02	24.08605	22.66386	4.43287
2.06E-02	24.08605	22.66386	5.194749
0.0206297	24.08605	22.65878	5.40255
2.86E-02	24.06309	22.68925	6.856979
2.86E-02	24.04013	22.6994	6.787715
3.99E-02	24.04931	22.68417	8.011272
0.0399389	24.04013	22.69433	8.103662
0.0542881	24.04472	22.72987	10.35448
5.43E-02	24.05391	22.71971	10.52764
5.43E-02	24.00799	22.70956	10.43529
5.43E-02	24.04013	22.72479	10.493
7.66E-02	24.03095	22.75018	13.09007
7.67E-02	24.04472	22.72479	13.15932
0.107025	24.02176	22.75526	17.03741
0.1070424	24.02636	22.72479	16.89892
0.1070424	24.04013	22.71971	16.89892
0.1500405	24.01258	22.72479	20.98451
0.1502696	24.02636	22.74002	20.84603
0.2109558	24.01258	22.76541	25.76229
0.2111275	24.02636	22.76541	25.76233
0.2940577	24.01258	22.77557	33.23989
0.2941715	24.00799	22.76033	33.17064
0.2944249	24.02176	22.77049	33.34371
0.4126363	23.93912	22.44045	43.41642
0.4128218	23.93452	22.47599	43.20872
0.5778947	23.93912	22.47091	54.5257
0.5779942	23.92075	22.46076	54.6295
0.8078369	23.92534	22.49122	67.91675
0.8084213	23.92534	22.46076	67.70917
1.132985	23.96207	22.60293	82.32504
1.133491	23.93452	22.52677	82.23915
1.134442	23.94371	22.51154	82.44667
1.585496	23.96207	22.63847	101.6244

EHD Data for Mobil EAL Arctic 68 Under R-134a Pressure (~30 wt%)
(T=22.6 ± 0.2°C, P=4.95 bars; T=45°C, P=8.19 bars; T=65°C, P=11.57 bars)

1.58645	23.98044	22.65878	101.6244
2.221058	23.98503	22.6994	126.2424
2.221058	23.97585	22.68925	126.2424
2.221601	23.98503	22.66894	126.3115
3.105339	23.97126	22.76033	153.6859
3.106173	23.98503	22.78064	153.7551
3.106284	23.97585	22.75526	153.6859
slope=0.669			
9.39E-03	42.64059	45.43653	2.077955
1.43E-02	42.64518	45.34514	2.839849
1.43E-02	42.66814	45.29944	2.839849
2.05E-02	42.58549	45.20805	3.463204
2.86E-02	42.50285	45.20297	4.363563
2.86E-02	42.51203	45.23851	4.363563
3.99E-02	42.47989	45.26897	5.610308
3.99E-02	42.4707	45.27405	5.610308
5.42E-02	42.48448	45.39591	6.441387
5.43E-02	42.57172	45.40607	6.718455
5.43E-02	42.51203	45.38068	6.441387
7.66E-02	42.62682	45.22328	8.726922
0.0766281	42.61763	45.23343	8.726922
0.1070844	42.67273	45.31467	11.0124
0.1071127	42.70488	45.28421	11.01243
0.1501558	42.71406	45.25374	14.33661
0.1502968	42.70947	45.18266	14.12888
0.2111081	42.7462	45.11157	17.86836
0.2111409	42.66814	45.03033	17.66064
0.2942163	42.76456	45.14711	22.23088
0.2944456	42.75538	45.11665	22.23088
0.4129469	42.81507	45.45177	28.04722
0.4130614	42.81507	45.45177	27.94335
0.5779899	42.79211	45.36037	35.62838
0.578188	42.79211	45.31975	35.80146
0.5784231	42.79671	45.3756	35.73222
0.8087567	42.77375	45.4213	45.49303
0.8091159	42.76456	45.44669	45.42381
1.134355	42.81507	45.47715	57.62226
1.135148	42.84262	45.44161	57.55304
1.135268	42.81507	45.49239	57.62226
1.135628	42.79671	45.46192	57.43251
1.135677	42.68651	45.47208	57.3287
1.588929	42.83344	45.43145	71.11654
1.589361	42.79211	45.44161	71.11654
2.225565	42.92527	45.25374	88.65498
2.225792	42.90231	45.27913	88.75876
3.111726	42.95282	45.18773	110.6151
3.11349	42.94364	45.16742	110.5459
slope=0.692			
9.44E-03	59.64319	67.1023	1.315997
9.52E-03	59.59727	67.02615	1.315997

EHD Data for Mobil EAL Arctic 68 Under R-134a Pressure (~30 wt%)
(T=22.6 ± 0.2°C, P=4.95 bars; T=45°C, P=8.19 bars; T=65°C, P=11.57 bars)

1.43E-02	58.98659	66.56409	1.939388
1.43E-02	58.85344	66.493	1.939388
2.07E-02	58.656	65.73138	2.285751
2.07E-02	58.7111	65.71107	2.285751
2.87E-02	57.99481	64.58894	2.701319
2.88E-02	57.95349	64.48231	3.013022
2.88E-02	58.3805	65.04591	2.701319
0.0398803	57.82034	65.10684	3.636364
4.00E-02	57.8387	65.17285	3.740232
5.44E-02	58.34837	65.87862	4.25969
5.44E-02	58.37592	65.94463	4.155818
7.68E-02	58.46315	65.86339	5.818083
0.0768519	58.59631	65.7923	5.818083
0.1071145	59.79471	66.96521	7.480302
0.1073393	59.43657	67.22417	7.480302
0.1504354	59.81308	66.0868	9.83506
0.1505143	59.79012	66.06142	9.558037
0.1505143	59.78553	66.03095	9.869678
0.1505847	59.84522	66.08173	9.66193
0.2112796	59.56513	65.75169	13.0901
0.2113225	59.5284	65.772	12.88236
0.2944829	59.67074	65.97002	16.72574
0.2947905	59.62482	65.93955	16.4141
0.4135886	58.50448	65.50288	21.67699
0.4136547	58.50907	65.53336	21.71161
0.4136747	58.47234	65.49781	21.74622
0.5787714	58.55958	65.51305	27.42402
0.5791581	58.53203	65.44704	27.49327
0.810022	58.54121	65.62475	35.31678
0.8107625	58.54121	65.55874	35.31678
0.9190375	58.52744	65.59428	35.38604
1.136885	58.74324	65.75677	44.24703
1.137224	58.70651	65.76692	44.45469
1.592194	58.82589	65.68568	55.25242
1.592257	58.88558	65.72122	55.04481
1.592276	58.79375	65.73645	55.04481
2.229279	59.17485	65.58413	69.16231
2.229759	59.09679	65.62982	69.3699
3.116226	59.39065	65.25916	84.93723
3.11747	59.34015	65.26933	84.83347
3.118627	59.32637	65.2744	84.7297
slope=0.731			

EHD Data for Mobil EAL Arctic 68 Under R-134a Pressure (~50 wt%)
(T=23.0 ± 0.5°C, P=6.19 bars; T=45°C, P=10.61 bars; T=65°C, P=15.85 bars)

Software version	2		
Lubricant name	Mobil EAL Arctic 68		
Viscosity	0		
Oil refractive index	1.439		
Spacer type	Silica		
Ball diameter	0.01905		
Disc track radius	0.04194		
Trigger point	458		
Comments	Mobil Arctic 68 under R-134a pressure 3/23/98		
Temperature=Ambie	45	65°C Load=20N	
M.R.=0.145 Trig. Pt.=458			
Avg. Band Top=234 Bottom=290			
Spacer Layer Film Thickness=493.0			
R.I.25°C=1.4516 45°C=1.4448 65°C=1.4387			
Disc #374			
Number of logged da	100		
Disc Speed (m/s)	Pot Temp (°C)	Lube Temp (°C)	Film (nm)
2.75E-02	24.55898	23.13099	1.973863
0.0275495	24.53143	23.07514	1.869981
3.98E-02	24.55898	23.12084	2.493323
3.98E-02	24.55439	23.14115	2.424041
5.53E-02	24.53143	23.14115	2.908831
0.0553052	24.5452	23.13099	2.908831
7.68E-02	24.53143	23.08529	3.601393
0.1074883	24.54061	23.09037	4.674889
0.1075895	24.53602	23.10053	4.709509
0.1507253	24.51306	23.15638	6.094559
0.150757	24.55439	23.12084	6.02531
0.1507647	24.52225	23.14622	6.510088
0.1510367	24.52225	23.14115	6.510088
0.2107015	24.54061	23.12084	7.99903
0.2109825	24.50388	23.12592	7.99903
0.2955315	24.45796	23.12592	9.45327
0.2956198	24.46255	23.12592	9.557145
0.2957298	24.45796	23.1056	9.45327
0.4142211	24.41664	23.04975	12.11935
0.4142973	24.43501	23.0396	12.60411
0.4145059	24.41205	23.02944	12.46562
0.5793837	24.41205	23.05991	15.37392
0.5794659	24.4396	23.07006	14.8546
0.8108302	24.44419	23.09037	19.94388
0.8113499	24.46255	23.06499	20.35933
1.132829	24.36613	23.07514	25.8982
1.133187	24.34317	23.06499	26.03667
1.133688	24.32022	22.93805	26.90208
1.134434	24.32481	22.91774	27.0059
1.587817	24.3294	22.96343	33.51351
1.590001	24.34777	22.98374	33.85964
2.222665	24.34317	23.00913	39.67429
slope=0.708			

EHD Data for Mobil EAL Arctic 68 Under R-134a Pressure (~50 wt%)
(T=23.0 ± 0.5°C, P=6.19 bars; T=45°C, P=10.61 bars; T=65°C, P=15.85 bars)

3.99E-02	44.89046	45.3756	1.662185
4.00E-02	44.78945	45.35022	1.662185
5.54E-02	44.95475	45.57363	2.077744
5.54E-02	44.94097	45.533	2.077744
7.68E-02	44.88128	45.60409	2.424037
7.69E-02	44.95934	45.61932	2.493323
0.1074782	44.89046	45.39083	3.220463
0.1075336	44.85832	45.30452	3.220463
0.107732	44.8721	45.45684	3.047327
0.150757	44.83077	45.37053	4.155472
0.150757	44.7068	45.38576	4.155472
0.1507948	44.84914	45.44161	4.155474
0.2107258	44.78945	45.43145	5.298172
0.2108499	44.817	45.43145	5.055764
0.2108514	44.71139	45.29944	5.194286
0.2110168	44.817	45.41114	5.402059
0.2955786	44.79404	45.36545	6.994861
0.2956192	44.78945	45.34514	6.64859
0.2960068	44.80782	45.34514	6.64859
0.4138488	44.35784	45.27913	8.726145
0.4142334	44.35784	45.22836	8.933905
0.4143026	44.35325	45.29944	8.933905
0.5793521	44.21091	44.83739	10.94213
0.579465	44.25683	44.8577	10.80362
0.8101196	44.22928	44.94401	14.47374
0.8107454	44.2155	44.89832	14.54299
1.134515	44.24764	45.05572	19.32069
1.134594	44.25224	45.05572	19.18223
1.590125	44.26601	45.29436	24.51349
1.590449	44.28897	45.24866	24.51349
1.590725	44.30733	45.28421	24.7212
2.225184	44.9777	45.82243	31.15982
2.227416	44.98689	45.84781	31.15981
2.228232	44.91801	45.70564	31.15982
slope=0.742			
7.67E-02	62.86647	64.98498	1.991698
7.68E-02	62.94453	65.12715	1.991698
7.68E-02	62.96749	65.06622	1.991698
0.1078665	62.05836	64.72095	2.515812
0.1079103	62.94912	65.83292	2.515848
0.1079484	62.51292	65.73138	2.585706
0.1079628	61.78745	65.04083	2.515824
0.1510064	58.96363	62.51223	3.144754
0.1510064	58.94986	62.53762	3.144754
0.2108343	58.83966	62.67471	3.983363
0.2114374	58.79375	62.64425	3.773713
0.2957307	64.33118	66.93983	5.450861
0.29607	59.76716	64.61432	4.821923
0.2961414	64.35414	66.93475	5.450861
0.41489	61.5992	64.56355	6.440798

EHD Data for Mobil EAL Arctic 68 Under R-134a Pressure (~50 wt%)
(T=23.0 ± 0.5°C, P=6.19 bars; T=45°C, P=10.61 bars; T=65°C, P=15.85 bars)

0.41489	61.59002	64.63971	6.440798
0.5805961	62.94453	65.9751	8.102876
0.5808685	62.50374	65.772	8.310608
0.812193	62.98586	65.90401	11.21913
0.8130331	63.00422	66.05126	11.32299
1.137158	62.99963	66.15789	14.95851
1.137455	62.82515	66.23913	14.95851
1.138485	62.98126	66.20358	14.95851
1.591786	64.33578	67.82331	20.54326
1.592267	64.45975	68.11781	20.96245
1.592515	64.322	67.91978	20.64806
1.592563	64.30823	67.8944	20.75286
1.592642	64.33118	68.0518	20.75287
1.593782	64.28986	67.8944	20.64806
2.23278	59.7993	63.44141	26.93554
2.232951	60.62579	64.24874	26.48152
2.233265	60.71762	64.35029	26.41165
2.233499	59.6891	63.39064	26.97048
2.233994	60.73139	64.462	26.41165
slope=0.779			

EHD Data for CPI Solest 68 Under R-134a Pressure (~10 wt%)
(T=23.0 ± 0.5°C, P=2.26 bars; T=45°C, P=3.63 bars; T=65°C, P=4.94 bars)

Software version	2		
Lubricant name	CPI Solest 68		
Viscosity	0		
Oil refractive index	1.44		
Spacer type	Silica		
Ball diameter	0.01905		
Disc track radius	0.04148		
Trigger point	119		
Comments	CPI Solest 68 under R-134a pressure 9/23/98		
Temperature=Ambient	45 65°C Load=20N		
M.R.=0.145 Trig. Pt.=119			
Avg. Band Top=234 Bottom=283			
Spacer Layer Film Thickness=502.0			
R.I.25°C=1.4531 45°C=1.4465 65°C=1.4396			
Disc #418			
Number of logged d	121		
Disc Speed (m/s)	Pot Temp (°C)	Lube Temp (°C)	Film (nm)
9.83E-03	23.98962	22.98882	12.37121
9.84E-03	23.98503	22.98374	12.16341
1.44E-02	24.02636	23.12592	17.14934
1.44E-02	23.98962	23.11068	16.94161
1.44E-02	23.99881	23.08022	16.59539
1.89E-02	24.00799	23.13099	20.6809
1.90E-02	24.01258	23.12084	20.36929
2.80E-02	24.04013	23.17669	27.05095
2.81E-02	24.03095	23.15638	27.43175
3.87E-02	23.99422	23.18685	34.25119
3.88E-02	23.99881	23.18177	34.38963
5.40E-02	24.02636	23.23254	43.31958
5.40E-02	24.01258	23.23254	43.38885
5.40E-02	24.00799	23.22746	43.38881
7.68E-02	24.02636	23.30363	56.60855
7.69E-02	24.02636	23.28332	56.88536
0.10736	24.01258	23.30871	72.52415
0.1073944	24.02176	23.30871	72.24736
0.1499621	24.01717	23.33409	89.47369
0.1499825	24.02176	23.28332	89.81955
0.2108102	24.01717	23.33917	116.7229
0.2108763	24.0034	23.32394	116.9995
0.294544	23.98962	23.49657	155.677
0.2945959	23.99881	23.50165	155.6296
0.4131218	23.7279	23.17669	193.555
0.4131242	24.00799	23.60828	192.4362
0.4133136	23.99881	23.59812	192.4362
0.5774969	23.71872	23.1513	241.9449
0.5776606	23.70035	23.12592	241.8029
0.8077006	23.79219	23.04467	311.1769
0.8080964	23.78759	23.04975	311.7781
1.132011	23.79678	23.05991	388.5948
1.132716	23.81055	23.05483	388.4145
1.586828	23.87483	23.20208	480.6161

EHD Data for CPI Solest 68 Under R-134a Pressure (~10 wt%)
(T=23.0 ± 0.5°C, P=2.26 bars; T=45°C, P=3.63 bars; T=65°C, P=4.94 bars)

1.587736	23.84269	23.17669	481.1991
2.222701	23.88402	23.29347	568.9039
2.223325	23.88402	23.21223	570.6516
3.102077	23.57638	23.38487	625.813
3.104888	23.61771	23.41533	627.5601
3.105478	23.54883	23.33917	625.813
3.108406	23.9483	23.6489	624.6907
slope=0.697			
9.80E-03	43.12634	44.84727	6.268001
9.81E-03	43.984	44.83712	6.268001
1.44E-02	42.92068	45.03033	7.255785
1.44E-02	43.08176	45.03595	7.206913
1.45E-02	44.37621	44.90847	7.415455
1.89E-02	45.4185	45.50762	9.606058
1.90E-02	45.28534	45.31467	9.606058
2.80E-02	43.90787	45.34006	12.28338
2.81E-02	43.90787	45.29944	12.42247
3.88E-02	43.30637	44.93386	15.86456
3.88E-02	43.41198	44.93893	16.07318
5.40E-02	43.20536	44.95925	21.32288
5.40E-02	43.19158	44.98463	21.28811
0.0768076	43.12271	45.05064	26.95455
7.68E-02	43.10893	44.99987	27.09359
0.1073115	43.03547	44.91862	34.8103
0.1073382	43.04465	44.97448	34.87983
0.1498691	43.00792	44.95417	44.88933
0.1500021	43.02169	44.9237	44.47231
0.2105635	42.98496	45.01002	59.24072
0.2107249	42.95282	45.02018	59.13651
0.2944327	42.95741	44.97956	72.75539
0.2945498	42.94823	44.97956	73.17224
0.4130561	42.93904	44.98971	91.58118
0.4130675	44.04562	45.92397	88.52491
0.4131075	42.92068	44.99479	91.23389
0.5773968	43.82063	45.29436	116.4431
0.5774661	43.87572	45.39591	115.7487
0.577557	43.80226	45.28928	116.4431
0.5780643	43.90787	45.467	115.8182
0.8073532	43.64156	45.31467	156.9707
0.807534	43.6737	45.30452	157.0658
1.131847	43.51758	45.25374	195.1661
1.132209	43.58187	45.25374	195.1661
1.586631	43.49922	45.25882	240.6666
1.587429	43.50381	45.28928	240.3813
2.220611	43.46708	45.28421	303.307
2.220679	43.46708	45.36037	303.307
3.105963	43.44412	45.467	359.8091
3.107581	43.43953	45.36545	360.6541

EHD Data for CPI Solest 68 Under R-134a Pressure (~10 wt%)
(T=23.0 ± 0.5°C, P=2.26 bars; T=45°C, P=3.63 bars; T=65°C, P=4.94 bars)

slope=0.729			
9.84E-03	58.55039	65.58413	3.827415
9.89E-03	58.44938	65.5232	3.827415
1.44E-02	62.13182	65.80754	4.735969
1.45E-02	61.86551	65.45719	4.631135
1.90E-02	58.91313	64.34013	6.203478
1.90E-02	58.94527	64.39599	6.203478
2.81E-02	61.04821	65.54858	7.671017
0.0280789	61.03902	65.53843	7.46138
3.86E-02	61.00689	65.51305	10.18675
3.87E-02	61.03902	65.51305	9.767467
3.88E-02	61.03902	65.48766	9.662646
0.053977	60.8875	65.56889	13.19148
5.41E-02	60.8875	65.57905	13.1216
7.67E-02	60.70384	65.40134	17.10449
7.68E-02	60.73139	65.48766	16.68524
0.0768366	60.73598	65.47242	17.10449
0.107201	60.57987	65.38103	21.71581
0.1072888	60.61201	65.42165	22.48438
0.1498982	60.42835	65.15254	27.7242
0.149934	60.33652	65.117	27.79405
0.2105277	60.0197	64.59909	36.03719
0.2105839	60.16204	64.64479	35.64136
0.2945127	59.86358	64.23351	45.46664
0.2946025	59.77175	64.24874	45.81585
0.4129814	59.72584	64.38075	58.73555
0.4133146	59.69829	64.34521	58.31656
0.5772702	59.79471	64.91389	72.35093
0.5775153	59.8544	65.0256	72.00185
0.8074041	59.7442	64.71587	91.19869
0.8074853	59.76257	64.81235	91.05907
1.131909	59.77634	64.70064	116.8794
1.131976	59.78093	64.8885	117.1585
1.585879	60.49722	64.90882	153.7269
1.586084	60.57069	65.04591	153.6313
1.586945	60.87832	65.4775	150.7628
2.222489	60.42376	64.6194	188.9076
2.223912	60.41457	64.70572	188.6208
3.106138	60.46508	64.55847	226.3686
3.106238	60.47426	64.58385	226.4323
3.108165	60.42835	64.55847	226.4642
slope=0.724			

EHD Data for CPI Solest 68 Under R-134a Pressure (~15 wt%)
(T=23.0 ± 0.5°C, P=3.22 bars; T=45°C, P=5.15 bars; T=65°C, P=6.67 bars)

Software version	2		
Lubricant name	CPI Solest 68		
Viscosity	0		
Oil refractive index	1.44		
Spacer type	Silica		
Ball diameter	0.01905		
Disc track radius	0.04115		
Trigger point	294		
Comments	CPI Solest 68 under R-134a pressure 3/19/98		
Temperature=Ambi	45	65°C Load=20N	
M.R.=0.148 Trig. Pt=300			
Avg. Band Top=230 Bottom=290			
Spacer Layer Film Thickness=504.3			
R.I.25°C=1.4531 45°C=1.4465 65°C=1.4396			
Disc #374			
Number of logged d	145		
Disc Speed (m/s)	Pot Temp (°C)	Lube Temp (°C)	Film (nm)
0.0103204	24.35695	23.13099	7.7872
1.04E-02	24.35236	23.11576	7.7872
0.0148811	24.34317	23.14115	10.90083
1.49E-02	24.34317	23.14115	10.90083
1.94E-02	24.37531	23.197	13.5991
1.94E-02	24.36613	23.197	13.5991
2.84E-02	24.37991	23.25285	17.54267
2.85E-02	24.37072	23.23254	17.54267
3.90E-02	24.36154	23.24778	21.90105
3.90E-02	24.35695	23.23762	22.31613
3.91E-02	24.33858	23.28839	22.52358
5.41E-02	24.37531	23.30363	28.74933
5.42E-02	24.34777	23.29347	28.74936
5.42E-02	24.34777	23.30363	28.54181
7.68E-02	24.36613	23.31886	37.3952
7.68E-02	24.35695	23.30871	37.25687
0.1070204	24.35236	23.27316	48.04535
0.1070873	24.35236	23.31886	48.25283
0.1507605	24.35236	23.32394	60.28408
0.1509799	24.34317	23.33917	60.49154
0.2109149	24.33399	23.38487	75.00909
0.210981	24.32481	23.37979	75.42381
0.2109845	24.3294	23.33409	75.21645
0.2954089	24.31562	23.38487	97.54001
0.2954133	24.32481	23.42549	97.33266
0.2954826	24.33399	23.41533	97.40176
0.2955583	24.34777	23.42549	97.60914
0.4130967	24.32481	23.45088	133.457
0.4133878	24.14115	22.75526	130.7554
0.4134045	24.32022	23.4915	133.457
0.4139003	24.14115	22.76541	130.6517
0.578079	24.3294	23.06499	173.4389
0.5782722	24.36154	23.08022	173.3443
0.5786311	24.34777	23.07006	173.3443
0.8089955	24.12737	22.82126	219.5685

EHD Data for CPI Solest 68 Under R-134a Pressure (~15 wt%)
(T=23.0 ± 0.5°C, P=3.22 bars; T=45°C, P=5.15 bars; T=65°C, P=6.67 bars)

0.8092829	24.12737	22.82634	221.1768
1.131872	24.14115	22.82634	269.8391
1.131956	24.1641	22.83142	269.6973
1.586415	24.1687	22.84665	336.1574
1.587041	24.15951	22.92789	335.9772
2.220952	24.18247	23.0396	411.9892
2.22102	24.2192	23.17669	411.0288
3.110092	24.26512	23.52196	491.1978
3.112297	24.30185	23.54227	490.8338
3.11273	24.26971	23.53212	491.1978
slope=0.731			
0.0103488	43.15485	45.65487	4.641999
0.0103488	43.12271	45.65487	4.294603
1.04E-02	43.14567	45.49239	4.641999
1.04E-02	43.11353	45.6701	4.294603
1.49E-02	42.57631	44.84754	5.892652
1.49E-02	42.92527	45.10142	5.684218
1.49E-02	42.6911	44.88308	5.684218
1.94E-02	42.51203	44.77138	6.934866
0.0194519	42.49825	44.77138	7.351757
1.95E-02	42.50285	44.75107	7.351757
2.84E-02	42.5304	44.93386	9.158216
2.85E-02	42.57172	44.9694	9.019268
3.90E-02	42.61763	45.03541	11.52048
3.90E-02	42.636	45.05064	11.52048
5.41E-02	42.69569	45.13188	14.36889
0.054131	42.70488	45.14204	14.64675
5.41E-02	42.68651	45.11665	14.43834
5.42E-02	42.70488	45.10142	14.6468
7.67E-02	42.74161	45.26897	19.09289
7.68E-02	42.72324	45.24359	19.12761
7.68E-02	42.7462	45.29944	19.23186
0.1069424	42.79671	45.3756	25.13635
0.107059	42.81966	45.40099	25.48371
0.1505472	42.90691	45.533	31.94321
0.1505985	42.88395	45.5127	32.7768
0.1506485	42.8564	45.50254	32.36
0.1506979	42.87476	45.51777	31.94321
0.2106769	42.95282	45.52285	42.43016
0.2108734	42.95741	45.50762	42.56905
0.2952145	43.0171	45.48223	52.98486
0.295384	43.00333	45.48223	52.98485
0.4132844	42.8013	45.34006	64.28288
0.4133235	42.80589	45.34514	64.28288
0.4134501	42.7462	45.29944	64.49116
0.5780168	42.75998	45.25374	84.20413
0.578171	42.76456	45.25374	82.73136
0.5783418	42.77834	45.27405	84.68998
0.8093336	42.85181	45.28928	110.7649
0.8097774	42.85181	45.27913	110.4874

EHD Data for CPI Solest 68 Under R-134a Pressure (~15 wt%)
(T=23.0 ± 0.5°C, P=3.22 bars; T=45°C, P=5.15 bars; T=65°C, P=6.67 bars)

1.133052	42.90691	45.32483	138.9959
1.133276	42.92527	45.34006	139.5506
1.588489	43.02169	45.5127	183.6879
1.588892	43.02629	45.52793	183.5929
2.22299	43.08598	45.53808	222.8829
2.223857	43.06302	45.533	222.8354
3.111896	43.18699	45.60917	268.6133
3.113174	43.15944	45.5787	268.3284
3.115452	43.17781	45.59394	268.4708
slope=0.748			
1.04E-02	58.57335	64.80219	3.009087
0.0104272	59.44116	65.12207	3.051376
0.014896	58.6009	64.58894	3.5189621
0.014896	59.07383	64.87835	3.542216
0.014896	59.22535	64.93929	4.189617
1.49E-02	59.34933	65.05607	4.189617
1.94E-02	59.04169	65.00529	4.608554
1.94E-02	59.08302	65.02052	4.608554
2.84E-02	59.83144	65.88878	5.865362
2.84E-02	59.84063	65.87862	5.865362
2.84E-02	59.54218	65.41149	6.284278
2.85E-02	59.78093	65.84816	6.074818
3.90E-02	59.78093	65.77708	7.541081
3.91E-02	59.6937	65.73138	7.331629
3.91E-02	59.77634	65.75169	7.541081
5.41E-02	60.25387	66.33052	9.798596
5.41E-02	60.30437	66.37622	10.05458
5.42E-02	60.31815	66.3813	9.740397
5.42E-02	60.30897	66.36607	9.91496
0.0542192	60.29978	66.35591	9.705487
7.67E-02	60.51559	67.1023	12.2048
7.68E-02	60.47426	66.97029	12.06515
0.1069982	59.84063	66.11219	16.28869
0.1070585	59.84522	66.10711	15.97456
0.1507	59.78553	65.30486	21.00064
0.1508677	59.77634	65.2744	21.21004
0.2110671	59.57431	65.08145	27.63167
0.2113109	59.57891	65.06622	27.70144
0.2958668	59.6891	65.01037	34.61102
0.2959193	59.70288	65.01545	34.61102
0.2959332	59.73502	65.05607	34.61102
0.4136437	59.82685	65.46735	45.49736
0.4136989	59.82226	65.38103	45.56715
0.5782432	59.81308	65.75169	57.49835
0.5784259	59.98296	65.88371	57.38207
0.5785051	59.79471	65.74153	57.42859
0.809135	60.02888	65.88878	72.52951
0.8098991	59.97837	66.01572	72.70573
0.8101922	59.97837	65.99541	72.91498
1.133412	60.0197	65.85831	93.55643

EHD Data for CPI Solest 68 Under R-134a Pressure (~15 wt%)
(T=23.0 ± 0.5°C, P=3.22 bars; T=45°C, P=5.15 bars; T=65°C, P=6.67 bars)

1.133673	60.01051	65.82785	93.45184
1.588267	60.13449	65.95986	122.1817
1.589628	60.1253	65.61967	117.4004
1.590086	60.03347	65.7263	117.8187
1.590669	60.16204	65.99541	122.1817
1.590816	60.05184	65.74153	117.8187
2.22463	60.37325	66.11219	154.1408
2.225893	60.32274	66.10204	154.2841
2.226344	60.36866	66.14265	153.9975
3.114841	60.49263	66.16805	186.6633
3.115124	60.54314	66.22389	186.6633
3.115252	60.49263	66.16296	186.6633
slope=0.741			

EHD Data for CPI Solest 68 Under R-134a Pressure (~30 wt%)
(T=22.2 ± 0.5°C, P=5.70 bars; T=45°C, P=9.15 bars; T=65°C, P=12.19 bars)

Software version	2		
Lubricant name	CPI Solest 68		
Viscosity	0		
Oil refractive index	1.44		
Spacer type	Silica		
Ball diameter	0.01905		
Disc track radius	0.04445		
Trigger point	291		
Comments	CPI Solest 68 under R-134a pressure 10/12/98		
Temperature=Ambi	45 65°C Load=20N		
M.R.=0.145 Trig. Pt.=291			
Avg. Band Top=234 Bottom=287			
Spacer Layer Film Thickness=480.1			
R.I.25°C=1.4531 45°C=1.4465 65°C=1.4396			
Disc #418			
Number of logged c	141		
Disc Speed (m/s)	Pot Temp (°C)	Lube Temp (°C)	Film (nm)
1.10E-02	23.68658	22.46076	3.533462
1.10E-02	23.66821	22.43537	3.533462
1.43E-02	23.63607	22.53692	4.572691
1.44E-02	23.64985	22.56739	4.260918
2.08E-02	23.51669	22.05456	5.47333
2.09E-02	23.51669	22.03933	5.611902
2.73E-02	23.50292	22.0444	6.651108
2.74E-02	23.52128	22.03933	6.581768
3.87E-02	23.50292	22.04948	8.521585
3.88E-02	23.52588	22.0444	8.521585
5.51E-02	23.48914	22.06471	11.15409
0.0551623	23.49373	22.05456	11.22337
7.62E-02	23.47078	22.05964	14.02894
7.63E-02	23.48914	22.03425	14.13285
0.1073375	23.47996	22.0444	17.8734
0.1074507	23.47537	22.0444	17.80413
0.1514171	23.47537	22.05964	23.03371
0.1514647	23.47996	22.06471	23.12606
0.2115011	23.47078	22.06979	29.30175
0.2116409	23.47537	22.02917	29.30175
0.2116556	23.47996	22.07487	28.81695
0.2947241	23.46159	22.06979	36.15783
0.294987	23.47537	22.04948	36.15787
0.4125454	23.42027	21.88192	44.53655
0.4123207	23.42945	21.85653	44.53656
0.5770419	23.44323	22.0901	56.99885
0.5771296	23.42027	21.90731	56.5835
0.5771793	23.46618	22.11041	56.86039
0.8107345	23.41568	21.94793	71.32767
0.8110117	23.42945	21.97332	71.12002
1.134429	23.43404	21.9987	90.49713
1.13455	23.43404	22.00886	90.98154
1.58935	23.53965	22.13072	114.1879
1.589409	23.5672	22.15611	114.5337

EHD Data for CPI Solest 68 Under R-134a Pressure (~30 wt%)
(T=22.2 ± 0.5°C, P=5.70 bars; T=45°C, P=9.15 bars; T=65°C, P=12.19 bars)

2.223489	23.56261	22.2932	143.8561
2.223546	23.55342	22.20181	143.8561
2.224423	23.56261	22.30336	143.6487
2.22477	23.54424	22.23227	144.2018
3.105515	23.62689	22.50138	188.1115
3.107138	23.65903	22.59278	187.3219
3.10851	23.64066	22.49122	187.6377
3.108586	23.64526	22.55723	187.6377
slope=0.698			
1.11E-02	43.52162	45.90393	2.295851
1.11E-02	43.01244	45.70511	2.295851
1.12E-02	41.20802	44.98944	2.087132
1.43E-02	41.95645	44.49719	2.643692
1.43E-02	43.32474	46.33525	2.921974
1.44E-02	41.89217	44.57843	2.643692
1.44E-02	43.31096	46.33525	2.921974
2.08E-02	43.06302	44.91862	3.617673
2.09E-02	42.99874	44.96432	3.617673
2.74E-02	43.14567	44.87801	4.174184
2.75E-02	43.15944	44.96432	4.278561
3.87E-02	43.35229	45.4213	5.217731
3.88E-02	43.31096	45.38576	5.635155
5.52E-02	43.37066	45.25374	6.678687
5.52E-02	43.36147	45.2639	6.678687
5.53E-02	43.30637	45.21312	6.678687
7.64E-02	43.08138	45.07603	8.661283
7.64E-02	43.08598	45.09634	8.765631
7.64E-02	43.05383	45.04556	8.556935
0.1073555	43.10893	45.24866	11.68721
0.107485	43.09975	45.19789	11.58291
0.1515207	43.32933	45.31467	14.60882
0.151532	43.33851	45.23343	14.60883
0.2117746	43.24668	45.07095	18.64308
0.2118263	43.26964	45.10142	18.43439
0.2119704	43.25586	45.09126	18.36485
0.2948749	43.20076	45.34006	23.85948
0.2949109	43.09975	45.33498	23.78996
0.4127324	43.62778	46.15246	28.86691
0.4128137	43.51758	46.12708	28.79735
0.4128807	43.50381	46.02045	29.07551
0.5777864	43.43953	45.83766	37.14227
0.5778732	43.40739	45.8275	37.14223
0.8109999	42.97578	44.77138	47.78044
0.8113839	43.18699	44.9694	47.84996
1.134576	43.40279	45.35529	59.45967
1.134673	43.43034	45.49239	59.32064
1.589807	43.46708	45.72595	73.8474
1.589968	43.44871	45.62948	74.54239
1.59012	43.49004	45.64471	74.14857

EHD Data for CPI Solest 68 Under R-134a Pressure (~30 wt%)
(T=22.2 ± 0.5°C, P=5.70 bars; T=45°C, P=9.15 bars; T=65°C, P=12.19 bars)

2.223124	43.50381	45.64471	91.35878
2.226191	43.47626	45.62948	91.56724
3.109625	42.95282	44.83739	112.0284
3.110213	43.44871	45.44161	112.4083
3.110626	43.47167	45.43653	112.8945
3.110674	43.04465	44.80692	112.8619
3.111034	43.45789	45.44669	112.7209
3.111063	43.0722	44.82215	112.9314
3.111854	42.97119	44.85262	112.8619
slope=0.698			
1.11E-02	60.26764	65.24901	1.468096
1.12E-02	60.33192	65.41149	1.468096
1.12E-02	60.42835	65.59936	1.677822
1.44E-02	59.58809	64.24366	1.887576
1.44E-02	59.86358	64.71587	1.817671
1.45E-02	59.57431	64.45184	1.887576
2.09E-02	59.04628	64.8273	2.481783
2.09E-02	57.88002	65.03576	2.586577
2.75E-02	59.8544	66.07157	3.14594
2.76E-02	59.54676	65.82785	2.831345
0.0389388	60.90587	64.85804	3.635254
3.90E-02	59.28964	64.70544	3.984795
3.90E-02	59.78553	64.70544	3.984795
3.90E-02	58.99578	64.66483	3.984795
0.0552474	58.47234	64.69021	4.613972
5.53E-02	58.69177	65.04564	4.928552
0.0553434	58.7285	65.01517	5.243117
7.65E-02	59.66155	65.73645	6.524695
7.65E-02	59.61105	65.89386	6.081982
7.66E-02	58.39428	64.64986	6.151868
0.107485	60.61201	65.63998	8.17909
0.1077246	60.6166	65.68568	8.598511
0.151801	60.26305	65.15762	11.115
0.1519276	60.26305	65.10176	10.6956
0.152338	60.19418	65.08145	11.32469
0.2119567	59.91409	64.86312	13.9459
0.212155	59.99674	64.90882	13.98084
0.2121994	59.86818	64.7768	14.26046
0.2952681	59.48248	64.59909	18.87347
0.2956269	59.54676	64.5737	18.66382
0.4130852	59.47789	65.42165	23.9056
0.4131105	59.49626	65.26424	23.9056
0.5784439	59.76257	65.18301	30.12531
0.5785504	59.5835	65.17793	29.84582
0.8121615	60.00592	65.61459	37.60226
0.8123897	60.33652	65.86339	37.60226
1.136406	60.50181	66.26959	47.24421
1.136471	60.65792	66.4473	47.22093
1.136556	58.77538	64.48231	46.89488

EHD Data for CPI Solest 68 Under R-134a Pressure (~30 wt%)
(T=22.2 ± 0.5°C, P=5.70 bars; T=45°C, P=9.15 bars; T=65°C, P=12.19 bars)

1.136832	58.94527	64.84789	46.75512
1.592071	60.75435	66.50824	58.49137
1.592109	58.55958	64.5582	59.05021
1.592151	58.58253	64.91362	58.6311
2.230347	60.26305	64.81235	77.20928
2.230856	60.15744	64.81742	77.0347
2.232381	60.24009	64.71587	76.92992
3.117124	60.38243	64.94944	94.1767
3.117286	60.35029	64.8885	94.73525
3.119063	60.35029	64.91898	94.24651
slope=0.734			

EHD Data for CPI Solest 68 Under R-134a Pressure (~50 wt%)
(T=23 ± 0.5°C, P=6.19 bars; T=45°C, P=10.67 bars; T=65°C, P=15.44 bars)

Software version	2		
Lubricant name	CPI Solest 68		
Viscosity	0		
Oil refractive index	1.44		
Spacer type	Silica		
Ball diameter	0.01905		
Disc track radius	0.04235		
Trigger point	24		
Comments	CPI Solest 68 undwer R-134a pressure 3/24/98		
Temperature=Ambie	45	65°C Load=20N	
M.R.=0.145 Trig. Pt.=24			
Avg. Band Top=237 Bottom=290			
Spacer Layer Film Thickness=492.0			
R.I.25°C=1.4531 45°C=1.445 65°C=1.4396			
Disc #374			
Number of logged da	122		
Disc Speed (m/s)	Pot Temp (°C)	Lube Temp (°C)	Film (nm)
1.38E-02	23.99881	22.47599	1.661138
1.38E-02	24.03095	22.48107	1.384242
2.00E-02	23.99422	22.46076	2.145585
2.00E-02	24.00799	22.46584	2.145585
2.77E-02	23.98044	22.44045	2.491637
2.78E-02	23.99422	22.46076	2.422403
2.78E-02	23.98962	22.46584	2.491637
3.86E-02	23.96667	22.45061	3.11452
3.87E-02	23.97126	22.45061	3.045308
3.87E-02	23.96207	22.46584	3.11452
0.0542051	23.9483	22.43537	3.806589
5.42E-02	23.97126	22.44553	4.152627
5.42E-02	23.97126	22.44553	4.221843
7.75E-02	23.93912	22.44045	5.190809
7.75E-02	23.93452	22.42522	5.260016
0.1070427	23.95289	22.44045	6.644142
0.1070693	23.93912	22.44553	6.851741
0.1504866	23.93912	22.44045	8.581879
0.1505165	23.93912	22.43537	8.720278
0.2109461	23.90697	22.44045	11.31539
0.211021	23.93452	22.45568	11.14237
0.2111606	23.91157	22.44045	11.14238
0.2949101	23.91157	22.42522	14.04879
0.2949778	23.91616	22.41506	14.32558
0.4131539	23.86106	22.27289	18.3736
0.4135532	23.87024	22.26274	18.68497
0.5778078	23.88402	22.27289	23.11325
0.5781518	23.87943	22.31351	23.04407
0.8096669	23.86565	22.32367	27.95633
0.8101476	23.88861	22.31351	28.0255
1.131233	23.88861	22.39983	34.56318
1.131536	23.88861	22.35921	34.45942
1.132014	24.0585	22.53692	34.35566
1.132298	24.07227	22.53692	34.45942

EHD Data for CPI Solest 68 Under R-134a Pressure (~50 wt%)
(T=23 ± 0.5°C, P=6.19 bars; T=45°C, P=10.67 bars; T=65°C, P=15.44 bars)

1.588243	24.06309	22.59785	41.58442
1.588481	24.07686	22.66386	41.72275
1.589003	24.07686	22.64355	41.93026
1.589555	24.06768	22.58262	41.72277
2.222402	24.01717	22.71971	50.02267
2.222662	24.06309	22.72479	50.02267
2.224468	24.09064	22.70448	50.02267
slope=0.698			
2.00E-02	45.31748	45.467	1.453405
2.00E-02	45.3634	45.4213	1.661076
2.77E-02	45.02362	45.23851	1.868747
2.78E-02	44.95475	44.95417	1.868747
3.87E-02	44.85832	45.11157	2.283934
0.0387294	45.62511	46.03568	2.387785
3.88E-02	44.86292	45.10142	2.283934
5.43E-02	44.40376	44.83739	3.114514
5.43E-02	44.491	44.87801	3.114514
7.76E-02	44.5415	45.05064	4.152627
7.76E-02	44.51395	45.04556	4.014211
7.77E-02	44.50477	45.05572	4.221843
7.77E-02	44.42672	45.11665	4.256454
0.1070207	44.57365	45.15219	5.294574
0.1071909	44.61038	45.19281	5.052384
0.1072133	44.58742	44.99987	5.190779
0.1507175	44.66088	45.23851	6.644119
0.1507323	44.63793	45.24359	6.644119
0.2112315	44.76649	45.43653	8.789482
0.211297	44.78027	45.42638	8.824077
0.2116447	44.75272	45.43145	8.824077
0.2951792	44.80782	45.65487	11.07319
0.2951914	44.80782	45.55331	10.81944
0.2954298	44.80322	45.55839	10.79637
0.4134331	44.75731	45.39083	13.91041
0.4137625	44.75731	45.37053	13.9796
0.5782139	44.78945	45.44669	17.12808
0.5785629	44.7619	45.3756	16.95509
0.8095984	44.72517	45.68025	21.38351
0.8098511	44.84914	45.62948	21.59108
0.8104894	44.79863	45.49239	21.59108
1.131875	44.85832	45.69549	26.36515
1.131901	44.85832	45.72087	26.46889
1.132531	44.86292	45.7158	26.43431
1.590569	45.72154	46.31495	32.69536
1.590722	45.73531	46.37587	32.66077
1.592142	45.73531	46.22863	32.59159
2.225218	45.75368	46.179223	39.85508
2.22571	45.77664	46.18518	39.37089
2.225865	45.75827	46.186332	39.54382
slope=0.690			

EHD Data for CPI Solest 68 Under R-134a Pressure (~50 wt%)
(T=23 ± 0.5°C, P=6.19 bars; T=45°C, P=10.67 bars; T=65°C, P=15.44 bars)

2.78E-02	61.95734	65.25409	1.466526
0.0278433	61.86092	65.36072	1.466526
2.79E-02	62.28793	65.53336	1.676134
2.79E-02	62.37058	65.72122	1.676134
3.88E-02	61.41094	64.462	1.990361
3.88E-02	61.34666	64.30967	1.990361
3.89E-02	61.44308	64.68541	2.025276
5.43E-02	61.62941	65.0149	2.61884
5.44E-02	61.73961	65.06568	2.61884
5.44E-02	61.76716	65.03014	2.514078
7.77E-02	61.64682	64.75087	3.368274
7.77E-02	61.63304	64.71533	3.391338
7.77E-02	61.59631	64.69502	3.391338
0.1070176	61.64222	64.88626	4.360269
0.1072687	61.55039	64.87103	4.360273
0.1073186	61.59172	64.81517	4.567901
0.1507252	61.2024	64.88583	5.744451
0.1508158	61.3805	64.6699	5.882844
0.1508675	61.21617	64.8706	6.021272
0.2113587	60.91868	64.70572	7.474554
0.2114061	60.6891	64.52801	7.474554
0.295117	60.81863	64.99513	9.204709
0.2952885	60.47426	65.00529	9.343073
0.2953471	60.40998	64.85297	9.481502
0.4132917	62.69658	64.8225	12.24961
0.413451	62.70577	64.95451	12.1112
0.5783283	62.62312	65.04083	14.94836
0.5783339	62.50374	65.06622	14.94835
0.5787542	62.67822	64.96467	15.15594
0.8104044	62.20528	65.25409	18.26977
0.8109182	62.47619	65.11192	18.06221
1.131054	61.96193	65.14746	22.83649
1.13331	61.9252	65.13731	22.83649
1.13337	61.82418	65.11192	23.04405
1.588753	61.67725	64.96467	28.44067
1.590138	61.56706	64.86819	28.50985
1.590914	61.60838	64.90374	28.44067
2.227925	61.38799	64.79711	34.66694
2.227925	61.3788	64.83773	34.66694
slope=0.717			

EHD Data for Idemitsu Kosan FVC33B Under R-134a Pressure (~10 wt%)
(T=22.5 ± 0.5°C, P=2.19 bars; T=45°C, P=3.57 bars; T=65°C, P=4.94 bars)

Software version	2		
Lubricant name	Idemitsu Kosan FVC32		
Viscosity	0		
Oil refractive index	1.426		
Spacer type	Silica		
Ball diameter	0.01905		
Disc track radius	0.0435		
Trigger point	59		
Comments	Idemitsu Kosan FVC32B under R-134a pressure		
5/14/98 Temperatur	45	65°C Load=20N	
M.R.=0.146 Trig. Pt.=59			
Avg. Band Top=237 Bottom=283			
Spacer Layer Film Thickness=496.1			
R.I.25°C=1.4394 45°C=1.4321 65°C=1.4256			
Disc #374			
Number of logged d	152		
Disc Speed (m/s)	Pot Temp (°C)	Lube Temp (°C)	Film (nm)
1.08E-02	23.68658	22.4963	7.966107
1.09E-02	23.69576	22.45061	7.966107
1.09E-02	23.69117	22.46584	7.89621
1.40E-02	23.70495	22.59785	9.223836
1.41E-02	23.70954	22.55723	9.223836
1.41E-02	23.71413	22.57754	9.328617
2.03E-02	23.70495	22.61308	12.15835
2.04E-02	23.70954	22.60801	11.73916
2.05E-02	23.70035	22.61816	12.15835
2.84E-02	23.70495	22.68417	15.79152
2.84E-02	23.70035	22.64863	15.93132
2.84E-02	23.68658	22.6334	15.93132
2.84E-02	23.69576	22.71464	16.56004
3.96E-02	23.71872	22.72479	20.84502
3.96E-02	23.70495	22.72987	20.89158
3.96E-02	23.69117	22.76033	22.00935
5.56E-02	23.69576	22.77557	27.24866
5.56E-02	23.69576	22.82634	28.36305
5.57E-02	23.70035	22.82126	28.36305
7.63E-02	23.47537	21.96824	37.58965
7.63E-02	23.46618	21.96316	38.07854
7.63E-02	23.47078	21.98347	37.38013
0.1066111	23.47078	21.98347	48.48446
0.1066164	23.46159	21.98347	48.55429
0.1496572	23.47537	21.98347	62.93828
0.1496641	23.48455	21.94285	63.42702
0.1497533	23.47078	21.98855	63.21756
0.2101665	23.46159	21.97332	78.78513
0.2102542	23.46159	21.96316	78.92471
0.2948331	23.45241	21.95809	99.93195
0.2948382	23.46159	21.95809	99.93194
0.4130222	23.45241	21.95301	129.5829
0.4130226	23.46159	21.95301	129.1643
0.577438	23.49833	22.04948	167.6843

EHD Data for Idemitsu Kosan FVC33B Under R-134a Pressure (~10 wt%)
(T=22.5 ± 0.5°C, P=2.19 bars; T=45°C, P=3.57 bars; T=65°C, P=4.94 bars)

0.577535	23.48455	22.04948	167.6843
0.8089721	23.5121	22.15611	206.1999
0.8093764	23.49373	22.1358	206.4866
1.133062	23.51669	22.17134	253.0092
1.133257	23.51669	22.1358	255.8743
1.133416	23.52128	22.1358	254.394
1.584758	23.53965	22.44553	314.3463
1.584902	23.58557	22.33382	313.2546
1.584916	23.53047	22.35921	312.0413
2.219383	23.61312	22.5877	374.2638
2.220047	23.59016	22.52169	374.9914
2.220369	23.58097	22.48615	376.0221
2.220933	23.59934	22.53692	374.3851
3.101862	23.66362	22.91266	440.0973
3.102302	23.66362	22.9025	440.3179
3.103205	23.67281	22.85681	440.3179
slope=0.731			
1.09E-02	43.24668	45.56347	3.694414
1.09E-02	43.14567	45.53808	3.694414
1.09E-02	43.15485	45.467	3.62421
1.09E-02	43.04924	45.34514	3.378416
1.41E-02	43.37524	45.29436	4.514992
1.41E-02	43.31096	45.29436	4.410163
1.41E-02	43.36147	45.30959	4.514992
1.41E-02	43.27423	45.24359	4.101376
2.04E-02	43.44871	45.06587	5.772757
2.05E-02	43.47167	45.19789	5.458309
2.05E-02	43.3982	45.15219	5.772757
2.84E-02	42.84262	44.98463	6.820894
2.84E-02	42.87017	44.97448	7.449728
2.84E-02	42.8564	44.98463	6.925678
2.85E-02	42.83803	44.90847	6.820894
0.0285279	42.87017	44.97956	7.449728
3.95E-02	43.08598	45.38576	9.162373
0.0396107	43.0722	45.36545	9.162373
0.0396226	43.0722	45.36545	9.162374
5.55E-02	43.1824	45.55331	12.5162
5.55E-02	43.18699	45.61932	13.35462
0.0556161	43.18699	45.52285	13.00528
7.62E-02	43.17781	45.54316	17.12743
7.63E-02	43.22831	45.50762	16.70821
7.64E-02	43.16862	45.51777	15.66026
7.64E-02	43.20995	45.45684	16.70821
0.1066046	43.23291	45.35529	20.48088
0.1066912	43.26046	45.44669	20.27125
0.106782	43.22831	45.36545	20.0617
0.1068389	43.20536	45.39083	20.48086
0.1496505	43.10434	45.1725	27.46664
0.1497509	43.17321	45.32483	27.18722

EHD Data for Idemitsu Kosan FVC33B Under R-134a Pressure (~10 wt%)
(T=22.5 ± 0.5°C, P=2.19 bars; T=45°C, P=3.57 bars; T=65°C, P=4.94 bars)

0.1503443	43.16403	45.27913	26.55853
0.2101069	43.06302	45.07603	35.28989
0.2101808	43.03088	45.02525	35.28989
0.2946163	43.03088	44.99987	46.06866
0.2947111	42.97578	44.91862	46.11519
0.4128161	42.87476	45.02525	58.7542
0.4128574	42.95282	45.04556	58.73094
0.577214	42.93904	44.8577	73.17098
0.577237	42.93904	44.82723	73.2059
0.8087216	43.54513	45.48731	87.81618
0.8087724	43.50381	45.46192	87.81618
1.132993	43.62319	45.7158	112.0786
1.133274	43.6186	45.58378	112.0786
1.585022	43.65533	45.76149	137.4545
1.585208	43.63237	45.75642	137.3143
2.219544	43.77012	45.82243	182.5346
2.219645	43.77471	45.85289	182.5346
2.219659	43.81144	45.86304	182.6306
3.10293	43.80226	45.86304	217.2006
3.106057	43.7793	45.83258	217.4885
slope=0.740			
0.0108752	60.02429	65.30994	2.017563
1.09E-02	59.9646	65.21854	1.911796
1.09E-02	59.93246	65.19316	1.911796
1.10E-02	60.04266	65.26424	2.017563
1.42E-02	60.15285	65.41657	2.44066
1.42E-02	60.16204	65.45211	2.44066
0.0204077	59.95082	65.01545	3.075313
2.06E-02	59.97378	65.00529	3.075313
2.85E-02	59.72584	64.99006	3.815738
2.85E-02	59.71206	64.95451	3.921497
2.85E-02	59.72584	65.00529	4.133015
3.97E-02	59.80389	65.16777	4.767684
3.97E-02	59.80389	65.09161	4.556153
0.0398166	59.81308	65.2287	4.767684
5.56E-02	59.49166	64.79711	6.671506
5.57E-02	59.47789	64.82758	6.671506
7.63E-02	59.56054	64.96975	8.998394
7.63E-02	59.60186	64.95451	8.363857
7.64E-02	59.58809	64.98498	8.363867
7.64E-02	59.57891	64.99513	7.940804
0.1066168	59.51003	64.87835	10.26761
0.106645	59.7993	65.20839	10.90218
0.1066587	59.61105	64.96975	11.11368
0.1067448	59.61564	65.00529	10.76114
0.106782	59.82685	65.2287	10.90218
0.1497509	60.12071	65.54858	14.07496
0.1497753	60.07479	65.49781	14.28654
0.1498622	60.10694	65.53336	14.07496

EHD Data for Idemitsu Kosan FVC33B Under R-134a Pressure (~10 wt%)
(T=22.5 ± 0.5°C, P=2.19 bars; T=45°C, P=3.57 bars; T=65°C, P=4.94 bars)

0.1498794	59.9646	65.42165	13.93398
0.2101519	60.23091	65.55367	19.85617
0.2102887	60.18959	65.51812	19.71517
0.2947742	60.27223	65.59936	25.49586
0.2947844	60.3457	65.61459	25.77783
0.2949052	60.27682	65.44196	27.61059
0.2949637	60.26305	65.4318	27.54012
0.2949732	60.25387	65.34548	26.55325
0.4131235	60.19877	65.12207	34.30695
0.5775058	60.31356	65.26933	43.57503
0.5777169	60.30897	65.43688	43.57503
0.8087397	60.33652	65.29979	56.92875
0.8092771	60.35947	65.37595	56.92875
1.133213	60.42376	65.56889	69.68102
1.133844	60.4008	65.5232	69.99808
1.585709	60.44212	65.65014	84.40121
1.585896	60.4559	65.65521	84.33079
2.222243	60.50181	65.53336	106.4435
2.223127	60.4559	65.56889	106.5843
3.105556	60.56609	65.17793	131.3299
3.107602	60.50181	65.3201	131.1891
3.108382	60.52477	65.36072	130.8724
slope=0.765			

EHD Data for Idemitsu Kosan FVC32B Under R-134a Pressure (~20 wt%)
(T=22.0 ± 0.5°C, P=3.63 bars; T=45°C, P=6.12 bars; T=65°C, P=6.73 bars)

Software version	2		
Lubricant name	Idemitsu Kosan FVC32		
Viscosity	0		
Oil refractive index	1.432		
Spacer type	Silica		
Ball diameter	0.01905		
Disc track radius	0.04415		
Trigger point	72		
Comments	Idemitsu Kosan FVC32B under R-134a pressure		
5/15/98 Temperature	45	65°C Load=20N	
M.R.=0.140 Trig. Pt.=72			
Avg. Band Top=241 Bottom=287			
Spacer Layer Film Thickness=485.7			
R.I.25°C=1.4394 45°C=1.4321 65°C=1.4256			
Disc #374			
Number of logged d	149		
Disc Speed (m/s)	Pot Temp (°C)	Lube Temp (°C)	Film (nm)
9.44E-03	23.48914	22.12057	4.612782
9.44E-03	23.45241	22.07487	4.612818
9.49E-03	23.46618	22.05456	3.983798
9.50E-03	23.47996	22.07995	4.193465
9.52E-03	23.47537	22.02409	4.193465
1.43E-02	23.47537	22.13072	5.451444
1.44E-02	23.48914	22.12057	5.870765
2.08E-02	23.47537	22.15611	7.338404
0.0208538	23.49373	22.12564	7.548027
2.73E-02	23.46618	22.12564	9.330116
2.73E-02	23.47537	22.14088	9.330116
2.73E-02	23.47996	22.12564	9.225288
3.86E-02	23.47996	22.08502	12.23024
3.86E-02	23.44782	22.08502	11.74108
3.87E-02	23.47537	22.06471	11.74108
5.49E-02	23.48914	22.06979	16.70245
5.49E-02	23.4019	22.07487	17.12174
5.49E-02	23.46618	22.10533	15.88723
0.054906	23.44782	22.07995	16.56269
7.73E-02	23.47996	22.53185	21.48882
7.73E-02	23.30089	21.89716	20.2183
7.74E-02	23.49373	22.54708	21.5936
7.75E-02	23.28252	21.86669	21.61568
0.1065974	23.30548	21.87684	26.3668
0.1066362	23.27793	21.87177	27.06547
0.1503406	23.30089	21.86669	32.37512
0.1503897	23.27793	21.86669	32.16554
0.2101215	23.27334	21.89208	42.08506
0.2101661	23.2917	21.88192	42.01522
0.2942051	23.26875	21.87684	53.67931
0.2944508	23.26875	21.86161	54.00525
0.4126075	23.25497	21.80576	70.22913
0.412641	23.25497	21.81084	70.5084
0.5777066	23.26875	21.80068	85.56497

EHD Data for Idemitsu Kosan FVC32B Under R-134a Pressure (~20 wt%)
(T=22.0 ± 0.5°C, P=3.63 bars; T=45°C, P=6.12 bars; T=65°C, P=6.73 bars)

0.5779788	23.27334	21.80576	85.51846
0.8077972	23.25956	21.8413	106.1083
0.8079384	23.24579	21.84638	106.4572
1.13278	23.25497	21.85653	133.808
1.133228	23.25956	21.85146	134.5754
1.584537	23.4019	22.19165	168.0984
1.585631	23.37894	22.19165	168.1939
1.585887	23.32844	22.06979	169.6279
2.21844	23.44782	22.3389	207.8605
2.21894	23.42486	22.27289	208.2904
3.102807	23.49373	22.58262	246.9374
3.104046	23.48914	22.54708	246.9374
3.10505	23.48455	22.48615	246.9374
3.105283	23.44323	22.36429	248.2748
slope=0.708			
9.46E-03	42.00237	44.58351	2.096774
9.46E-03	42.46611	44.42611	2.317672
9.51E-03	42.48907	44.47688	2.317672
9.51E-03	42.17685	44.60382	2.096774
1.43E-02	41.16211	44.53781	2.935459
1.44E-02	42.16766	45.76149	3.145138
1.44E-02	41.18507	44.55812	2.935459
2.07E-02	43.29259	45.37053	3.774112
2.08E-02	43.19617	45.19789	3.774112
2.08E-02	43.47626	45.61425	4.088635
2.08E-02	43.53136	45.7158	4.088635
2.73E-02	41.69473	43.92343	5.032106
2.73E-02	42.08501	44.12653	4.612798
2.73E-02	41.72687	43.94374	5.032106
3.86E-02	41.24935	44.82723	6.709408
3.87E-02	41.30904	44.85262	6.499741
0.0387349	41.39628	44.99479	6.290092
5.48E-02	41.63504	45.38068	8.91082
5.49E-02	41.7682	45.38576	8.91082
5.49E-02	41.68095	45.30959	8.805968
7.76E-02	42.53499	45.94429	11.11212
7.76E-02	42.5809	45.95952	11.11207
0.1067146	42.75079	45.88843	14.18685
0.1068566	42.66814	45.85289	13.90736
0.1504272	42.87476	45.76149	17.26147
0.1505104	42.962	45.85797	17.54099
0.2100387	43.24209	46.22355	21.2443
0.2102812	43.16862	46.18293	21.24434
0.2943909	43.40279	45.79704	27.25306
0.2946338	43.33851	46.122	27.11329
0.4126099	43.4533	46.08646	34.93785
0.4128494	43.46249	46.05599	35.00769
0.5782295	43.31556	45.72087	44.43792
0.5782637	43.35229	45.83258	44.22835

EHD Data for Idemitsu Kosan FVC32B Under R-134a Pressure (~20 wt%)
(T=22.0 ± 0.5°C, P=3.63 bars; T=45°C, P=6.12 bars; T=65°C, P=6.73 bars)

0.8080471	42.97578	45.34514	56.73012
0.8084858	43.11812	45.57363	56.59042
1.133818	42.73243	44.99987	74.39631
1.134068	42.04828	44.1113	72.53448
1.1342	42.53958	44.812	74.60574
1.134774	42.64978	45.41114	73.19054
1.135317	42.71406	45.50762	73.15544
1.586294	43.75175	46.20832	90.20236
1.58803	42.49825	45.00494	90.72843
1.588995	42.51662	45.03033	90.72845
1.589483	43.79767	46.19816	90.02702
2.223385	42.53958	44.95417	110.4008
2.223686	42.5304	44.94909	110.4008
2.223718	43.89869	46.54851	108.0866
2.224592	42.49366	44.89832	110.5059
2.225773	43.86195	46.53328	108.1919
3.108389	42.61763	44.95417	137.0078
3.108564	42.77375	45.10142	136.1666
3.110536	42.65896	44.98463	136.6573
3.11259	42.66355	44.91862	136.9026
slope=0.714			
1.43E-02	58.79375	64.38075	1.942473
1.44E-02	58.84885	64.34013	1.942473
2.07E-02	58.17389	64.2589	2.574591
2.08E-02	58.16929	64.33506	2.574591
2.73E-02	59.00037	64.40614	3.41732
2.73E-02	59.30341	64.55339	3.206656
0.0386389	60.48804	65.29471	4.119662
3.87E-02	60.2906	65.17285	4.365456
3.88E-02	60.22632	65.14746	4.365456
5.49E-02	58.70651	65.59428	5.84025
0.0549637	58.77997	65.49781	5.84025
5.50E-02	58.72947	65.51812	5.84025
7.74E-02	58.82589	65.42673	7.209788
7.75E-02	58.80752	65.33533	7.315088
7.76E-02	58.80752	65.33533	7.279989
7.77E-02	58.88558	65.4318	7.209788
0.1065011	59.12893	65.7466	9.527213
0.106831	59.10597	65.71614	9.527213
0.1069194	59.06924	65.71614	9.31654
0.1504815	59.35851	65.7466	12.19568
0.1505456	59.29882	65.7263	12.05531
0.1505734	59.28964	65.75169	11.98509
0.1508295	59.32637	65.76692	12.19568
0.2103473	59.53299	65.6806	16.12809
0.2104183	59.55595	65.78723	16.26853
0.2104427	59.44116	65.91417	16.76003
0.2946403	59.62482	65.67552	20.7975
0.2948489	59.65237	65.772	20.48152

EHD Data for Idemitsu Kosan FVC32B Under R-134a Pressure (~20 wt%)
(T=22.0 ± 0.5°C, P=3.63 bars; T=45°C, P=6.12 bars; T=65°C, P=6.73 bars)

0.4131167	59.56513	65.9751	26.58991
0.4131876	59.56513	66.04618	26.80053
0.5782518	59.45493	65.56889	34.12519
0.5786452	59.52381	65.93448	33.7508
0.5786737	59.53758	65.59936	33.82101
0.8087282	59.4733	65.71614	43.33258
0.8090952	59.51003	65.69583	43.43785
1.135011	59.61564	65.772	55.0886
1.135107	59.50544	65.65014	55.01844
1.13525	60.04266	65.85323	57.65085
1.588012	60.21254	66.00048	71.68472
1.588461	60.18499	65.85831	71.96533
2.224554	59.88195	65.32517	88.10069
2.224963	59.65696	64.84281	88.45139
2.225329	59.77634	65.17793	88.3111
3.109283	59.32178	64.13703	107.2478
3.109617	59.42279	64.34521	106.7569
3.111251	59.46871	64.45184	106.4062
slope=0.750			

EHD Data for Idemitsu Kosan FVC32B Under R-134a Pressure (~40 wt%)
(T=22.6 ± 0.4°C, P=5.36 bars; T=45°C, P=8.32 bars; T=65°C, P=12.26 bars)

Software version	2		
Lubricant name	Idemitsu Kosan FVC32		
Viscosity	0		
Oil refractive index	1.426		
Spacer type	Silica		
Ball diameter	0.01905		
Disc track radius	0.04077		
Trigger point	434		
Comments	Idemitsu Kosan FVC32B under R-134a pressure		
5/30/98 Temperature	45	65°C Load=20N	
M.R.=0.142 Trig. Pt.=434			
Avg. Band Top=241 Bottom=290			
Spacer Layer Film Thickness=485.2			
R.I.25°C=1.4394 45°C=1.4321 65°C=1.4256			
Disc #395			
Number of logged data	130		
Disc Speed (m/s)	Pot Temp (°C)	Lube Temp (°C)	Film (nm)
9.94E-03	23.81055	22.47599	1.467716
9.94E-03	23.81514	22.4963	1.25802
9.97E-03	23.79219	22.49122	1.467716
1.00E-02	23.81514	22.47599	1.25802
1.45E-02	23.8381	22.51661	1.782223
1.45E-02	23.82433	22.50138	1.782223
2.04E-02	23.8381	22.53692	2.166625
2.04E-02	23.84728	22.51661	2.236501
2.04E-02	23.86106	22.46584	2.166625
2.79E-02	23.87483	22.55215	2.865534
2.80E-02	23.84269	22.542	2.865534
3.84E-02	23.86565	22.55215	3.564409
3.84E-02	23.88861	22.542	3.564432
3.84E-02	23.86106	22.55215	3.564409
5.49E-02	23.81973	22.58262	4.822416
5.50E-02	23.8932	22.57247	4.822416
5.50E-02	23.88402	22.4963	4.403076
7.58E-02	23.8932	22.59785	5.870745
7.59E-02	23.77382	22.59785	5.894003
7.60E-02	23.86106	22.52677	5.894003
0.1071161	23.86565	22.61308	7.862475
0.1073097	23.87943	22.6334	7.96731
0.1073498	23.87483	22.6334	8.107052
0.1505024	23.88402	22.61816	10.9024
0.1505696	23.87943	22.63847	10.69275
0.1506832	23.83351	22.6334	10.62287
0.2101156	23.88402	22.63847	13.34825
0.2102657	23.84728	22.55215	13.13858
0.2938445	23.85647	22.64863	17.50599
0.2938897	23.87943	22.64355	17.61077
0.4121358	23.81973	22.44553	22.2224
0.4124409	23.84269	22.44045	22.43203
0.5765606	23.78759	22.47599	27.98655
0.5768626	23.82892	22.4963	27.98655
0.8083162	23.8381	22.50646	34.90284
0.8090213	23.81973	22.51661	34.74567
1.131678	23.84728	22.56739	43.39006
1.132167	23.8381	22.52677	43.39006

EHD Data for Idemitsu Kosan FVC32B Under R-134a Pressure (~40 wt%)
(T=22.6 ± 0.4°C, P=5.36 bars; T=45°C, P=8.32 bars; T=65°C, P=12.26 bars)

1.585246	23.87024	22.60801	54.21587
1.585562	23.85188	22.60293	54.18096
2.222003	23.84269	22.63847	69.15964
2.224546	23.83351	22.59785	69.36909
2.225414	23.84728	22.64355	69.22945
3.105454	24.20543	23.02944	81.51717
slope=0.735			
1.45E-02	42.25031	46.17785	1.158832
1.45E-02	41.73146	46.00014	1.26417
1.45E-02	41.74524	46.04583	1.26417
2.04E-02	42.58549	45.7158	1.685573
2.05E-02	42.57172	45.90874	1.685573
2.79E-02	41.66259	45.86812	2.212314
2.80E-02	41.77279	45.94429	2.317638
3.84E-02	41.53862	45.3251	2.739032
3.84E-02	41.50188	46.26417	2.739032
3.85E-02	41.42383	46.13723	2.844405
5.48E-02	43.41657	46.43173	3.792533
5.51E-02	43.3982	45.42157	3.792533
5.52E-02	43.50381	45.63483	3.652022
7.58E-02	42.61304	45.97983	5.197122
7.59E-02	42.62223	45.90874	4.845989
7.60E-02	42.64059	45.96967	4.951313
0.1074158	42.57172	45.69041	7.163533
0.1074783	42.50744	45.56855	7.163515
0.1075093	42.5809	45.60917	6.882614
0.1509748	42.41561	45.48731	8.919208
0.1509863	42.43856	45.56347	9.059654
0.2105846	42.34214	45.23851	11.58773
0.2106687	42.34214	45.27913	12.21975
0.2945486	42.26408	45.3756	16.29252
0.2946337	42.34673	45.37053	16.22228
0.4131058	42.17685	45.29944	20.01401
0.4131896	42.15848	45.14204	20.05641
0.4132408	42.12634	45.35022	20.09134
0.5777885	42.18143	45.32991	25.18631
0.5783311	42.17225	45.22836	25.13951
0.8107594	42.1998	45.38068	32.33561
0.8108761	42.1998	45.43145	32.2303
1.13453	42.19521	45.42638	40.75937
1.134571	42.27786	45.43653	40.75937
1.588247	42.31459	45.32991	51.39296
1.589064	42.30541	45.37053	51.39296
2.231067	42.25949	44.88308	67.6032
2.232714	42.30541	44.92878	67.49797
2.232859	42.34214	44.95417	67.49797
3.114925	42.87936	45.48223	80.75813
3.114925	42.88395	45.50254	80.75813
3.116925	42.636	45.19789	80.86336
3.117166	42.62682	45.24359	80.93349
3.118243	42.82426	45.40607	80.65289

EHD Data for Idemitsu Kosan FVC32B Under R-134a Pressure (~40 wt%)
(T=22.6 ± 0.4°C, P=5.36 bars; T=45°C, P=8.32 bars; T=65°C, P=12.26 bars)

slope=0.779			
5.51E-02	57.53106	65.99033	1.904279
5.52E-02	57.54025	65.772	2.186378
5.52E-02	57.80656	65.14265	1.904279
7.62E-02	58.77538	65.39146	2.750557
7.62E-02	58.75242	65.42699	2.750557
0.1075633	55.823	64.55847	3.808496
0.1075633	56.0434	64.42138	3.808496
0.1077029	57.76982	64.90882	3.596974
0.1077349	57.84788	65.06622	3.314832
0.1079183	57.79279	64.95451	3.491153
0.1080146	56.0434	64.59909	3.808496
0.1081998	56.08931	64.60416	3.808496
0.1509871	59.29882	65.82785	5.289534
0.1510658	59.37228	65.74153	5.007418
0.1511028	59.28045	66.06142	4.866379
0.2107426	59.55595	66.19851	7.264214
0.2109021	59.45493	65.98017	7.546267
0.2954347	58.45856	65.90909	9.200106
0.2955723	58.35295	65.8177	9.445882
0.29562	58.45856	65.86847	9.375641
0.4126501	59.53299	65.25409	12.90576
0.4143242	58.49989	66.18327	12.92193
0.4144115	58.33459	66.03603	12.92195
0.4144744	58.48152	66.16296	12.8049
0.5774615	58.20144	65.66029	17.55981
0.5776496	58.05909	65.59936	17.34827
0.5777422	58.1096	65.66029	17.84185
0.5779331	58.04073	65.5892	17.13674
0.8100885	58.40805	65.71107	22.70703
0.810128	58.35755	65.68568	22.80104
0.8101389	58.24735	65.73645	22.4955
1.134266	58.56417	65.72122	29.12296
1.13459	58.4953	65.72122	28.98193
1.589365	58.60549	65.30486	36.06693
1.589592	58.55039	65.44196	36.27842
2.224698	59.04628	64.75141	46.46406
2.225085	58.8764	64.78696	46.74601
2.226456	58.78456	64.99513	45.82972
3.10621	59.28505	64.13196	58.51569
3.109874	59.2024	64.44676	58.16333
3.111296	59.24831	64.36552	58.37474
slope=0.862			

EHD Data for Idemitsu Kosan FVC68B Under R-134a Pressure (~10 wt%)
(T=23 ± 0.5°C, P=2.12 bars; T=45°C, P=3.43 bars; T=65°C, P=4.74 bars)

Software version	2			
Lubricant name	Idemitsu Kosan FVC68			
Viscosity	0			
Oil refractive index	1.428			
Spacer type	Silica			
Ball diameter	0.01905			
Disc track radius	0.044			
Trigger point	334			
Comments	Idemitsu Kosan FVC32B under R-134a pressure			
5/6/98 Temperature	45 65°C Load=20N			
M.R.=0.142 Trig. Pt.=334				
Avg. Band Top=234 Bottom=283				
Spacer Layer Film Thickness=475.9				
R.I.25°C=1.4420 45°C=1.4350 65°C=1.4281				
Disc #386				
Number of logged d	133			
Disc Speed (m/s)	Pot Temp (°C)	Lube Temp (°C)	Film (nm)	
9.39E-03	23.88402	22.70956	14.80293	
9.40E-03	23.8932	22.71464	14.48908	
9.44E-03	23.92993	22.71464	15.11677	
1.43E-02	23.90697	22.73495	20.10313	
1.43E-02	23.92075	22.73495	19.71956	
1.43E-02	23.87943	22.72987	19.69633	
2.06E-02	23.91616	22.80603	25.57729	
2.06E-02	23.91616	22.78064	25.99567	
2.07E-02	23.92075	22.77049	25.71676	
2.07E-02	23.92993	22.78064	25.78645	
2.07E-02	23.91616	22.80603	25.47265	
2.87E-02	23.93452	22.85173	32.79411	
2.88E-02	23.93452	22.82126	33.03815	
0.0287761	23.92075	22.79588	32.79411	
0.0383857	23.92534	22.86696	41.47424	
0.0384498	23.92534	22.89743	40.2194	
3.85E-02	23.93452	22.87204	40.2194	
5.46E-02	23.91616	22.88219	52.4884	
5.46E-02	23.92993	22.86188	52.55822	
5.47E-02	23.92534	22.90758	51.93084	
7.72E-02	23.92075	22.98882	67.33383	
0.0771846	23.92993	22.99898	67.40351	
0.0772019	23.92075	22.98882	66.77634	
0.1078735	23.92534	23.0396	84.73326	
0.1078997	23.92993	23.05483	84.24558	
0.1079325	23.93912	23.05483	84.31522	
0.1497959	23.91616	22.9482	102.7267	
0.1498794	23.88402	22.96343	103.1446	
0.1498828	23.92075	23.04975	103.1937	
0.149894	23.90697	22.94312	102.5178	
0.210973	23.92534	23.12592	132.9987	
0.2110554	23.92534	23.13607	133.6253	
0.2948566	23.90697	23.21223	176.1416	
0.2948742	23.90697	23.2427	175.4738	
0.2949352	23.89779	23.22746	175.4738	
0.4127232	23.56261	22.17642	237.0015	

EHD Data for Idemitsu Kosan FVC68B Under R-134a Pressure (~10 wt%)
(T=23 ± 0.5°C, P=2.12 bars; T=45°C, P=3.43 bars; T=65°C, P=4.74 bars)

0.4128826	23.57179	22.17134	238.0502
0.5773237	23.57638	22.27797	296.7855
0.5776899	23.57638	22.2932	296.9761
0.8078604	23.60393	22.34905	367.584
0.808245	23.59934	22.31351	367.7445
0.8084146	23.57179	22.30843	368.5061
1.130682	23.63607	22.55723	446.3445
1.131003	23.64066	22.60801	445.9816
1.583675	23.67281	23.01421	540.1977
1.583778	23.66362	22.80095	540.4177
2.219713	23.70035	23.3544	631.1153
2.220984	23.70035	23.03452	630.3823
2.221233	23.69576	23.06499	630.8221
2.223205	23.66821	23.08529	631.7017
3.107975	23.72331	23.28332	712.8192
slope=0.699			
9.47E-03	43.47167	46.46727	6.910606
9.47E-03	43.26964	46.47235	6.910606
9.48E-03	42.8564	46.29463	6.492115
0.0142227	44.20173	46.09661	8.793786
1.43E-02	44.18795	46.14231	8.793786
2.06E-02	42.13552	45.04556	12.44263
2.06E-02	41.68555	44.46165	12.54727
2.07E-02	41.64882	44.32455	12.58213
2.07E-02	41.94267	44.8577	12.58211
2.88E-02	44.51855	46.22355	16.76665
2.88E-02	44.62875	46.11184	17.25478
3.84E-02	44.52773	45.97983	20.81147
3.84E-02	44.64711	45.97475	20.4628
5.46E-02	41.78197	43.76603	25.76256
5.46E-02	41.44678	43.80665	26.25068
7.70E-02	43.49004	44.75107	33.36289
7.72E-02	43.29719	44.50227	33.15372
0.107743	44.27979	46.18801	44.13438
0.1077958	43.96297	45.533	43.40242
0.149083	41.64422	45.2639	50.79148
0.2108769	42.92068	45.72087	63.89513
0.2108783	42.92986	45.66502	63.82541
0.2946788	42.97119	45.65487	78.18058
0.2947528	42.93904	45.65994	77.90186
0.4123079	42.87936	45.43653	95.8765
0.4123656	42.79671	45.27913	95.45853
0.4126104	43.03547	44.99987	96.86014
0.4133145	43.0171	44.95417	96.96463
0.5773147	43.02169	45.05572	123.0818
0.5775226	43.0171	45.03541	122.6988
0.8078615	43.15026	45.37053	165.3279
0.8082552	43.08598	45.34006	165.7095
1.13069	43.38443	45.47208	204.0898
1.13123	43.29259	45.33498	204.3441
1.583575	43.54513	45.63456	251.0671
1.583788	43.73339	46.00014	250.0184

EHD Data for Idemitsu Kosan FVC68B Under R-134a Pressure (~10 wt%)
(T=23 ± 0.5°C, P=2.12 bars; T=45°C, P=3.43 bars; T=65°C, P=4.74 bars)

2.219755	41.94727	44.44134	316.9208
2.219991	42.08042	44.63936	314.9836
3.100919	42.53499	45.13188	375.7732
3.101376	42.44775	44.94401	377.7097
3.101832	42.2549	44.65967	380.0092
slope=0.690			
9.44E-03	59.38606	64.91389	3.071814
9.48E-03	59.40443	64.92405	3.071814
1.43E-02	59.72124	65.12715	4.506804
0.014344	59.71206	65.11192	4.506804
2.06E-02	60.0197	65.772	5.971575
2.07E-02	60.07939	65.71614	5.971575
2.87E-02	59.7993	64.90374	7.645564
2.88E-02	59.73502	64.87328	7.645564
3.85E-02	59.15648	65.09161	9.947255
3.85E-02	59.0922	65.0256	10.57496
3.85E-02	59.12893	65.10176	9.947255
5.46E-02	58.74324	64.82758	13.12134
5.46E-02	58.72487	64.71079	13.12134
7.71E-02	58.72947	64.84281	17.20126
7.71E-02	58.83966	65.24393	17.79403
0.0771815	58.85344	65.22363	16.25976
7.72E-02	58.72487	64.84789	16.60846
0.1076972	58.78456	65.14746	21.2809
0.1079154	58.75702	65.07638	21.00197
0.1081489	58.72028	65.11192	21.3855
0.1497552	59.83603	65.71107	27.13848
0.1498454	59.84522	65.71614	27.34766
0.149863	59.84522	65.78723	27.20819
0.2110575	59.8544	65.60951	33.97171
0.2111398	59.82226	65.56382	34.04144
0.2947415	59.77634	65.44196	43.13969
0.2950054	59.76257	65.44196	43.24425
0.412734	59.67992	65.25409	56.628
0.4128412	59.68451	65.34041	56.83709
0.5778278	59.70747	65.27948	71.47247
0.5779166	59.71206	65.29471	71.26343
0.8084128	59.70288	65.11192	87.70712
0.80901	59.71665	65.0256	87.56778
1.132059	59.91409	65.09669	111.9933
1.132251	59.91409	65.19823	111.9933
1.586122	60.02429	65.38611	145.7428
1.586139	60.02888	65.34041	145.7428
2.220727	60.22173	65.46735	184.9196
2.22136	60.22632	65.48766	184.9196
3.105972	60.24928	65.33533	223.4449
3.10867	60.24468	65.36072	223.3486
slope=0.731			

EHD Data for Idemitsu Kosan FVC68B Under R-134a Pressure (~15 wt%)
(T=23.0 ± 0.5°C, P=3.01 bars; T=45°C, P=5.15 bars; T=65°C, P=6.67 bars)

Software version	2		
Lubricant name	Idemitsu Kosan FVC68		
Viscosity	0		
Oil refractive index	1.428		
Spacer type	Silica		
Ball diameter	0.01905		
Disc track radius	0.04438		
Trigger point	390		
Comments	Idemitsu Kosan FVC68B under R-134a pressure		
5/9/98 Temperature	45	65°C	Load=20N
M.R.=0.144 Trig. Pt.=390			
Avg. Band Top=234 Bottom=280			
Spacer Layer Film Thickness=477.7			
R.I.25°C=1.4420 45°C=1.4350 65°C=1.4281			
Disc #382			
Number of logged d	141		
Disc Speed (m/s)	Pot Temp (°C)	Lube Temp (°C)	Film (nm)
9.48E-03	24.03554	22.67402	11.19215
9.62E-03	24.0585	22.6994	11.19215
1.44E-02	24.07227	22.67909	15.48128
1.44E-02	24.06309	22.70448	16.00433
1.44E-02	24.05391	22.70956	15.02797
2.08E-02	24.02176	22.69433	22.07141
2.09E-02	24.02176	22.66386	22.07141
2.75E-02	23.9483	22.64863	26.25526
2.75E-02	23.99881	22.65878	26.25526
3.87E-02	24.109	22.75526	31.48471
3.89E-02	24.08146	22.75018	31.48471
5.50E-02	24.06768	22.85173	40.47853
5.51E-02	24.12278	22.81111	39.43287
5.51E-02	24.04931	22.80603	40.40886
5.51E-02	24.11819	22.82634	40.16484
5.52E-02	24.11819	22.82126	39.43287
7.62E-02	24.07686	22.8365	44.45218
7.63E-02	24.11819	22.80095	44.03392
7.63E-02	24.11819	22.84665	44.55675
0.1070689	24.09982	22.94312	56.16261
0.1071375	24.12737	22.97359	56.99895
0.1494067	24.03554	23.18177	73.30627
0.1495673	24.03095	23.09037	73.51536
0.1495847	24.06309	22.96851	73.72438
0.2112559	23.98962	23.27316	91.21198
0.211332	24.01258	23.15638	91.1191
0.2114013	24.08605	22.75526	91.00298
0.2941581	23.96207	23.32394	116.0075
0.294205	23.99422	23.30871	115.9379
0.2942393	24.0034	23.25285	114.1969
0.2943864	24.14115	22.86188	116.2861
0.2949311	24.07227	22.92281	114.963
0.4131412	23.68199	22.34398	146.8115

EHD Data for Idemitsu Kosan FVC68B Under R-134a Pressure (~15 wt%)
(T=23.0 ± 0.5°C, P=3.01 bars; T=45°C, P=5.15 bars; T=65°C, P=6.67 bars)

0.4131987	23.7325	22.35413	146.6723
0.5777761	23.7325	22.36429	202.6635
0.5778807	23.70954	22.39983	202.1866
0.8080956	23.70954	22.56739	247.718
0.8087099	23.75086	22.61308	246.6217
0.8087397	23.75545	22.64863	246.431
0.8087942	23.72331	22.58262	247.861
1.130771	23.78759	22.57754	300.7191
1.131169	23.76004	22.57754	301.8624
1.581965	23.76923	22.65371	380.8719
1.582348	23.81973	22.79588	380.3273
2.219898	23.84728	22.80603	453.3419
2.220757	23.85647	23.05483	450.9229
3.103654	23.98044	23.55243	511.5012
3.103842	23.93912	23.42041	511.9413
3.104529	23.90238	23.25285	513.5619
slope=0.665			
9.55E-03	43.55432	45.96967	5.542654
9.55E-03	43.53136	45.97475	5.542654
1.45E-02	43.25586	45.63456	7.635145
1.45E-02	43.27882	45.62948	7.635145
2.09E-02	42.99414	45.12173	10.14605
2.09E-02	43.23291	45.51777	9.727503
0.0208848	42.96659	45.11157	10.14605
0.0209104	43.22831	45.49746	9.727503
2.74E-02	43.26964	45.48731	12.02913
2.75E-02	43.27882	45.467	12.02913
3.88E-02	43.25586	45.4213	15.79511
3.88E-02	43.28341	45.49746	15.58589
3.89E-02	43.24209	45.49239	15.58589
5.52E-02	43.22831	45.74626	20.32803
5.52E-02	43.22372	45.59394	19.3517
5.52E-02	43.1824	45.72595	19.3517
7.62E-02	43.14108	45.76657	21.4438
7.63E-02	43.10434	45.7818	23.18711
7.63E-02	43.19158	45.68533	22.699
0.1071605	42.71406	45.48731	25.62764
0.1072423	42.70028	45.467	25.73228
0.14938	42.83803	45.45177	32.60028
0.1498886	42.84262	45.45177	32.73973
0.2113602	42.93904	45.52285	42.15168
0.2115054	42.92527	45.47715	41.87283
0.2943999	42.99414	45.55839	55.32618
0.2945027	43.02169	45.58378	55.04737
0.413376	43.10434	45.62948	70.27515
0.4136063	43.10893	45.58378	70.48419
0.5783891	43.25127	45.59394	88.28609
0.5785945	43.27882	45.59394	87.93777
0.5790184	43.22372	45.61932	88.35579
0.8096315	43.45789	45.66502	108.5031

EHD Data for Idemitsu Kosan FVC68B Under R-134a Pressure (~15 wt%)
(T=23.0 ± 0.5°C, P=3.01 bars; T=45°C, P=5.15 bars; T=65°C, P=6.67 bars)

0.809769	43.49004	45.6244	108.3638
0.8098995	43.5084	45.74118	108.3638
1.132449	43.6186	45.77673	140.881
1.132681	43.65074	45.89351	140.6721
1.13387	43.59105	45.76149	140.881
1.58466	43.66451	46.15246	181.6785
1.585058	43.72421	46.2794	181.3923
2.222761	43.83899	46.20832	221.6891
2.223572	43.70125	46.30987	221.7368
2.223731	43.88032	46.33525	221.26
3.106235	43.99511	46.53328	264.6376
3.106785	43.93542	46.30479	264.7329
3.108792	43.91705	46.44696	264.9236
slope=0.663			
9.48E-03	60.94238	65.03521	2.491812
9.51E-03	60.88269	65.05045	2.491812
9.52E-03	60.33266	65.89304	2.315732
1.44E-02	60.0214	65.78723	3.442708
0.0144177	60.93875	65.79739	3.442708
2.09E-02	60.37784	65.12769	4.7238737
2.10E-02	60.43294	65.09723	4.738737
2.74E-02	61.35125	66.39653	6.400888
0.02748	61.3237	66.46761	6.400888
3.87E-02	60.00133	64.47215	8.57018
3.90E-02	60.00592	64.49754	8.57018
0.0551527	60.93801	65.21347	10.10558
5.54E-02	60.88291	65.1627	10.10558
7.63E-02	60.63037	65.00076	12.79578
7.65E-02	60.68089	65.04137	12.79578
0.1073528	59.43464	64.86819	16.02111
0.1074418	59.97548	65.11672	16.59863
0.107548	59.93875	65.11672	16.59863
0.1075997	59.45301	64.87835	16.02111
0.1489247	59.09946	65.20332	20.92249
0.1500058	59.15915	65.23885	20.92249
0.2114281	59.46775	65.73645	27.47099
0.2117398	59.31163	65.65521	27.36541
0.2944441	60.53854	66.20866	37.2928
0.2946669	60.53854	66.23913	37.1872
0.2947421	60.48804	66.1782	37.18717
0.4133558	60.33652	66.00556	47.39476
0.4136254	60.3457	65.98525	47.21877
0.578208	60.20336	65.6349	60.31039
0.5785506	60.16204	65.57905	60.48634
0.8092825	60.13449	65.96494	75.51039
0.8096527	60.12071	66.00556	75.72151
0.8098899	60.11153	65.9751	75.61594
1.132727	60.00133	65.71107	89.96844
1.132827	60.07479	65.78723	90.07395
1.133835	59.27586	64.89867	92.12842

EHD Data for Idemitsu Kosan FVC68B Under R-134a Pressure (~15 wt%)
 (T=23.0 ± 0.5°C, P=3.01 bars; T=45°C, P=5.15 bars; T=65°C, P=6.67 bars)

1.134197	59.21158	64.78696	92.05806
1.586085	59.84063	65.87862	112.3148
1.586372	59.73502	65.5892	113.5806
1.587207	59.78093	65.7263	113.44
2.224341	60.11153	66.08173	143.3219
2.226569	60.03347	66.05634	143.3219
2.227099	60.07479	66.03095	143.3219
3.111027	59.4733	64.98498	182.4964
3.111381	59.57431	65.10176	181.5331
3.11204	59.56972	65.20332	181.533
slope=0.737			

EHD Data for Idemitsu Kosan FVC68B Under R-134a Pressure (~30 wt%)
(T=22.5 ± 0.5°C, P=5.36 bars; T=45°C, P=8.74 bars; T=65°C, P=11.15 bars)

Software version	2		
Lubricant name	Idemitsu Kosan FVC68		
Viscosity	0		
Oil refractive index	1.428		
Spacer type	Silica		
Ball diameter	0.01905		
Disc track radius	0.04475		
Trigger point	488		
Comments	Idemitsu Kosan FVC68B under R-134a pressure		
10/14/98 Temperature	45	65C Load=20N	
M.R.=0.145 Trig. Pt.=488			
Avg. Band Top=237 Bottom=287			
Spacer Layer Film Thickness=487.3			
R.I.25°C=1.4420 45°C=1.4350 65°C=1.4281			
Disc #418			
Number of logged c	127		
Disc Speed (m/s)	Pot Temp (°C)	Lube Temp (°C)	Film (nm)
9.38E-03	23.79219	22.43029	3.979229
9.39E-03	23.77382	22.47091	4.049003
9.45E-03	23.75545	22.47599	4.049003
1.44E-02	23.80137	22.60801	5.235782
1.44E-02	23.80137	22.60293	5.340489
0.0144663	23.79219	22.542	5.131036
1.45E-02	23.76923	22.54708	5.131036
1.91E-02	23.80137	22.61816	6.073466
1.91E-02	23.81055	22.59278	6.282876
2.75E-02	23.80596	22.62324	7.853531
2.75E-02	23.80137	22.62324	7.958237
0.0389451	23.81055	22.61816	9.773129
0.0389863	23.79678	22.60293	9.947647
5.53E-02	23.80137	22.62832	12.77462
5.54E-02	23.82433	22.6334	12.66992
0.0767253	23.81973	22.67909	16.33441
7.67E-02	23.80137	22.65371	16.2646
0.1079296	23.79678	22.70448	21.0107
0.1079634	23.80137	22.67909	21.35969
0.150505	23.80137	22.70956	25.96588
0.1505835	23.78759	22.70956	26.17522
0.2112441	23.79678	22.75526	31.82778
0.2113906	23.79678	22.74002	32.17668
0.2947725	23.77841	22.72479	39.9918
0.2948166	23.76923	22.71971	39.88713
0.4134625	23.59934	22.24243	50.96862
0.413575	23.60393	22.2475	50.94537
0.5776191	23.60852	22.27289	64.33845
0.5779237	23.60852	22.26274	64.47794
0.8092044	23.61312	22.30336	82.5404
0.8093298	23.61312	22.33382	82.54041
1.134978	23.66821	22.42014	100.914
1.135386	23.64526	22.36429	100.914
1.587568	23.64985	22.47599	128.7236

EHD Data for Idemitsu Kosan FVC68B Under R-134a Pressure (~30 wt%)
(T=22.5 ± 0.5°C, P=5.36 bars; T=45°C, P=8.74 bars; T=65°C, P=11.15 bars)

1.588991	23.66821	22.47091	128.619
2.222402	23.71413	22.53185	174.6734
2.224424	23.70495	22.59278	174.9599
3.108158	23.75545	22.76033	211.0462
3.108418	23.75086	22.70956	211.5235
3.111469	23.7279	22.65371	212.287
3.112506	23.75086	22.69433	211.6189
slope=0.688			
9.40E-03	43.45427	45.9344	2.525431
9.44E-03	43.94919	46.08165	2.315041
9.51E-03	44.41753	46.70084	2.525431
0.0143965	42.4707	44.39564	3.156808
1.45E-02	41.63963	44.95925	2.946392
1.93E-02	42.89869	46.18828	3.718019
1.93E-02	43.165	46.37614	3.4725
2.75E-02	42.31363	45.04021	4.419478
2.75E-02	42.25853	44.96913	4.419478
3.90E-02	42.09879	45.27405	5.47174
3.90E-02	42.27327	45.45684	5.682158
3.91E-02	42.15388	45.33498	5.47174
5.55E-02	42.65437	45.77673	7.365722
5.55E-02	42.62223	45.84274	7.576191
7.69E-02	41.97482	45.04556	9.470067
7.69E-02	41.86003	44.9694	8.838803
7.69E-02	41.85543	44.9694	9.259675
0.1080177	43.18795	45.56374	12.31093
0.1080399	43.18336	45.57898	12.31093
0.1506342	43.4533	44.94401	15.36205
0.1506342	43.50381	44.95925	15.36205
0.2113444	43.03547	44.67998	19.57022
0.2114956	43.14108	44.74091	19.64039
0.2951054	42.82885	44.6089	24.83017
0.2955774	42.72783	44.57335	25.0406
0.4136903	42.68192	45.01002	30.44031
0.413904	42.71406	45.01002	30.44031
0.57835	42.67733	44.94909	38.64434
0.5785045	42.70028	44.95417	38.434
0.8100541	42.68651	44.86277	49.02063
0.8104183	42.70488	44.84246	48.81036
1.135198	42.69569	44.82215	61.35803
1.136265	42.66814	44.84754	61.35803
1.588276	42.64518	44.73076	78.28541
1.588954	42.64518	44.80184	79.29935
1.58896	42.63141	44.812	79.50952
1.589551	42.68651	44.78153	78.24818
2.223763	42.67273	44.57843	98.74429
2.225029	42.68192	44.58859	98.88439
2.225063	42.64059	44.64444	97.62337
2.225092	42.66355	44.62413	98.18383

EHD Data for Idemitsu Kosan FVC68B Under R-134a Pressure (~30 wt%)
(T=22.5 ± 0.5°C, P=5.36 bars; T=45°C, P=8.74 bars; T=65°C, P=11.15 bars)

3.109892	42.70028	44.55304	121.7884
3.111763	42.70488	44.57335	121.2982
3.112336	42.71406	44.54797	121.4733
slope=0.692			
9.47E-03	60.59824	66.38638	1.903386
0.0095583	57.70095	64.2589	2.009115
1.45E-02	59.44116	65.44196	2.326354
1.45E-02	59.42279	65.51812	2.326354
1.93E-02	59.2529	64.52293	2.855067
1.93E-02	59.07746	64.44649	2.678848
1.94E-02	59.20699	64.4163	2.855067
2.76E-02	59.83603	64.56355	3.595268
2.76E-02	57.98563	64.64986	3.595268
0.038944	59.5835	65.57905	4.864099
3.92E-02	58.04073	65.05099	4.86415
5.54E-02	59.51463	65.69076	6.027209
5.55E-02	59.51463	65.73645	6.555916
7.69E-02	59.40902	65.28455	7.719043
7.69E-02	59.38147	65.32517	8.03626
7.69E-02	59.45493	65.29471	7.824782
0.108058	59.2024	64.95451	10.0452
0.1081947	59.17026	64.95451	10.08044
0.1082734	59.11516	64.8225	10.2214
0.1503578	58.91772	64.62955	12.37127
0.1511203	58.91772	64.59909	12.75895
0.2116503	58.97282	64.42645	16.63552
0.2116967	59.02792	64.43661	16.70601
0.2118079	58.982	64.53308	16.82347
0.2953271	59.01414	64.20812	20.51189
0.295376	58.94068	64.2589	21.00526
0.4139251	59.14271	65.09161	25.6566
0.4139684	59.22995	65.36579	25.69185
0.5784908	58.94986	64.46707	32.56259
0.5788323	58.8764	64.47723	32.5626
0.8103459	58.92231	64.60925	40.66569
0.8115996	58.9269	64.53816	40.59525
1.136245	58.99578	64.7768	48.83824
1.136858	58.97741	64.75649	48.83824
1.589807	59.01414	64.84789	63.31401
1.589807	59.04628	64.83266	63.31401
1.590508	59.07843	64.78696	63.49013
2.226455	59.06465	64.39091	80.63867
2.226953	59.09679	64.50262	80.3218
3.113849	59.10597	64.29444	97.64215
3.11396	59.1473	64.18781	98.27572
3.114112	59.11516	64.23859	97.95893
slope=0.695			

EHD Data for Idemitsu Kosan FVC68B Under R-134a Pressure (~50 wt%)
(T=22.0 ± 0.2°C, P=5.84 bars; T=45°C, P=10.12 bars; T=65°C, P=14.81 bars)

Software version	2		
Lubricant name	Idemitsu Kosan FVC68		
Viscosity	0		
Oil refractive index	1.428		
Spacer type	Silica		
Ball diameter	0.01905		
Disc track radius	0.0444		
Trigger point	496		
Comments	Idemitsu Kosan FVC68B under R-134a pressure		
5/12/98 Temperature	45	65°C Load=20N	
M.R.=0.146 Trig. Pt.=496			
Avg. Band Top=237 Bottom=287			
Spacer Layer Film Thickness=491.4			
R.I.25°C=1.4420 45°C=1.4350 65°C=1.4281			
Disc #374			
Number of logged data	111		
Disc Speed (m/s)	Pot Temp (°C)	Lube Temp (°C)	Film (nm)
1.44E-02	23.25956	21.92254	1.56912
1.45E-02	23.27793	21.95809	1.743468
2.09E-02	23.36058	21.98347	1.952695
2.09E-02	23.36517	21.94285	1.882962
0.0209146	23.38354	22.01394	2.092177
2.74E-02	23.4019	22.02409	2.371125
2.74E-02	23.36058	22.0444	2.301392
0.0275171	23.39731	22.02409	2.405991
3.88E-02	23.41109	22.01902	3.068527
3.89E-02	23.41568	22.02409	2.929039
3.89E-02	23.39272	22.02409	2.929039
5.51E-02	23.42027	22.02409	3.870481
5.52E-02	23.41568	21.98855	3.870481
5.52E-02	23.42945	22.03933	3.765891
7.63E-02	23.41568	22.05964	5.125779
7.65E-02	23.3468	22.03933	5.230378
0.107225	23.42945	22.0901	6.276415
0.1073391	23.42486	22.10026	6.485605
0.1495321	23.46159	22.09518	7.531636
0.1496366	23.45241	22.10533	7.740831
0.1497339	23.44323	22.11041	7.740831
0.2097758	23.45241	22.12057	10.39065
0.209878	23.44323	22.12564	9.972249
0.2099275	23.44323	22.0901	10.46037
0.2943963	23.43404	22.09518	13.38907
0.2944286	23.41568	22.12564	13.45879
0.2944939	23.42945	22.0901	13.49364
0.4132737	23.39272	22.06471	16.94507
0.4133159	23.42945	22.12564	17.01477
0.4133314	23.43404	22.12057	16.94501
0.4134658	23.457	22.11549	16.87531
0.577826	23.30548	21.91239	22.80169
0.5781774	23.2917	21.90223	22.80169
0.809108	23.2917	21.96824	27.96066
0.8092849	23.24579	21.9327	27.82124

EHD Data for Idemitsu Kosan FVC68B Under R-134a Pressure (~50 wt%)
(T=22.0 ± 0.2°C, P=5.84 bars; T=45°C, P=10.12 bars; T=65°C, P=14.81 bars)

1.132286	23.33762	21.99363	34.72249
1.132652	23.31925	21.95301	35.2105
1.583242	23.34221	22.10026	43.08679
1.583405	23.38354	22.08502	42.9474
1.584354	23.32384	22.00378	43.08679
2.218869	23.39272	22.13072	52.49536
2.218869	23.36058	22.14088	52.49536
slope=0.715			
2.75E-02	43.67829	45.35022	1.67376
2.75E-02	44.03184	45.99506	1.569159
2.75E-02	43.61401	45.15219	1.673775
2.76E-02	43.4533	45.09126	1.882962
2.76E-02	44.04562	45.91382	1.569159
3.89E-02	43.03547	45.06587	2.301392
3.90E-02	44.06857	45.94936	2.719834
3.90E-02	43.39361	45.12173	2.185148
3.90E-02	43.17321	45.0151	2.231646
5.53E-02	42.89313	44.9237	3.347465
5.53E-02	42.82426	45.00494	3.347465
0.0553919	42.90231	45.03033	3.27774
7.65E-02	42.56713	45.04556	4.184336
7.66E-02	42.61304	44.9237	4.323822
0.1076396	42.56713	45.21312	5.43958
0.1077162	42.55795	45.15727	5.579051
0.150165	42.69569	45.27913	6.764551
0.1501747	42.56713	45.2182	7.008625
0.2105342	42.87017	45.27405	9.10062
0.2107553	42.90231	45.45684	9.10062
0.295711	43.13648	45.47208	12.0642
0.2958682	43.19158	45.58886	12.13392
0.4148294	45.57001	46.9801	15.69003
0.4148972	43.37066	45.75134	15.48082
0.4150179	43.47167	45.88843	15.48083
0.58038	43.43034	45.34006	19.81921
0.5804449	43.5084	45.40607	19.91993
0.8127472	43.19617	45.07603	25.52067
0.8128158	43.20995	44.89832	25.17207
0.812861	43.1824	45.11665	24.33547
1.13658	43.1273	44.96432	31.93423
1.136776	43.09975	44.92878	31.69025
1.137023	43.14108	44.89832	31.69025
1.590384	43.20995	44.87293	39.49726
1.591019	43.20076	44.72568	39.63666
2.23136	43.29719	44.92878	48.20939
2.232051	43.33851	44.97448	48.34878
3.121243	43.66451	45.2639	55.63127
slope=0.764			
5.46E-02	62.2007	65.76184	2.770033

EHD Data for Idemitsu Kosan FVC68B Under R-134a Pressure (~50 wt%)
(T=22.0 ± 0.2°C, P=5.84 bars; T=45°C, P=10.12 bars; T=65°C, P=14.81 bars)

0.0767988	59.93246	64.05579	3.441871	
7.69E-02	59.87277	64.04057	3.482755	
0.1076307	59.64319	64.14719	4.507955	
0.1076498	59.6891	64.17766	4.350331	
0.1502061	62.24202	65.51812	5.43958	
0.1502776	62.38895	65.62475	5.021181	
0.2103084	62.2512	65.2287	6.590199	
0.2105948	62.28793	65.20839	6.48559	
0.2106671	62.37976	65.51305	6.555346	
0.2106766	62.07672	65.2744	6.69481	
0.2955863	62.22365	64.8225	9.763095	
0.2956543	61.89765	64.21828	9.763095	
0.2958176	61.77827	64.92405	8.996013	
0.2962951	61.73235	64.84281	8.996013	
0.4147393	61.83337	66.08173	12.90096	
0.4148754	61.6497	64.06087	13.13339	
0.4149845	61.37421	63.67498	13.04041	
0.4153754	62.87106	64.8885	13.11012	
0.5803503	60.9977	64.67017	15.16708	
0.5806521	63.43583	65.69076	16.213	
0.5809515	63.51389	65.62475	16.213	
0.8137467	63.68836	66.27975	20.05936	
0.8139455	63.62408	66.06142	19.94316	
1.138399	63.70214	66.493	25.10236	
1.138961	63.73887	66.68595	24.89323	
1.590333	61.25024	64.89359	29.63377	
1.590384	61.40635	65.20839	29.70348	
2.229587	60.92883	64.462	36.53489	
2.230567	61.0528	64.63971	36.39547	
3.116803	60.91046	64.40614	42.87768	
3.119115	60.91965	64.26397	43.1913	
3.119233	60.92424	64.45184	43.19131	
slope=0.704				

EHD Data for ICI Emkarate RL32H Under R-410A Pressure (~10 wt%)
(T=22.5 ± 0.7°C, P=6.19 bars; T=45°C, P=8.60 bars; T=65°C, P=10.67 bars)

Software version	2		
Lubricant name	ICI Emkarate RL32H		
Viscosity	0		
Oil refractive index	1.437		
Spacer type	Silica		
Ball diameter	0.01905		
Disc track radius	0.04212		
Trigger point	506		
Comments	ICI RL32H under R-410A pressure 6/3/98		
Temperature=Ambie	45	65°C Load=20N	
M.R.=0.140 Trig. Pt.=506			
Avg. Band Top=237 Bottom=290			
Spacer Layer Film Thickness=482.0			
R.I.25°C=1.4510 45°C=1.4440 65°C=1.4370			
Disc #395			
Number of logged da	122		
Disc Speed (m/s)	Pot Temp (°C)	Lube Temp (°C)	Film (nm)
1.04E-02	23.58557	22.27289	7.36558
1.51E-02	23.59934	22.34905	9.86214
1.51E-02	23.58557	22.76033	9.62451
1.96E-02	23.5672	22.2932	12.48714
2.74E-02	23.58557	22.29828	14.6722
2.74E-02	23.58097	22.30843	14.77626
2.75E-02	23.59475	22.30843	14.6722
3.97E-02	23.59934	22.37952	19.35416
3.97E-02	23.60852	22.36429	19.21546
3.98E-02	23.59934	22.34905	19.14603
4.00E-02	23.57638	22.36936	19.14603
5.53E-02	23.60393	22.40491	22.47531
5.53E-02	23.60393	22.39983	22.47531
7.67E-02	23.60393	22.64863	26.22052
7.68E-02	23.60393	22.65371	26.74066
7.70E-02	23.60393	22.63847	26.74066
0.1078611	23.58557	22.76033	33.08609
0.1079317	23.57638	22.76541	33.01681
0.1080516	23.58097	22.73495	33.29417
0.1503367	23.57179	22.77049	40.36704
0.151099	23.58557	22.76033	40.02039
0.2109715	23.55342	22.80603	51.18317
0.2114066	23.57638	22.82126	51.25248
0.294427	23.5672	22.85173	63.86897
0.2945284	23.56261	22.85681	63.79966
0.4137471	23.21824	21.97332	85.54156
0.4137565	23.20906	21.93777	85.2644
0.4137666	23.21365	21.95301	85.54156
0.4140409	23.59475	22.3846	81.64589
0.414187	23.59934	22.42014	81.2301
0.5774996	23.19987	21.95809	107.9195
0.577732	23.22283	21.96316	107.7116
0.809578	23.2412	22.05964	134.3111
0.8098116	23.22742	22.05964	134.3111
1.133764	23.26875	22.15103	179.9822
1.134074	23.25956	22.12564	180.1245

EHD Data for ICI Emkarate RL32H Under R-410A Pressure (~10 wt%)
(T=22.5 ± 0.7°C, P=6.19 bars; T=45°C, P=8.60 bars; T=65°C, P=10.67 bars)

1.586042	23.31007	22.50646	219.7782
1.587635	23.30089	22.40998	220.0153
2.222453	23.37435	22.47091	264.1078
2.223613	23.35599	22.41506	264.5819
3.107734	23.53047	22.98374	319.5501
3.110105	23.42486	22.78064	310.9333
3.110452	23.5121	22.9025	320.2726
3.110587	23.39731	22.6334	310.7438
slope=0.659			
0.0103621	43.58646	45.72087	3.650226
1.04E-02	43.40279	45.35022	3.754801
1.51E-02	41.42842	44.75615	4.451908
1.51E-02	41.42383	44.94909	4.451908
1.97E-02	44.53232	45.79196	5.42786
1.97E-02	44.83996	46.37587	5.21875
2.73E-02	43.59564	44.8577	6.682662
2.74E-02	43.39724	44.92146	6.650424
3.96E-02	43.02991	44.82146	8.003155
3.99E-02	43.97482	44.84177	8.10724
3.99E-02	43.02073	44.84177	8.10724
5.52E-02	43.17685	45.11665	10.1883
0.0555297	43.84625	44.54797	10.1883
7.68E-02	44.67925	46.40126	12.58151
7.70E-02	44.66088	46.23878	12.89364
7.70E-02	44.6517	46.35556	12.58151
0.1080932	43.25127	44.80184	16.84745
0.1081408	44.06398	45.45177	16.43123
0.1511222	41.44219	44.61398	20.48888
0.1511919	41.42383	44.5632	20.80101
0.2112771	42.05746	45.29944	25.65594
0.2115099	43.06761	46.19816	26.00269
0.2115756	42.12634	45.49746	26.21078
0.2943995	43.37984	45.93921	34.32469
0.2944933	43.36147	45.94936	34.39402
0.2947388	43.04006	45.76657	35.09717
0.2948743	42.94823	45.75642	35.1665
0.4137076	42.58549	45.64979	45.49806
0.4138056	42.72324	45.74626	45.22067
0.5780122	42.24572	45.30959	57.83828
0.5780806	42.08042	45.11665	57.63036
0.8096926	42.53808	44.65967	75.85938
0.8099298	42.4984	44.77645	75.37429
1.134673	42.66563	44.81087	92.66319
1.134704	42.682329	44.89212	92.55927
1.587899	42.43856	44.81553	116.8224
1.588665	42.33755	44.58859	117.1688
2.224831	42.90691	45.24359	144.8681
2.225629	42.81507	45.14204	145.6643
3.11208	43.32014	46.00014	185.472
3.113936	43.30637	45.90874	185.472

EHD Data for ICI Emkarate RL32H Under R-410A Pressure (~10 wt%)
(T=22.5 ± 0.7°C, P=6.19 bars; T=45°C, P=8.60 bars; T=65°C, P=10.67 bars)

slope=0.705			
1.97E-02	60.50714	64.83211	2.732095
1.98E-02	60.39695	64.83719	2.732095
2.74E-02	60.81863	65.92432	3.993037
2.76E-02	60.74976	65.7263	3.993037
3.99E-02	60.85077	65.74153	5.043738
3.99E-02	60.52477	65.60444	5.043738
3.99E-02	60.85536	65.73645	5.043738
5.53E-02	59.67992	64.39091	6.304732
5.53E-02	59.51463	64.96467	5.779353
5.55E-02	59.82226	65.04083	5.954479
7.71E-02	59.52381	65.00529	7.460454
7.72E-02	59.5835	64.85297	7.145306
0.1079497	59.59268	65.26933	10.40246
0.108209	59.51463	65.28455	10.71764
0.1082544	59.59727	65.27948	9.666958
0.1506416	59.79471	65.46227	11.76827
0.1514367	59.52381	65.10684	12.39874
0.1514902	59.60646	65.02052	11.66323
0.2121008	59.62023	65.13731	16.39107
0.2121008	59.53758	65.14746	16.39107
0.2122432	59.74879	65.28963	16.39107
0.2952279	59.5835	64.95959	22.48418
0.2953077	59.60646	64.95959	22.55419
0.414646	59.97378	66.12743	28.88213
0.4148375	59.84063	66.04618	28.88212
0.578959	58.78915	64.75141	37.87994
0.579452	58.98659	65.03068	37.80992
0.8110161	59.73961	64.94436	50.34193
0.8113779	59.91868	65.1627	50.24857
0.8119257	59.56417	65.23351	49.64188
0.8119648	59.48152	65.06087	49.85187
1.136502	60.13449	65.66029	63.01159
1.136879	60.16663	65.90401	62.69664
1.590249	60.27682	66.09188	78.15144
1.590801	60.21254	66.18327	78.1981
2.227925	59.53299	64.96975	95.4375
2.228074	59.64778	65.17285	95.22758
3.117302	59.39065	64.43153	118.1704
3.11776	59.34473	64.45692	117.9606
slope=0.753			

EHD Data for ICI Emkarate RL32H Under R-410A Pressure (~20 wt%)
(T=23 ± 0.5°C, P=10.46 bars; T=45°C, P=15.57 bars)

Software version	2		
Lubricant name	ICI Emkarate RL32H		
Viscosity	0		
Oil refractive index	1.444		
Spacer type	Silica		
Ball diameter	0.01905		
Disc track radius	0.04115		
Trigger point	131		
Comments	ICI RL32H under R-410A pressure 6/9/98		
Temperature=Ambi	45°C Load=20N		
M.R.=0.134 Trig. Pt.=131			
Avg. Band Top=234 Bottom=280			
Spacer Layer Film Thickness=455.3			
R.I.25°C=1.4510 45°C=1.4440 65°C=1.4370			
Disc #400			
Number of logged d	82		
Disc Speed (m/s)	Pot Temp (°C)	Lube Temp (°C)	Film (nm)
1.02E-02	24.0034	22.78572	2.371002
1.02E-02	24.00799	22.72479	2.371002
1.48E-02	23.99881	22.81111	2.856373
1.48E-02	24.0034	22.7451	2.856373
1.49E-02	23.99422	22.62832	2.856373
2.08E-02	24.05391	22.51154	3.37643
2.09E-02	24.03554	22.82634	3.480452
2.83E-02	24.05391	22.60801	4.312419
2.84E-02	24.04013	22.85173	4.520472
3.91E-02	24.04931	22.82634	5.56054
3.92E-02	24.04472	22.83142	4.867158
3.92E-02	24.03554	22.82126	4.936504
5.58E-02	24.00799	22.72987	7.224616
5.58E-02	24.02636	22.72479	6.762364
5.58E-02	23.98044	22.86696	7.016556
5.60E-02	24.01258	22.86188	6.808592
0.0560322	24.03554	22.82634	7.016556
7.68E-02	24.03095	22.78572	8.680622
7.69E-02	24.02636	22.81619	8.888635
0.0770164	23.98503	22.86696	8.680612
0.1069533	24.13655	23.25793	12.68332
0.1073293	24.13655	23.34425	12.68332
0.1504688	24.04013	23.39502	16.08042
0.1508964	24.05391	23.36964	15.17918
0.1509361	24.13196	23.43564	16.08042
0.1509384	24.15033	23.40518	16.21908
0.2107998	24.09523	23.49657	20.65589
0.2112808	24.09982	23.45088	20.17064
0.2113968	24.12737	23.47626	19.82399
0.2953102	24.06768	23.49657	28.905
0.295518	24.04013	23.49657	28.83567
0.4131743	23.81514	22.61308	36.29198
0.4133581	23.81055	22.5877	36.32663
0.4171225	24.01717	22.82126	37.63836
0.417132	23.86565	22.75526	37.32644
0.5832289	24.06309	22.87204	46.3013
0.5833433	24.0585	22.7908	46.23202
0.8088418	23.84269	22.77557	56.14627
0.8090318	23.85647	22.79588	56.07697

EHD Data for ICI Emkarate RL32H Under R-410A Pressure (~20 wt%)
(T=23 ± 0.5°C, P=10.46 bars; T=45°C, P=15.57 bars)

1.130768	23.87943	22.88219	68.98873
1.130846	23.8932	22.91266	68.87328
1.583913	23.90238	23.01421	85.47458
1.585563	23.90697	23.00406	85.47458
2.221187	23.93452	23.197	107.911
2.221338	23.97585	23.28332	107.7033
3.106179	23.97585	23.38995	128.8173
3.107272	24.0585	23.42549	128.5405
slope=0.742			
0.0389218	43.31096	45.94936	3.757255
3.90E-02	43.46249	46.0306	3.548227
5.48E-02	43.86654	46.34033	5.011433
5.56E-02	43.99511	45.63456	4.802355
5.57E-02	43.90327	46.02045	5.011382
7.50E-02	43.71961	45.87828	6.474554
7.51E-02	43.8344	45.8732	6.683571
0.1045319	43.03547	45.28928	8.773697
0.1052373	42.95282	45.19789	9.191706
0.1056126	42.97119	45.30452	8.66918
0.1497993	42.9115	45.26897	11.76941
0.1500326	42.9115	45.13696	11.69976
0.2110848	42.88395	45.27405	15.87973
0.2110896	42.87936	45.29436	15.67074
0.2112769	42.90691	45.23851	15.18308
0.2957715	42.83803	45.19281	20.47743
0.2959165	42.87936	45.22328	20.68641
0.413294	42.30082	44.38549	26.74656
0.4134602	42.2044	44.30932	26.74656
0.4137462	42.84262	45.24866	25.84105
0.5782669	42.30541	44.25347	33.50273
0.5783396	42.25949	44.20778	33.36343
0.5785961	42.83803	45.20297	32.49287
0.8093481	43.00792	44.94401	41.4422
0.8094704	43.14108	45.06587	41.4422
1.131498	43.32474	45.467	51.29561
1.131511	43.42575	45.63963	51.19117
1.585524	43.6737	46.19816	62.26164
1.585857	43.54513	45.9646	62.67936
2.220863	42.5809	44.84754	76.86477
2.221473	42.50744	44.82723	76.86475
2.222052	42.60845	44.95925	76.60175
2.223166	42.60845	45.12173	76.53213
3.107549	42.66814	44.92878	95.3075
3.108269	42.59468	44.84754	95.44668
slope=0.740			

EHD Data for ICI Emkarate RL32H Under R-410A Pressure (~20 wt%)
(T=65°C, P=19.84 bars)

Software version	2		
Lubricant name	ICI Emkarate RL32H		
Viscosity	0		
Oil refractive index	1.437		
Spacer type	Silica		
Ball diameter	0.01905		
Disc track radius	0.0427		
Trigger point	394		
Comments	ICI RL32H under R-410A pressure 7/14/98		
Temperature=65°C Load=20N			
M.R.=0.140 Trig. Pt.=394			
Avg. Band Top=237 Bottom=287			
Spacer Layer Film Thickness=457.9			
R.I.65°C=1.4370			
Disc #408			
Number of logged d:	37		
Disc Speed (m/s)	Pot Temp (°C)	Lube Temp (°C)	Film (nm)
5.46E-02	59.02792	65.15735	3.889106
5.46E-02	58.62845	65.05072	4.20444
5.46E-02	58.56876	65.01517	4.20444
5.46E-02	59.07843	65.03548	3.854067
7.65E-02	57.15456	64.74607	4.940183
7.66E-02	57.25098	64.72576	5.185434
7.66E-02	57.00763	64.79684	5.535779
7.66E-02	57.14996	64.7156	5.045323
7.66E-02	57.25098	64.69529	5.185434
0.1079078	57.23261	64.86312	6.867149
0.1079543	56.801	64.55735	6.727006
0.1080753	57.0214	64.62447	6.937219
0.1082159	56.93875	64.82335	6.937219
0.1502997	57.57239	64.90882	9.459717
0.1504735	57.45301	64.70572	9.529781
0.1505216	57.84329	65.05099	9.459717
0.2113799	59.80389	66.56917	12.75286
0.2115663	58.18766	65.24393	12.47256
0.211594	59.73043	66.52347	12.40258
0.2959738	59.5835	66.28483	15.69555
0.2960976	59.67992	66.29498	15.83567
0.4133419	59.4733	66.11219	20.17944
0.4134687	59.45493	66.21882	20.24951
0.5783957	59.34933	65.99541	26.41442
0.5786273	59.35392	66.1782	26.41442
0.8086496	59.53299	66.14774	33.97979
0.8087466	58.71569	64.9342	34.57522
0.8090544	58.50907	64.79711	34.47014
1.133286	59.2529	65.73138	42.98015
1.133839	59.29423	65.80754	42.84008
1.586964	59.37688	65.89386	52.32952
1.587822	59.3631	65.77708	52.22448
2.232855	60.15744	65.53336	64.09322
2.233758	60.18499	65.6806	64.09322
2.234594	60.21714	65.70599	64.09322

EHD Data for ICI Emkarate RL32H Under R-410A Pressure (~20 wt%)
(T=65°C, P=19.84 bars)

3.120403	60.60283	66.33052	75.11983
3.121666	60.58446	66.33052	75.11983
slope=0.748			

EHD Data for ICI Emkarate RL68H Under R-410A Pressure (~10 wt%)
(T=23.0 ± 0.5°C, P=5.22 bars; T=45°C, P=7.50 bars; T=65°C, P=9.63 bars)

Software version	2		
Lubricant name	ICI Emkarate RL68		
Viscosity	0		
Oil refractive index	1.441		
Spacer type	Silica		
Ball diameter	0.01905		
Disc track radius	0.0415		
Trigger point	138		
Comments	ICI RL68H under R-410A pressure 6/12/98		
Temperature=Ambi	45 65°C Load=20N		
M.R.=0.138 Trig. Pt.=138			
Avg. Band Top=234 Bottom=287			
Spacer Layer Film Thickness=463.3			
R.I.25°C=1.4536 45°C=1.4468 65°C=1.4406			
Disc #400			
Number of logged c	128		
Disc Speed (m/s)	Pot Temp (°C)	Lube Temp (°C)	Film (nm)
1.02E-02	24.33399	23.17669	11.7165
1.03E-02	24.3294	23.16653	11.7165
1.04E-02	24.35695	23.15638	11.7165
1.49E-02	24.35236	23.20716	15.44964
1.49E-02	24.33399	23.19192	16.0718
1.50E-02	24.3294	23.18177	15.44964
1.94E-02	24.36154	23.15638	19.90846
1.94E-02	24.37531	23.12592	19.73563
2.84E-02	24.36613	23.21223	24.47062
2.86E-02	24.3294	23.21731	24.57433
2.87E-02	24.35695	23.22746	24.83307
3.92E-02	24.36613	23.22746	30.74198
0.0392787	24.35695	23.22746	30.63833
5.45E-02	24.34777	23.30363	37.53101
5.46E-02	24.34317	23.27824	37.46192
5.46E-02	24.37991	23.29347	37.53101
7.72E-02	24.37531	23.42549	47.37585
7.73E-02	24.36154	23.46611	47.37585
0.1078341	24.35695	23.1056	56.49641
0.1081289	24.36613	23.11068	56.28915
0.150478	24.33399	23.09037	71.41827
0.1504823	24.33399	23.10053	71.41824
0.1505274	24.34777	23.1056	71.211
0.2112721	24.35695	23.09545	91.27442
0.2113571	24.34317	23.12084	91.46432
0.2951802	24.33858	23.09545	112.2293
0.2952892	24.35236	23.09037	111.608
0.2954169	24.34317	23.11068	111.7115
0.4124471	23.91157	22.72987	150.0232
0.4124859	23.92993	22.7451	150.0705
0.5783289	23.94371	22.78064	187.3294
0.5786834	23.92075	22.71464	187.5185
0.8085738	23.94371	22.7908	231.1915
0.8087066	23.93912	22.80603	231.1915

EHD Data for ICI Emkarate RL68H Under R-410A Pressure (~10 wt%)
(T=23.0 ± 0.5°C, P=5.22 bars; T=45°C, P=7.50 bars; T=65°C, P=9.63 bars)

1.131651	23.99881	23.0396	280.5233
1.132411	23.95748	23.00913	280.9012
1.584068	24.09982	23.42041	346.8795
1.584358	24.09523	23.46611	346.8395
1.58506	24.06768	23.28332	347.5394
1.585161	24.07227	23.25793	346.8795
2.219266	24.109	23.51181	413.3326
2.219348	24.1641	23.59812	412.3732
2.22063	24.15033	23.50673	413.9322
3.106663	24.37991	23.26809	477.8298
3.108508	24.34777	23.27316	477.1754
3.10871	24.32022	23.197	477.6117
slope=0.656			
1.03E-02	43.02629	45.00494	6.470126
1.03E-02	43.25127	45.08619	6.330988
1.04E-02	43.15485	44.94909	6.261419
1.48E-02	42.84262	44.98463	8.348495
1.48E-02	42.87017	44.71553	8.835466
0.0148579	42.79211	44.85262	8.870248
0.0192863	44.38539	45.20297	9.809401
1.94E-02	44.22928	45.08619	10.43547
1.95E-02	43.65533	44.69014	9.600677
0.0195295	43.79767	44.80692	9.600677
2.86E-02	43.46249	45.43653	13.28757
0.0286239	43.0722	44.69521	13.00935
3.92E-02	44.06398	45.7818	17.58166
3.93E-02	44.13745	45.75134	17.58166
5.45E-02	44.27519	46.05091	21.19871
5.48E-02	44.30733	46.10169	21.19871
7.73E-02	44.2706	45.75134	25.82398
7.74E-02	44.3257	45.88843	25.92829
0.107461	40.79937	44.89297	31.71698
0.10784	40.87284	44.82696	31.5431
0.1503772	42.0345	45.45684	39.67934
0.1509177	41.77738	45.18773	40.47898
0.2106182	42.80589	45.97983	48.92722
0.2112247	43.03547	46.11184	48.9274
0.2116297	42.84262	46.00521	49.1357
0.2117939	43.29259	46.15246	49.97033
0.294854	43.59105	46.17785	62.69267
0.2948965	43.50381	46.17277	62.76217
0.4125498	42.7462	44.96432	80.65722
0.4125974	42.74161	44.9694	80.6572
0.5785988	42.75998	44.87801	101.086
0.5787032	42.73701	44.90847	101.086
0.8092411	42.87017	45.00494	124.3408
0.8096295	42.86558	45.00494	124.2714
1.132215	43.05383	45.25374	161.8023
1.132286	43.05843	45.20297	161.8023

EHD Data for ICI Emkarate RL68H Under R-410A Pressure (~10 wt%)
(T=23.0 ± 0.5°C, P=5.22 bars; T=45°C, P=7.50 bars; T=65°C, P=9.63 bars)

1.585703	43.13189	45.47715	198.3383
1.586405	43.11812	45.43653	198.6238
2.221252	43.15944	45.5787	238.7605
2.222078	43.24668	45.49746	237.9997
3.106211	43.40739	45.73103	282.7771
3.106249	43.41198	45.87828	282.492
slope=0.670			
1.03E-02	60.76353	66.11726	4.290981
1.04E-02	60.69466	66.13758	4.290981
1.49E-02	61.22728	65.67552	5.757044
1.50E-02	61.20432	65.61967	5.652327
1.51E-02	61.18137	65.45211	5.652327
0.0195295	60.00133	64.58385	6.432464
1.96E-02	60.72221	64.80219	6.560747
2.85E-02	59.04628	64.59745	8.78324
2.87E-02	61.49359	65.61967	8.526725
3.94E-02	60.39161	65.31502	10.29456
5.46E-02	59.82685	64.59641	13.29631
5.47E-02	59.87736	64.55735	13.71506
5.47E-02	59.87736	64.58979	14.48292
5.48E-02	59.92786	64.44169	13.50565
7.73E-02	60.74057	65.72122	16.01855
7.76E-02	60.70384	65.67045	15.87894
0.1080512	59.8544	64.25381	20.13671
0.1085155	60.90128	65.30486	19.78776
0.1088156	60.92424	65.3201	19.78776
0.1506201	59.17485	65.35056	24.60371
0.1508074	58.59631	64.9342	23.87086
0.1510137	59.19781	65.38103	24.39432
0.2110892	60.40998	64.86312	30.04743
0.2116299	60.19877	65.83292	30.67545
0.29551	61.35585	66.07664	40.20091
0.2958893	61.29156	66.14265	40.20091
0.4132969	58.51366	64.96467	52.23676
0.4133538	58.23357	64.5737	52.65534
0.5792552	60.38243	64.59401	66.15375
0.5795698	60.19418	64.89951	66.60714
0.8098598	60.87373	65.35056	82.47385
0.8101172	60.70384	65.01037	82.99685
1.133448	59.67992	65.22363	101.6491
1.133543	59.54676	64.89359	102.0674
1.586733	59.28505	64.58385	125.2788
1.587214	59.37688	64.87568	125.4879
2.22171	59.57431	64.83859	163.7006
2.222424	59.54676	64.89289	163.9871
3.107958	59.98296	64.69048	195.924
3.110915	59.88654	64.51277	196.2582
slope=0.672			

EHD Data for ICI Emkarate RL68H Under R-410A Pressure (~15 wt%)
(T=23.6 ± 0.5°C, P=7.43 bars; T=45°C, P=11.01 bars; T=65°C, P=14.12 bars)

Software version	2		
Lubricant name	ICI Emkarate RL68H		
Viscosity	0		
Oil refractive index	1.441		
Spacer type	Silica		
Ball diameter	0.01905		
Disc track radius	0.04235		
Trigger point	93		
Comments	ICI RL68H under R-410A pressure 6/13/98		
Temperature=Ambi	45 65°C Load=20N		
M.R.=0.140 Trig. Pt.=93			
Avg. Band Top=234 Bottom=283			
Spacer Layer Film Thickness=459.1			
R.I.25°C=1.4536 45°C=1.4468 65°C=1.4406			
Disc #400			
Number of logged d	113		
Disc Speed (m/s)	Pot Temp (°C)	Lube Temp (°C)	Film (nm)
1.05E-02	24.44419	23.21731	7.057861
1.05E-02	24.47633	23.30363	7.057861
1.06E-02	24.46715	23.28332	7.57643
0.0105694	24.44878	23.23762	7.403558
1.37E-02	24.48092	23.31378	9.546885
1.37E-02	24.48092	23.31378	9.339467
1.97E-02	24.50388	23.33409	11.62108
1.97E-02	24.50388	23.34425	11.41367
0.0276226	24.56816	23.42549	15.147
0.0277335	24.55439	23.40518	15.04327
3.85E-02	24.53143	23.46103	18.46542
3.86E-02	24.51765	23.45088	18.46542
5.58E-02	24.60949	23.50165	22.92422
5.58E-02	24.64622	23.45595	23.37356
7.72E-02	24.67377	23.73014	29.29967
7.73E-02	24.70132	23.78599	28.67756
7.74E-02	24.67377	23.78091	29.29966
0.1067629	24.68754	23.78599	34.89835
0.107051	24.69673	23.78091	35.24386
0.1504353	24.62785	24.00433	42.41306
0.1506559	24.63704	23.92309	43.03505
0.1506613	24.64622	23.98909	42.6204
0.2100003	24.6003	24.0094	53.46953
0.2106579	24.62785	23.92816	53.81511
0.2946022	24.58194	24.10588	71.70898
0.2946781	24.59112	24.09064	71.6399
0.4129144	24.29267	23.03452	94.46938
0.4129479	24.27889	23.04467	94.79163
0.4131164	24.29726	23.02436	94.5154
0.5774966	24.32022	23.04467	116.7132
0.5780518	24.29726	23.08022	116.7132
0.5780604	24.3294	23.07006	116.5061
0.8099203	24.30644	23.15638	146.3912
0.8100445	24.30644	23.17669	146.1842
1.131499	24.38909	23.3544	192.825
1.132098	24.37072	23.29855	192.9196

EHD Data for ICI Emkarate RL68H Under R-410A Pressure (~15 wt%)
(T=23.6 ± 0.5°C, P=7.43 bars; T=45°C, P=11.01 bars; T=65°C, P=14.12 bars)

1.584171	24.39827	23.53719	235.7414
1.585539	24.3845	23.47119	235.9304
2.218844	24.48551	23.82661	279.7246
2.219231	24.4396	23.70475	280.9999
2.220434	24.43501	23.78599	280.1025
2.220647	24.39827	23.83169	280.1025
3.105024	24.52684	24.03987	333.9762
3.10642	24.52225	24.1008	333.7963
3.10784	24.56816	24.11603	333.6163
slope=0.679			
1.37E-02	43.5635	45.72087	4.890712
1.98E-02	43.69206	45.35022	5.965031
2.00E-02	43.56809	45.33498	5.861302
2.77E-02	43.30637	44.82723	8.039212
2.77E-02	43.21454	44.59367	7.90096
3.86E-02	43.05383	45.23851	10.21716
3.86E-02	43.0722	45.43653	10.94315
0.0557542	44.11908	45.98491	13.93447
5.58E-02	44.05021	46.04076	13.62338
7.75E-02	44.13285	45.66502	17.21589
7.75E-02	43.48544	45.27405	17.0085
0.1071594	42.84262	45.60917	21.84765
0.1071651	43.28341	45.76149	21.36375
0.1072952	43.24668	45.78688	20.32681
0.1502378	43.00333	46.14738	25.71873
0.1505958	42.78293	45.91382	26.34088
0.1507542	42.92527	45.96967	25.78787
0.2113806	42.99874	46.24386	32.35445
0.2116059	43.11812	46.01537	32.35445
0.2120193	43.1273	46.18801	32.87286
0.2949466	43.24209	45.69041	42.30682
0.2950431	43.10893	45.52793	41.75393
0.2952866	43.06761	45.37053	42.92883
0.4137238	41.96563	44.64177	56.78622
0.4138542	42.44316	44.70115	56.83803
0.4139206	42.16307	44.70622	56.95895
0.5792143	41.80033	44.80932	69.42932
0.5792502	41.83707	44.83669	69.84384
0.811482	42.92068	44.80072	89.39097
0.8116407	42.66355	44.728901	89.32193
1.133747	44.12367	46.15006	108.134
1.134282	43.82522	45.88843	108.134
1.588407	42.68651	44.98971	132.3117
1.588676	42.70947	45.13188	132.0529
2.223619	42.73243	44.91355	177.5078
2.225503	42.69569	44.86277	177.3502
3.110245	42.88395	45.02018	212.6164
3.1126	42.91609	45.22328	211.9546
slope=0.702			

EHD Data for ICI Emkarate RL68H Under R-410A Pressure (~15 wt%)
(T=23.6 ± 0.5°C, P=7.43 bars; T=45°C, P=11.01 bars; T=65°C, P=14.12 bars)

2.77E-02	60.30637	65.82723	5.039212
2.77E-02	60.21454	65.59367	4.90096
3.86E-02	60.16204	65.67045	6.850422
5.57E-02	60.63497	65.13223	9.020691
5.58E-02	60.66711	65.12207	9.124406
0.0775456	60.42376	64.86312	10.68
7.76E-02	60.09776	64.91389	10.95657
0.1066995	60.0197	64.93929	13.27268
0.1073807	60.02429	64.94436	13.65292
0.1501094	60.06561	65.44196	17.93927
0.1506907	59.76257	65.39118	16.55657
0.15091	59.93246	65.36072	16.90226
0.1512677	59.92327	65.27948	17.45528
0.2112498	60.2355	65.35056	23.02026
0.21142	60.24009	65.36072	23.02026
0.2952888	60.37784	65.5892	30.17464
0.2954393	60.32733	65.62982	30.45113
0.4135108	60.39621	65.63998	38.5781
0.4137158	60.36406	65.52827	38.43985
0.5785546	60.70843	66.29498	49.1483
0.5785964	60.69466	66.08173	49.21741
0.8110917	59.22076	65.03576	59.51287
0.8113222	59.1473	64.81235	59.82378
1.133173	59.00955	64.44169	75.333
1.134497	59.01873	64.45692	75.26395
1.58715	59.07843	64.10149	97.69245
1.588286	59.06006	64.11672	97.53707
2.225518	59.39524	64.37568	115.9059
2.225571	59.50085	64.49754	115.8023
3.110705	59.91868	64.8885	143.5945
3.111098	60.08398	65.0256	143.3415
3.114441	59.69829	64.5737	142.5134
slope=0.712			

EHD Data for ICI Emkarate RL68H Under R-410A Pressure (~30 wt%)
(T=22.8 ± 0.5°C, P=13.15 bars; T=45°C, P=18.05 bars)

Software version	2		
Lubricant name	ICI Emkarate RL68H		
Viscosity	0		
Oil refractive index	1.454		
Spacer type	Silica		
Ball diameter	0.01905		
Disc track radius	0.0448		
Trigger point	206		
Comments	ICI RL68H under R-410A pressure 6/19/98		
Temperature=Ambient			
M.R.=0.136 Trig. Pt.=206			
Avg. Band Top=237 Bottom=287			
Spacer Layer Film Thickness=446.5			
R.I.25°C=1.4536			
Disc #400			
Number of logged c	43		
Disc Speed (m/s)	Pot Temp (°C)	Lube Temp (°C)	Film (nm)
1.45E-02	23.82892	22.81619	2.698909
1.45E-02	23.85647	22.72479	2.491317
1.93E-02	23.85188	22.55723	3.321756
1.93E-02	23.81514	22.77557	3.529347
2.76E-02	23.86106	22.86188	4.048345
2.76E-02	23.82433	22.88727	3.944555
2.77E-02	23.86106	22.64863	4.498151
2.77E-02	23.76464	22.44553	4.428955
3.91E-02	23.8932	22.92281	5.190175
3.92E-02	23.88861	22.89743	5.60535
3.92E-02	23.81055	22.84157	5.674535
5.56E-02	23.81973	22.88727	7.058533
5.58E-02	23.87483	22.89235	6.850941
5.58E-02	23.87943	22.91774	7.266129
7.71E-02	23.88861	23.04975	8.407917
7.72E-02	23.87483	23.00406	8.096509
7.73E-02	23.81055	22.9939	8.373321
0.1085783	23.82892	23.08022	10.86438
0.1086603	23.84269	23.08529	10.17241
0.1088179	23.87943	23.05991	10.79518
0.1511449	23.85647	22.88727	12.45588
0.1513827	23.87483	23.05991	12.59424
0.1513981	23.87943	23.13099	12.38668
0.1514693	23.85647	23.11068	12.55966
0.2101758	23.8381	23.12592	17.02256
0.2104174	23.84269	23.21731	16.60749
0.2968477	23.81055	23.00406	22.62687
0.29688	23.80596	23.2427	22.00423
0.4129319	23.19528	22.44045	27.40063
0.4130644	23.30548	22.43537	27.40063
0.5795469	23.35139	22.44553	34.80279
0.5797232	23.35139	22.42522	34.87198
0.8103288	23.37435	22.47599	44.10632
0.8105371	23.35139	22.47091	44.05443
1.133086	23.38813	22.56231	55.82918

EHD Data for ICI Emkarate RL68H Under R-410A Pressure (~30 wt%)
(T=22.8 ± 0.5°C, P=13.15 bars; T=45°C, P=18.05 bars)

1.133209	23.37435	22.50138	55.76002
1.587485	23.457	22.70956	69.45469
1.587898	23.43863	22.66894	69.59297
2.223637	23.52588	23.02944	85.14805
2.224916	23.42945	22.87204	85.28628
3.111351	23.69117	23.22239	105.3758
3.111677	23.66362	23.20716	105.6753
3.11324	23.64526	23.22746	105.5371
slope=0.688			

EHD Data for ICI Emkarate RL68H Under R-410A Pressure (~30 wt%)
(T=22.8 ± 0.5°C, P=13.15 bars; T=45°C, P=18.05 bars)

Software version	2		
Lubricant name	ICI Emkarate RL68H		
Viscosity	0		
Oil refractive index	1.435		
Spacer type	Silica		
Ball diameter	0.01905		
Disc track radius	0.04393		
Trigger point	473		
Comments	ICI RL68H under R-410a pressure 7/15/98		
Temperature=Amb	45 65°C Load=20N		
M.R.=0.135 Trig. Pt.=473			
Avg. Band Top=237 Bottom=290			
Spacer Layer Film Thickness=447.6			
R.I.25°C=1.4420 45°C=1.4350 65°C=1.4261			
Disc #408			
2.86E-02	42.21817	45.28421	2.727068
2.87E-02	42.26408	44.91862	2.621808
4.00E-02	42.62682	45.74118	3.428842
4.00E-02	42.72783	45.78688	3.358655
4.01E-02	42.92527	45.80719	3.148164
5.46E-02	42.92986	45.5787	4.270984
5.46E-02	42.47989	45.66502	4.621893
5.46E-02	42.90231	45.60409	4.411337
7.71E-02	42.70028	45.5127	5.814898
7.71E-02	42.78753	45.46192	6.025429
7.72E-02	42.63141	45.4213	5.885063
7.73E-02	42.61763	45.36545	5.885063
0.1075914	42.36969	45.32991	8.832411
0.1078594	42.56713	45.34006	8.762256
0.1080281	42.53499	45.34006	8.832411
0.1513302	42.39724	45.31467	10.93766
0.151454	42.45234	45.30959	11.00783
0.2111177	42.52121	45.25374	14.72693
0.2112343	42.49825	45.34514	14.72692
0.2950598	42.50744	45.20805	19.35802
0.2950642	42.45234	45.23343	19.07735
0.4143729	42.49825	45.29944	25.25183
0.414486	42.51203	45.18266	25.60258
0.5791697	42.47989	45.13696	33.98645
0.5791944	42.4202	45.08619	33.98637
0.8091708	42.92068	45.87828	43.63192
0.8093674	43.03088	45.98491	43.56177
1.134106	42.54876	45.70564	56.60746
1.134225	42.46611	45.54316	56.60746
1.588799	42.27327	45.1725	71.05312
1.588823	42.21358	45.04049	71.05312
2.224107	42.13552	44.80692	89.77185
2.224331	42.16307	44.89832	89.84193
3.11185	42.22735	44.69521	113.1061
3.112988	42.10338	44.65967	112.9309
3.11408	42.1493	44.63936	112.8609

EHD Data for ICI Emkarate RL68H Under R-410A Pressure (~30 wt%)
(T=22.8 ± 0.5°C, P=13.15 bars; T=45°C, P=18.05 bars)

slope=0.815			
-------------	--	--	--

EHD Data for Idemitsu Kosan FVC32B Under R-410A Pressure (~10 wt%)
(T=23.8 ± 0.5°C, P=6.05 bars; T=45°C, P=8.81 bars; T=65°C, P=11.15 bars)

Software version	2		
Lubricant name	Idemitsu Kosan FVC32		
Viscosity	0		
Oil refractive index	1.426		
Spacer type	Silica		
Ball diameter	0.01905		
Disc track radius	0.04135		
Trigger point	411		
Comments	Idemitsu Kosan FVC32B under R-410A pressure		
7/2/98 Temperature	45	65°C Load=20N	
M.R.=0.140 Trig. Pt.=411			
Avg. Band Top=234 Bottom=283			
Spacer Layer Film Thickness=469.2			
R.I.25°C=1.4394 45°C=1.4321 65°C=1.4256			
Disc #408			
Number of logged d	120		
Disc Speed (m/s)	Pot Temp (°C)	Lube Temp (°C)	Film (nm)
1.02E-02	24.61408	23.55243	7.880922
1.02E-02	24.64622	23.61336	7.985888
0.0102254	24.57275	23.62859	8.195773
1.02E-02	24.61408	23.53719	7.985873
1.47E-02	24.65999	23.65398	10.08478
1.48E-02	24.64163	23.58797	10.08478
2.07E-02	24.66918	23.77584	12.60326
2.07E-02	24.66918	23.67429	11.76374
2.07E-02	24.67377	23.67429	12.60324
2.84E-02	24.67377	23.82661	14.28223
2.85E-02	24.62785	23.83677	15.12171
3.89E-02	24.61408	23.86216	18.05979
3.90E-02	24.67836	23.77076	18.47948
3.93E-02	24.68754	23.83169	18.68932
5.42E-02	24.68754	23.92309	23.79236
5.45E-02	24.68754	23.96371	23.79236
7.70E-02	24.67377	23.90785	28.8285
7.70E-02	24.68295	23.92309	28.93337
0.1072316	24.69673	24.07541	37.56411
0.1073359	24.66918	24.06526	37.63407
0.1491746	24.68295	23.96371	43.22858
0.1492579	24.67377	24.0551	43.3684
0.1502282	24.67836	24.07541	43.22858
0.2102379	24.6554	24.16681	55.18507
0.2103669	24.67836	24.16681	55.60476
0.2934509	24.67836	24.14142	68.88733
0.2936019	24.66918	24.14142	69.09705
0.4120865	24.39368	23.35948	91.88116
0.4123069	24.40286	23.35948	91.67151
0.5772282	24.41205	23.37471	112.0032
0.5774097	24.42582	23.36456	111.9333
0.8093689	24.41664	23.4001	139.14
0.8094565	24.42582	23.43057	139.0003
1.132501	24.47174	23.51688	184.1626
1.132995	24.45796	23.54227	184.067

EHD Data for Idemitsu Kosan FVC32B Under R-410A Pressure (~10 wt%)
(T=23.8 ± 0.5°C, P=6.05 bars; T=45°C, P=8.81 bars; T=65°C, P=11.15 bars)

1.584822	24.48092	23.65398	227.4989
1.585793	24.51765	23.70475	227.212
2.220455	24.56816	23.84692	273.7473
2.220495	24.5452	23.76568	274.1616
3.106799	24.61867	23.96371	331.0992
3.107004	24.66459	24.21758	329.1563
3.107585	24.63244	24.08557	330.492
slope=0.661			
0.0101815	43.16403	45.06587	3.66265
1.03E-02	42.89772	44.9694	3.662663
1.04E-02	41.93808	44.82723	4.084522
0.0148688	42.0345	44.87801	4.928186
1.49E-02	42.34673	45.14204	5.114133
2.08E-02	43.06761	45.44161	6.478426
2.08E-02	42.82885	45.30452	6.163618
0.0284677	44.24305	45.83258	8.049211
2.87E-02	44.22009	45.97475	7.9948
3.92E-02	43.87114	44.37533	10.33831
3.93E-02	43.60023	44.3144	9.318925
5.45E-02	44.47722	45.49746	12.37707
5.46E-02	44.46345	45.40607	12.27163
7.71E-02	44.48182	45.83766	16.17321
7.72E-02	44.50477	45.81735	16.59496
7.73E-02	44.47263	45.84274	15.68113
0.1073234	43.19617	45.03541	19.52222
0.1077483	43.19617	45.01002	19.66213
0.1500138	42.93904	44.89324	24.34542
0.1502427	42.94364	44.95417	24.34542
0.2106126	42.76456	44.812	30.53545
0.2109047	42.84262	44.7663	31.54958
0.2942285	43.73798	45.88335	37.8111
0.2951495	43.67829	45.88335	38.09073
0.412542	43.45789	45.70564	47.67104
0.4125779	43.43953	45.65994	47.74098
0.5781149	43.44412	45.73103	61.93397
0.5785619	43.49004	45.75134	62.0388
0.8105009	43.54513	45.79704	77.80145
0.8109676	43.59105	45.92397	77.80145
1.133639	43.72879	46.0763	97.57812
1.134152	43.64615	45.98491	97.57812
1.588113	43.64156	46.00014	119.3051
1.589611	43.64156	45.91382	119.3051
2.22158	42.98037	45.03033	157.4633
2.222337	43.00333	45.04556	157.4633
2.223144	43.48544	45.6244	149.7208
2.224637	43.54972	45.72595	149.7208
3.109653	43.11812	45.08111	189.6166
3.110412	43.13189	45.18773	189.5209
slope=0.682			

EHD Data for Idemitsu Kosan FVC32B Under R-410A Pressure (~10 wt%)
(T=23.8 ± 0.5°C, P=6.05 bars; T=45°C, P=8.81 bars; T=65°C, P=11.15 bars)

2.10E-02	60.91046	66.00556	3.745359
2.85E-02	60.31815	65.29471	4.663241
2.86E-02	60.18499	65.22363	4.910346
3.92E-02	59.84063	64.45692	6.004644
3.93E-02	59.80848	64.45184	5.863436
5.44E-02	59.55136	64.57878	7.34612
5.44E-02	59.53758	64.59909	7.134315
7.71E-02	59.51003	64.75649	9.252258
7.76E-02	59.59727	64.8225	9.46408
7.76E-02	59.59268	64.74126	9.675864
0.107707	59.71206	64.93929	12.00557
0.1079221	59.61105	64.9799	12.00557
0.1498802	59.73961	65.17285	16.02946
0.1502827	59.80389	65.03576	15.5353
0.2109047	60.20795	65.44704	19.80275
0.2109117	60.24468	65.50288	19.69684
0.2113899	60.19418	65.45719	20.47333
0.2957755	60.52477	65.51812	26.19079
0.2962729	60.56609	65.52827	25.73197
0.4145589	60.35029	65.73645	35.4989
0.4146291	60.26305	65.6806	35.42863
0.58092	60.07479	65.42673	43.29935
0.5812972	60.00133	65.38103	43.08854
0.8146003	59.81308	65.1627	52.50411
0.8146544	59.70747	64.83773	52.78516
1.139764	59.49626	64.89599	66.83485
1.140173	59.5284	64.93859	66.76431
1.59554	59.63401	64.91828	85.52584
1.596429	59.69829	64.9675	85.87842
2.23439	60.12989	64.95451	102.2751
2.234409	60.24009	64.71587	102.5924
3.120493	60.74057	65.31502	122.4721
3.124507	60.60283	65.25916	122.6483
3.124966	60.68547	65.35056	122.4721
slope=0.709			

EHD Data for Idemitsu Kosan FVC32B Under R-410A Pressure (~20 wt%)
(T=23.4 ± 0.5°C, 9.70 bars; T=45°C, P=14.53 bars; T=65°C, P=19.84 bars)

Software version	2		
Lubricant name	Idemitsu Kosan FVC32		
Viscosity	0		
Oil refractive index	1.432		
Spacer type	Silica		
Ball diameter	0.01905		
Disc track radius	0.0417		
Trigger point	29		
Comments	Idemitsu Kosan FVC32B under R-410A pressure		
7/6/98 Temperature	45°C Load =20N		
M.R.=0.140 Trig. Pt.=29			
Avg. Band Top=237 Bottom=280			
Spacer Layer Film Thickness=470.9			
R.I.25°C=1.4394 45°C=1.4321			
Disc #408			
Number of logged d	84		
Disc Speed (m/s)	Pot Temp (°C)	Lube Temp (°C)	Film (nm)
1.02E-02	24.21002	23.1056	3.511495
1.02E-02	24.14115	23.13607	3.511477
1.03E-02	24.19625	23.01929	3.721364
1.49E-02	24.22379	23.03452	4.770808
1.50E-02	24.2192	23.11576	4.770808
1.50E-02	24.05391	23.12592	5.295524
1.94E-02	24.23298	23.18177	6.240067
1.96E-02	24.19625	23.12084	5.820284
2.87E-02	24.21002	23.22239	7.709235
2.87E-02	24.23757	23.1513	7.394406
3.94E-02	24.25134	23.22239	9.912973
0.039444	24.25593	23.23254	10.08788
5.46E-02	24.31562	23.50165	12.63147
5.48E-02	24.29267	23.56766	12.10678
0.0761677	24.32022	23.61843	15.25477
7.63E-02	24.32481	23.61843	15.56955
0.1085316	24.29726	23.78599	20.14811
0.1086339	24.30185	23.74537	19.93819
0.1507773	23.90238	22.91266	23.92528
0.151231	23.90238	22.91266	24.0302
0.2107824	23.90697	22.91266	30.84948
0.2109677	23.91157	22.91266	30.53472
0.2948079	23.89779	22.88727	37.84305
0.2948799	23.88861	22.76541	38.05285
0.4125288	23.8932	22.91266	47.70279
0.4126534	23.87483	22.93805	47.9475
0.5785227	23.91616	22.89743	59.69329
0.5787324	23.93452	22.88727	59.72825
0.8108859	23.95748	23.02436	75.03674
0.811534	23.9483	22.99898	74.68723
1.134874	24.03095	23.1513	94.41525
1.13488	24.03554	23.15638	94.32208
1.588519	24.08605	23.32902	115.1996
1.588725	24.08605	23.26809	115.4092
2.222112	24.19165	23.52704	146.6916

EHD Data for Idemitsu Kosan FVC32B Under R-410A Pressure (~20 wt%)
(T=23.4 ± 0.5°C, 9.70 bars; T=45°C, P=14.53 bars; T=65°C, P=19.84 bars)

2.222338	24.13196	23.51181	146.3087
2.223278	24.08605	23.37471	144.7065
2.224055	24.08146	23.36456	144.6367
3.106745	24.23757	23.73014	181.4788
3.108407	24.2743	23.79107	181.3352
3.111696	24.21002	23.6946	181.3352
slope=0.679			
2.84E-02	42.64059	44.95417	4.347722
2.85E-02	42.55335	44.93386	4.732518
2.86E-02	42.5258	44.95417	4.347722
2.86E-02	42.54417	44.92878	4.732518
3.92E-02	43.62319	45.83766	5.362175
3.93E-02	42.72324	45.89351	5.572078
0.0393621	43.70125	45.82243	5.362175
3.94E-02	42.76916	45.8732	6.096777
5.46E-02	43.22831	45.87587	6.586512
5.46E-02	42.89772	45.82355	7.251141
5.46E-02	43.2375	45.89111	7.041256
5.46E-02	43.2375	45.36572	6.936336
5.46E-02	42.75079	44.53273	6.726457
5.47E-02	42.78293	44.78661	6.726457
7.60E-02	42.68651	45.74626	9.197292
7.60E-02	42.82885	45.6244	9.698116
0.1091375	44.13285	45.88335	12.66967
0.1092364	44.11908	46.07122	12.45982
0.1517743	43.54972	45.45684	16.44724
0.1519435	43.57727	45.55331	16.3773
0.2122972	43.47626	45.3756	19.59505
0.2127036	43.35229	45.39083	19.59505
0.2969275	43.13189	45.31975	25.19081
0.297098	43.20536	45.39591	25.61047
0.4158385	43.00333	45.34006	32.60453
0.4158418	42.90231	45.06079	32.60453
0.4160136	43.00792	45.10142	32.81433
0.4160917	43.20536	45.69549	32.32481
0.4162391	42.87476	44.83231	32.60455
0.5821384	41.86921	44.78634	40.01749
0.5823206	42.69569	44.75615	40.15732
0.582338	42.88757	45.1113	39.52797
0.8143861	42.18507	45.157	48.12883
0.8144081	42.03354	44.76095	48.23373
0.8155327	42.63141	45.32483	48.2993
1.141763	40.76264	44.51723	59.66492
1.599123	43.93082	45.75669	72.69741
1.599691	43.82981	45.46219	73.11678
2.237327	42.43397	44.812	92.23059
2.24001	42.45693	44.61905	92.19565
3.132451	42.4753	44.46165	110.2213
3.132492	42.42479	44.61398	109.7323
3.133416	42.46611	44.55304	109.8371

EHD Data for Idemitsu Kosan FVC32B Under R-410A Pressure (~20 wt%)
(T=23.4 ± 0.5°C, 9.70 bars; T=45°C, P=14.53 bars; T=65°C, P=19.84 bars)

slope=0.695				
2.02E-02	60.51559	65.86847	2.965583	
2.81E-02	59.61564	64.35537	3.389236	
2.82E-02	60.05184	64.64986	3.389238	
3.93E-02	58.14174	64.42138	4.448328	
3.93E-02	58.04073	64.21828	3.95408	
5.52E-02	58.656	65.13223	5.295612	
5.52E-02	59.65237	65.5892	5.401557	
5.52E-02	58.70651	65.32517	5.295606	
7.74E-02	59.59268	65.54351	6.778395	
7.75E-02	59.70288	65.55367	6.566576	
0.0775946	59.77175	65.5892	6.778395	
0.1075098	59.77175	65.37087	8.967053	
0.107558	59.76716	65.39118	8.967053	
0.1076747	59.76716	65.35056	8.68465	
0.107751	59.77634	65.45719	8.825868	
0.1504862	59.57891	65.12715	11.43816	
0.1505453	59.7442	65.12207	11.22635	
0.1508379	59.72124	65.21347	11.22635	
0.2106462	59.46871	65.33533	14.47393	
0.2107565	59.62941	65.58413	14.12096	
0.2948025	59.73502	65.51812	18.49793	
0.2949327	59.75798	65.10684	18.49793	
0.2950478	59.73961	64.96975	18.42732	
0.2951042	59.75798	65.59428	18.85089	
0.4139321	59.74879	65.77708	23.79234	
0.4140705	59.77175	65.80754	23.93351	
0.5771084	59.81308	65.70599	30.49802	
0.5772544	59.80848	65.74153	30.42745	
0.8087571	59.83603	65.56889	38.33232	
0.8090876	59.84063	65.61459	38.33235	
1.132795	59.84981	65.26933	46.94203	
1.132846	59.84981	65.51305	46.51863	
1.587831	59.308	64.36044	58.12157	
1.588667	59.2024	64.24874	58.12157	
2.224571	59.13352	64.22335	71.17313	
2.225295	59.0922	64.27413	71.31423	
3.112233	59.18862	64.5517	87.60745	
3.113067	59.19321	64.5009	87.53693	
3.116285	59.15189	64.5761	87.60745	
slope=0.701				

EHD Data for Idemitsu Kosan FVC32B Under R-410A Pressure (~40 wt%)
(T=22.7 ± 0.7°C, P=14.05 bars; T=45°C, P=21.91 bars)

Software version	2		
Lubricant name	Idemitsu Kosan FVC32		
Viscosity	0		
Oil refractive index	1.439		
Spacer type	Silica		
Ball diameter	0.01905		
Disc track radius	0.04285		
Trigger point	232		
Comments	Idemitsu Kosan FVC32B under R-410A pressure		
6/15/98 Temperatur	45	65°C Load=20N	
M.R.=0.136 Trig. Pt.=232			
Avg. Band Top=237 Bottom=287			
Spacer Layer Film Thickness=459.3			
R.I.25°C=1.4394 45°C=1.4321 65°C=1.4256			
Disc #400			
Number of logged d	38		
Disc Speed (m/s)	Pot Temp (°C)	Lube Temp (°C)	Film (nm)
2.81E-02	23.76464	23.11068	2.307182
3.91E-02	24.1687	23.10053	2.936445
3.91E-02	24.13196	23.12084	2.796593
5.49E-02	24.15033	23.11068	3.565645
5.49E-02	24.17329	23.13099	3.355877
5.49E-02	24.07686	22.97359	3.3559
5.51E-02	24.09523	23.1513	3.565629
7.69E-02	24.18247	23.16653	4.614347
7.72E-02	23.91157	23.20716	4.614347
0.1085107	24.1687	23.24778	6.082464
0.1087305	24.17329	23.22746	5.942654
0.1509517	24.15492	23.28839	7.900166
0.1510683	24.15033	23.29855	7.76031
0.151236	24.14574	23.30871	7.760345
0.2105815	24.12737	23.1056	10.13721
0.2108097	24.14115	23.32394	10.06731
0.2955009	24.09523	23.27824	13.00336
0.2956482	24.11819	23.12084	13.31796
0.4131477	23.92993	23.21223	16.77815
0.4131829	23.47996	22.05456	16.98785
0.4132551	23.97585	23.16146	16.35875
0.4132612	23.49373	22.1358	16.68496
0.4133148	23.5121	22.10533	16.70826
0.5782362	23.52588	22.22212	21.01879
0.578403	23.39731	22.14088	21.25176
0.8094466	23.53047	22.34398	26.38907
0.8099748	23.54883	22.31351	26.35413
1.131801	23.58097	22.40998	31.98031
1.132731	23.57638	22.43029	31.70073
1.584335	23.81055	22.98882	38.65426
1.584979	23.6223	22.47091	38.58434
1.585327	23.62689	22.49122	38.58434
2.220581	23.6774	22.66894	46.96967
2.221042	23.72331	22.73495	46.76008
3.105955	23.92075	23.04975	55.87785

EHD Data for Idemitsu Kosan FVC32B Under R-410A Pressure (~40 wt%)
(T=22.7 ± 0.7°C, P=14.05 bars; T=45°C, P=21.91 bars)

3.105955	23.89779	23.0396	55.87785	
3.105955	23.92534	23.04467	55.87785	
3.106817	23.92075	22.96343	55.87785	
slope=0.695				

EHD Data for Idemitsu Kosan FVC32B Under R-410A Pressure (~40 wt%)
(T=22.7 ± 0.7°C, P=14.05 bars; T=45°C, P=21.91 bars)

Software version	2			
Lubricant name	Idemitsu Kosan FVC32			
Viscosity	0			
Oil refractive index	1.439			
Spacer type	Silica			
Ball diameter	0.01905			
Disc track radius	0.04285			
Trigger point	232			
Comments	Idemitsu Kosan FVC32B under R-410A pressure			
7/17/98 Temperature=45°C Load=20N				
M.R.=0.138 Trig. Pt.=464.8				
Avg. Band Top=237 Bottom=287				
Spacer Layer Film Thickness=464.8				
R.I.45°C=1.4321 65°C=1.4256				
Disc #408				
Number of logged data points				
Disc Speed (m/s)	Pot Temp (°C)	Lube Temp (°C)	Film (nm)	
0.2949477	43.75634	46.76684	8.57797	
0.2950729	43.75634	46.69068	8.437351	
0.2953528	43.78389	46.7313	8.437351	
0.4140999	43.50381	46.04583	11.39024	
0.4143401	43.41657	46.43681	11.39024	
0.4145044	43.60941	46.14738	11.39024	
0.4147965	43.37984	46.30987	11.17931	
0.5774998	43.20995	45.69549	15.64356	
0.5777709	42.81966	45.09126	15.50295	
0.5777765	43.10893	45.65487	15.32722	
0.5778645	42.62223	44.98971	15.6787	
0.577881	42.88854	45.30959	15.39751	
0.5779888	42.95282	45.45684	15.50295	
0.5783672	42.54417	44.84754	15.71386	
0.8095357	42.7636	45.04529	20.81054	
0.8100975	42.40642	44.82723	21.82986	
0.8104353	43.32474	45.95952	20.66995	
0.810563	42.1493	44.42611	21.09177	
0.8106282	42.65896	45.24866	21.4432	
1.134354	42.31	44.31948	25.73116	
1.135144	42.99414	45.49239	26.10605	
1.135489	42.90691	45.32991	26.2232	
1.589977	43.37984	45.41622	31.70573	
1.590062	43.27423	45.34514	31.8463	
2.226738	43.59564	45.13188	38.52316	
2.227372	43.46708	45.33498	38.17175	
3.113711	43.70125	45.53808	44.91829	
3.114561	43.72879	45.51777	45.48046	
3.117595	43.71502	45.51777	45.12911	
slope=0.712				

EHD Data for Idemitsu Kosan FVC68B Under R-410A Pressure (~15 wt%)
(T=24.2 ± 0.8°C, P=7.29 bars; T=45°C, P=10.46 bars; T=65°C, P=13.50 bars)

Software version	2		
Lubricant name	Idemitsu Kosan FVC68		
Viscosity	0		
Oil refractive index	1.428		
Spacer type	Silica		
Ball diameter	0.01905		
Disc track radius	0.04213		
Trigger point	466		
Comments	Idemitsu Kosan FVC68B under R-410A pressure		
6/11/98 Temperatur	45	65°C Load=20N	
M.R.=0.143 Trig. Pt.=466			
Avg. Band Top=234 Bottom=287			
Spacer Layer Film Thickness=471.2			
R.I.25°C=1.4420 45°C=1.4350 65°C=1.4281			
Disc #400			
Number of logged d	113		
Disc Speed (m/s)	Pot Temp (°C)	Lube Temp (°C)	Film (nm)
1.07E-02	25.04568	24.03987	8.531586
1.36E-02	25.06864	24.11603	9.577778
1.36E-02	25.07323	24.11095	9.263913
1.36E-02	25.05946	24.08557	9.577778
1.97E-02	25.07783	24.13634	12.19352
1.98E-02	25.07323	24.14142	12.40277
1.99E-02	25.0916	24.13126	12.40277
2.73E-02	25.11456	24.20743	16.01092
2.75E-02	25.05946	24.23281	15.17401
2.75E-02	25.10997	24.2125	15.17401
4.00E-02	25.16507	24.2582	19.5679
4.01E-02	25.15129	24.24805	19.5679
0.0552219	25.19262	24.3496	24.79842
5.53E-02	25.13293	24.33944	24.37999
7.70E-02	25.22017	24.41053	29.40095
7.71E-02	25.22476	24.41053	28.98255
7.73E-02	25.21098	24.41053	30.02856
0.1079577	25.24771	24.69487	38.07964
0.1079893	25.22017	24.73549	38.49798
0.1087378	25.2569	24.53239	38.7071
0.1494573	25.24771	24.76595	45.60941
0.1501491	25.12374	24.79642	46.2369
0.2097722	25.21098	24.9132	61.36359
0.2097741	25.22017	24.90812	61.03833
0.2098503	25.19721	24.96398	61.36359
0.294565	25.18343	25.10615	84.08221
0.2946331	25.16047	25.08076	84.01254
0.4123357	24.61408	23.46103	111.1659
0.4123999	24.60489	23.44072	111.0963
0.5776039	24.58194	23.36964	146.6089
0.5779076	24.57275	23.37471	146.5393
0.8081033	24.65081	23.61336	191.8363
0.8082572	24.63704	23.57274	191.6456
1.131538	24.6554	23.67429	237.5192
1.132021	24.66918	23.70475	237.6145
1.132454	24.63704	23.61336	237.6622

EHD Data for Idemitsu Kosan FVC68B Under R-410A Pressure (~15 wt%)
(T=24.2 ± 0.8°C, P=7.29 bars; T=45°C, P=10.46 bars; T=65°C, P=13.50 bars)

1.585366	24.77478	24.1008	297.0076
1.585562	24.74264	23.95863	299.2669
2.21911	24.91712	24.59332	353.9129
2.220241	24.89416	24.44607	355.7287
2.221372	24.85743	24.31913	356.9392
3.104903	25.16507	25.10107	409.1395
3.105838	25.15588	25.15692	409.3815
3.106069	25.06405	25.02491	410.2285
slope=0.718			
1.03E-02	43.33392	44.83739	4.529073
0.0106417	44.05939	45.65487	4.529073
1.37E-02	43.03088	45.75642	5.370201
1.37E-02	43.25127	45.60409	5.370201
1.97E-02	44.40835	46.11692	6.842217
1.97E-02	44.53691	46.14738	6.842217
2.00E-02	44.36702	46.06107	6.526801
2.74E-02	43.64615	44.79676	8.155231
2.75E-02	43.62319	44.95417	7.944975
2.76E-02	43.55891	44.90339	7.944975
4.00E-02	44.87669	46.62467	10.60848
4.01E-02	44.90424	46.61452	10.25802
5.55E-02	42.75998	45.20297	12.71113
5.55E-02	42.81507	45.23851	12.36068
7.72E-02	43.20536	45.68025	16.14552
7.72E-02	43.18699	45.73611	15.93522
7.73E-02	43.05383	45.63456	16.21555
0.1081352	43.36147	45.90874	20.35053
0.1082803	43.46708	45.8732	20.49065
0.1083846	43.3982	45.89351	19.93002
0.1496098	43.63696	46.14738	24.76545
0.1497624	43.60482	46.19816	24.48516
0.1500402	43.66451	46.03568	25.08086
0.2101715	43.58187	45.50254	33.805
0.2108835	43.46708	45.6701	33.38464
0.2953882	43.16862	45.14204	44.52476
0.2955159	43.26505	45.17758	44.62984
0.4133361	43.51758	45.8732	57.01616
0.4135344	43.40279	45.82243	56.94609
0.5794063	43.13648	45.55839	74.66528
0.5796021	43.25127	45.69549	74.38515
0.8102098	42.94823	45.14711	95.74023
0.8110203	43.02169	45.41114	95.60022
1.135358	42.78293	44.92878	122.6172
1.135662	42.81507	45.07095	121.9874
1.589338	42.89313	44.74599	165.0282
1.589984	42.77834	44.74091	165.0282
2.226429	43.06761	44.99479	203.4705
2.22687	42.99874	44.73584	204.0456
3.111577	43.16403	45.16235	243
3.111839	43.16403	45.10142	243.1437
3.113598	42.97119	45.19789	242.8563

EHD Data for Idemitsu Kosan FVC68B Under R-410A Pressure (~15 wt%)
(T=24.2 ± 0.8°C, P=7.29 bars; T=45°C, P=10.46 bars; T=65°C, P=13.50 bars)

slope=0.721			
0.0105217	61.05939	65.65487	2.418541712
1.37E-02	61.03088	65.75642	2.89874479
1.37E-02	61.25127	65.60409	2.908148097
1.97E-02	60.40835	65.11692	3.732875031
2.00E-02	60.36702	65.06107	3.769257914
2.75E-02	60.62319	65.95417	4.703064456
2.76E-02	60.55891	65.90339	4.724380737
4.00E-02	60.87669	65.62467	6.110028587
4.01E-02	60.90424	65.61452	6.113614871
5.55E-02	60.75998	65.20297	7.660017691
5.55E-02	60.81507	65.23851	7.666676338
7.72E-02	61.20536	65.68025	9.631469753
7.72E-02	61.18699	65.73611	9.633536512
0.1086133	61.49359	64.99568	11.78739
0.1086183	61.62675	65.0363	11.78739
0.1496527	59.86818	64.95932	15.9077
0.1499149	59.80848	65.17766	15.16817
0.1504293	59.89573	65.1675	15.87247
0.1504947	59.61105	65.18273	16.01331
0.2096978	59.43198	64.8273	18.97127
0.2101812	59.40443	64.92378	19.04171
0.2951459	59.2024	64.86285	24.14756
0.295776	59.3631	64.98471	23.83064
0.2957893	59.308	65.01009	24.887
0.4136344	59.08761	65.41657	31.91247
0.4136534	59.40902	65.64506	31.66598
0.5796621	58.77538	64.72603	42.26264
0.5801907	58.56417	64.47215	42.36824
0.8104019	58.4402	64.99487	56.20124
0.8110073	58.41265	64.79684	56.62357
1.135221	58.64222	64.60897	76.41771
1.135677	58.54121	64.68006	76.2594
1.591174	59.94164	64.81235	99.30228
1.591436	59.74879	64.6651	99.82983
2.228217	60.24009	65.39118	122.243
2.228285	60.05643	64.99513	123.2509
2.229284	60.13449	65.22363	122.7586
3.114077	59.53758	64.22335	159.3814
3.1176	59.59268	64.42138	158.8996
3.117792	59.73961	64.63463	157.3578
slope=0.740			

EHD Data for Idemitsu Kosan FVC68B Under R-410A Pressure (~20 wt%)
(T=22.5 ± 0.5°C, P=10.12 bars; T=45°C, P=15.50 bars; T=65°C, P=19.08 bars)

Software version	2		
Lubricant name	Idemitsu Kosan FVC68		
Viscosity	0		
Oil refractive index	1.426		
Spacer type	Silica		
Ball diameter	0.01905		
Disc track radius	0.0448		
Trigger point	369		
Comments	Idemitsu Kosan FVC68B under R-410A pressure		
7/21/98 Temperatu	65°C Load=20N		
M.R.=0.138 Trig. Pt.=369			
Avg. Banded Top=237 Bottom=287			
Spacer Layer Film Thickness=456.7			
R.I.25°C=1.4420 45°C=1.4350 65°C=1.4261			
Disc #408			
Number of logged d	134		
Disc Speed (m/s)	Pot Temp (°C)	Lube Temp (°C)	Film (nm)
9.40E-03	23.47078	22.27797	4.631355
9.46E-03	23.52128	22.31351	4.631355
1.44E-02	23.51669	22.3846	6.315476
1.44E-02	23.52128	22.39983	6.104934
1.44E-02	23.50292	22.37952	6.315476
1.91E-02	23.47537	22.43537	7.47326
1.92E-02	23.49833	22.41506	7.297842
1.93E-02	23.52128	22.40491	7.578522
2.74E-02	23.52128	22.44045	9.367769
2.75E-02	23.52128	22.43029	9.683498
3.90E-02	23.5121	22.46584	13.05148
3.90E-02	23.50751	22.48615	12.84099
5.54E-02	23.47996	22.56739	16.41925
5.54E-02	23.50751	22.56231	16.41924
7.67E-02	23.51669	22.57754	20.10263
7.70E-02	23.5121	22.53692	19.36599
0.1080884	23.47996	22.67402	26.2061
0.1081101	23.41568	22.67909	25.67993
0.1081844	23.47078	22.65878	25.67997
0.1507498	23.48914	22.72987	33.18592
0.150783	23.48455	22.7451	33.46649
0.2116599	23.45241	22.73495	42.09389
0.2117141	23.47996	22.7451	41.77825
0.2951604	23.45241	22.72987	53.0344
0.295384	23.45241	22.70448	52.82402
0.4137316	23.12182	21.83115	65.65592
0.4137744	23.09427	21.82099	65.58582
0.4140677	23.19069	21.92254	65.76109
0.5785607	23.15855	21.9327	82.9717
0.578722	23.17691	21.97332	82.76145
0.8086876	23.20906	22.01394	105.889
0.8090069	23.19069	21.97332	105.4687
1.132991	23.20906	22.07995	130.3706
1.133456	23.21824	22.16626	130.0904
1.585126	23.33303	22.47091	170.6274

EHD Data for Idemitsu Kosan FVC68B Under R-410A Pressure (~20 wt%)
(T=22.5 ± 0.5°C, P=10.12 bars; T=45°C, P=15.50 bars; T=65°C, P=19.08 bars)

1.587148	23.3468	22.48107	170.5795
2.221457	23.38354	22.6334	203.686
2.221894	23.38354	22.5877	204.2616
3.110961	23.42945	22.76541	241.7695
3.11188	23.39272	22.72987	241.8654
slope=0.695			
0.019193	43.45789	45.77673	4.420884
1.92E-02	44.00429	46.27432	4.841916
2.75E-02	44.7619	45.54316	5.578652
2.76E-02	44.51855	45.37053	5.683897
2.76E-02	44.7619	45.61425	5.683898
3.92E-02	44.22469	44.99479	7.789003
3.92E-02	44.33488	44.8577	7.789004
5.55E-02	43.65074	44.84246	9.473022
0.0555385	43.6186	44.95417	9.788763
5.56E-02	43.38902	44.65459	9.473022
7.69E-02	42.87017	45.533	12.20949
7.70E-02	43.0722	45.51777	12.42002
0.1076827	43.25127	45.5127	15.26159
0.1081471	43.09057	45.47715	15.15636
0.1508902	43.15485	45.45684	18.59422
0.1514254	43.0722	45.40607	18.94501
0.2115555	42.97578	45.28421	23.71565
0.2118759	42.97119	45.22836	23.7858
0.295247	42.94364	45.08111	31.99341
0.2953404	42.92068	45.09634	32.30907
0.4134654	43.55891	45.42638	41.04181
0.4135205	43.46249	45.22836	41.18207
0.5776098	43.69206	45.38576	50.93059
0.5783372	43.75175	45.54316	50.7202
0.8079926	43.89869	45.95444	61.86974
0.8081667	43.79767	45.6701	62.00996
1.132304	44.15581	46.46219	76.10202
1.132839	44.07316	46.28955	76.17212
1.586403	42.6911	45.05064	98.98231
1.586417	42.69569	45.03033	99.26263
2.223439	42.67273	44.83739	119.5474
2.223884	42.75079	44.94909	119.3723
3.110898	42.79671	44.96432	146.4796
3.111471	42.8564	45.03541	146.5964
3.112479	42.75998	44.9237	146.3395
slope=0.689			
7.71E-02	59.48708	64.67386	6.990848
7.72E-02	59.48708	64.86018	6.990848
0.1083335	59.48248	64.82971	8.261805
0.108341	60.40998	64.85297	8.47363
0.1507814	60.16204	64.85804	11.43922
0.1510121	60.20795	64.65495	11.65108

EHD Data for Idemitsu Kosan FVC68B Under R-410A Pressure (~20 wt%)
(T=22.5 ± 0.5°C, P=10.12 bars; T=45°C, P=15.50 bars; T=65°C, P=19.08 bars)

0.1511605	60.19418	64.57878	12.07473
0.21316	60.07383	64.66963	13.66338
0.2132	59.89017	64.77626	13.76929
0.2976216	59.62749	64.61405	19.9118
0.297684	59.06828	64.55312	19.06457
0.4166612	59.95253	65.67979	27.04214
0.4169681	59.08568	65.8118	27.11275
0.5822743	59.58061	65.03494	35.79538
0.5825741	59.64489	65.03184	36.14829
0.813725	59.49796	65.30378	46.91181
0.8146591	59.49337	65.20731	46.87651
1.13362	61.13086	66.69102	58.34404
1.133968	61.11249	66.79765	58.37932
1.140254	59.77586	65.40079	59.43777
1.587216	59.96209	65.58385	72.7728
1.588073	59.51003	64.90374	72.7728
2.225463	59.90597	65.17258	91.99466
2.226214	59.96465	64.95424	92.45313
3.112608	59.93913	64.69529	112.5817
3.114388	59.83352	64.98358	112.7228
slope=0.783			

EHD Data for Idemitsu Kosan FVC68B Under R-410A Pressure (~30 wt%)
(T=22.5 ± 0.7°C, P=13.63 bars; T=45°C, P=19.77 bars)

Software version	2		
Lubricant name	Idemitsu Kosan FVC68		
Viscosity	0		
Oil refractive index	1.435		
Spacer type	Silica		
Ball diameter	0.01905		
Disc track radius	0.04095		
Trigger point	426		
Comments	Idemitsu Kosan FVC68B under R-410A pressure		
8/10/98 Temperature	45	65°C Load=20N	
M.R.=0.145 Trig. Pt.=426			
Avg. Band Top=237 Bottom=287			
Spacer Layer Film Thickness=494.5			
R.I.25°C=1.4420 45°C=1.4350 65°C=1.4261			
Disc #418			
Number of logged d	85		
Disc Speed (m/s)	Pot Temp (°C)	Lube Temp (°C)	Film (nm)
9.96E-03	23.7279	22.71971	1.884541
9.99E-03	23.75545	22.76033	1.884541
1.45E-02	23.81514	22.87712	2.442913
1.47E-02	23.70495	22.86696	2.442913
2.05E-02	23.87483	22.93297	3.210716
2.05E-02	23.88402	22.92789	3.350268
2.80E-02	23.87943	23.00406	4.187871
2.80E-02	23.87483	22.9939	4.048291
2.80E-02	23.88861	23.01929	4.048291
3.85E-02	23.87024	23.01929	4.816046
3.85E-02	23.91157	23.01421	5.025454
3.86E-02	23.86565	23.00406	5.095169
5.52E-02	23.91616	23.01929	6.700484
5.52E-02	23.87943	23.06499	6.840059
5.53E-02	23.92993	23.07514	6.281721
7.62E-02	23.91616	23.08022	8.375499
7.63E-02	23.93452	23.05991	8.166144
7.63E-02	23.92075	23.0396	8.305697
7.64E-02	23.93452	23.08022	8.584888
7.64E-02	23.93452	23.04467	7.852057
0.1076293	23.95748	23.13099	10.4692
0.1077293	23.95289	23.1056	10.46924
0.1077942	23.97126	23.1056	10.74837
0.1495701	23.94371	23.17161	13.19094
0.150101	23.91157	23.09037	12.84202
0.2100608	23.93452	23.197	16.26152
0.2101869	23.96667	23.20716	16.54065
0.2102367	23.96207	22.96343	15.9126
0.2958995	23.94371	23.19192	21.14623
0.2959727	23.95748	23.20716	21.14623
0.2961039	23.5672	22.81619	21.35553
0.2961589	23.57638	22.86696	20.79729
0.4133315	23.7325	22.99898	26.51895
0.4133911	23.71413	22.91266	27.21671
0.4134884	23.8381	23.04975	26.72826
0.4134897	23.7279	22.97359	26.72828

EHD Data for Idemitsu Kosan FVC68B Under R-410A Pressure (~30 wt%)
(T=22.5 ± 0.7°C, P=13.63 bars; T=45°C, P=19.77 bars)

0.4135439	23.79678	23.01929	26.58872
0.5785823	23.53965	22.86188	35.10052
0.5790622	23.86106	22.97867	33.35643
0.5791262	23.783	23.04467	33.35643
0.5791466	23.87943	23.08022	34.12385
0.5793028	23.81055	23.1056	34.19364
0.8091379	23.70035	22.85173	46.61071
0.8092542	22.94734	21.87684	45.84343
0.8096836	23.90238	23.1513	42.91371
0.8097132	23.93452	23.11068	42.91371
0.8097305	23.92075	23.17161	42.98347
1.133967	23.1861	22.34398	57.07285
1.134647	23.14937	22.30843	56.93335
1.134938	23.92993	23.12592	55.25952
1.135166	23.93452	23.17161	55.18976
1.587527	23.1861	22.43537	70.42709
1.588138	23.13559	22.35921	70.53168
2.223843	23.27334	22.52169	85.84081
2.224221	23.31466	22.59278	85.91049
3.108597	23.31925	22.65878	106.891
3.108918	23.35139	22.71464	106.8909
slope=0.706			
0.1078697	41.48352	45.51777	9.108305
0.1079944	41.7085	45.61932	8.584849
0.1080066	41.96104	45.9189	9.212978
0.1505547	42.36969	45.80211	10.4692
0.1508416	42.40642	45.84781	11.02753
0.151028	42.1998	45.73103	10.88793
0.2112436	41.93349	45.43145	13.67944
0.2115752	42.0391	45.31467	13.40028
0.2118727	42.01155	44.84246	14.86579
0.2969281	41.58453	44.9694	16.75
0.2970953	41.61208	44.99479	16.64532
0.4140491	41.94267	45.33498	23.23953
0.4141658	42.0391	45.32483	23.23954
0.5788288	42.02991	44.57335	29.03076
0.5788558	42.11256	44.88308	29.03076
0.8096538	42.49366	45.2639	36.21675
0.809808	42.70488	45.50254	36.147
1.135044	42.95741	45.87828	45.35519
1.136114	43.05843	46.10169	45.07615
1.58997	43.17321	45.81495	57.77024
1.591487	43.25127	45.80479	58.04918
2.227157	43.19158	46.16262	71.46137
2.22856	43.26964	45.8794	71.43813
2.228622	42.76916	45.56855	73.41119
2.229133	42.8013	45.67517	73.41118
2.229746	42.80589	45.97475	72.78364
3.110854	42.75538	45.28421	88.78391
3.113384	42.74161	45.29944	88.88845
slope=0.697			

EHD Data for Idemitsu Kosan FVC68B Under R-410A Pressure (~50 wt%)
(T=22.3 ± 0.3°C, P=14.88 bars; T=45°C, P=23.36 bars)

Software version	2			
Lubricant name	Idemitsu Kosan FVC68			
Viscosity	0			
Oil refractive index	1.435			
Spacer type	Silica			
Ball diameter	0.01905			
Disc track radius	0.0448			
Trigger point	369			
Comments	Idemitsu Kosan FVC68B under R-410A pressure			
7/21/98 Temperatu	65°C Load=20N			
M.R.=0.138 Trig. Pt.=369				
Avg. Bamsd Top=237 Bottom=287				
Spacer Layer Film Thickness=456.7				
R.I.25°C=1.4420 45°C=1.4350 65°C=1.4261				
Disc #408				
Number of logged d	149			
Disc Speed (m/s)	Pot Temp (°C)	Lube Temp (°C)	Film (nm)	
5.57E-02	23.82433	22.60293	3.14256	
5.57E-02	23.81973	22.62832	3.142536	
5.58E-02	23.81973	22.56231	2.828292	
5.58E-02	23.84728	22.51154	3.142544	
7.71E-02	23.80596	22.65371	3.666311	
7.71E-02	23.80596	22.62832	3.771056	
7.71E-02	23.74168	22.65371	3.77107	
0.1082827	23.70954	22.42522	4.818546	
0.1083314	23.63148	22.39475	4.818546	
0.1083963	23.65444	22.40998	4.678877	
0.1509232	23.61771	22.51154	6.168628	
0.150971	23.58097	22.48107	6.261747	
0.1511032	23.70954	22.39983	6.424677	
0.1511163	23.61771	22.45061	6.075517	
0.2115448	23.54424	22.51154	8.379972	
0.2117396	23.6774	22.56231	8.170474	
0.2954138	23.66821	22.55215	11.20802	
0.2955454	23.63148	22.55723	10.96362	
0.4136965	23.67281	22.56739	13.82646	
0.4139728	23.66362	22.56231	13.82646	
0.4146594	23.68658	22.44553	14.03601	
0.4146954	23.69117	22.48615	13.96616	
0.5781258	23.64985	22.55723	17.62028	
0.5781938	23.63607	22.55215	17.73666	
0.5796666	23.71872	22.48615	17.7367	
0.8087003	23.53047	22.01394	23.25242	
0.8087506	23.48455	22.06979	22.97317	
0.8098054	23.64526	22.54708	22.55425	
0.8099656	23.72331	22.67402	22.69391	
1.132793	23.50292	22.1358	27.99987	
1.133578	23.5121	22.08502	28.06967	
1.586092	23.5121	22.32874	34.1432	
1.586152	23.52588	22.27289	34.07338	
1.589203	23.79219	22.6994	33.30548	
2.222663	23.54883	22.40491	41.75176	
2.222953	23.52128	22.38968	41.47261	
slope=0.734				

EHD Data for Idemitsu Kosan FVC68B Under R-410A Pressure (~50 wt%)
(T=22.3 ± 0.3°C, P=14.88 bars; T=45°C, P=23.36 bars)

0.4136916	44.19254	44.96405	9.473022
0.4143998	44.49559	45.21285	9.964172
0.5792486	44.78849	45.2687	13.06322
0.5795236	44.2706	44.62413	13.06322
0.8106845	43.65992	44.20778	17.58194
0.8107851	43.33851	44.83712	17.79372
0.8114751	44.54513	45.15192	17.58193
1.133951	44.09153	44.84727	23.5124
1.134438	44.57824	44.52766	23.22998
1.587551	44.82618	45.0151	28.27755
1.588973	44.94556	45.30959	28.31284
2.227597	43.64615	44.12653	34.93953
2.227631	44.35784	45.24359	35.78128
2.228636	44.01807	44.77645	35.57088
3.115179	44.59201	45.69549	46.09156
3.120476	44.66548	45.88335	45.56557
slope=0.751			